

Panasonic®

Operating Instructions **Vol.2**

Memory Card Camera-Recorder

Model No. **AG-DVX200PJ**
AG-DVX200PB
AG-DVX200PX
AG-DVX200EJ
AG-DVX200EN
AG-DVX200ED

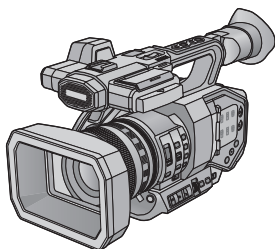

Vol.2

This document explains in detail how to operate this device. Concerning basic operation, please refer to the enclosed "Operating Instructions Vol.1" (printed document).

Please read these instructions carefully before using this product, and save this manual for future use.

AVCHD™
Progressive

HDMI™

SD™ **XC** **I**

DOLBY
DIGITAL

LEICA
DICOMAR

PJ **PB** **PX** **EJ** **EN** **ED**

W0815YA4078 -FJ

ENGLISH

SQT1051-4

Read this first

■ About the recording method for recording motion pictures

This unit can record motion pictures using three different recording methods, including MOV, MP4 and AVCHD. (→ 33, 150)

* AVCHD Progressive (1080/60p, 1080/50p) supported.

MOV and MP4:

These recording methods are suitable for editing images. Audio is recorded in linear PCM.

- Those methods are not compatible with motion pictures recorded in AVCHD format.
- Those methods can record motion pictures in formats that support 4K. 4K motion pictures offer a resolution four times higher than that of full high-definition motion pictures.

AVCHD:

This recording method is suitable for playback on a high-definition compatible external monitor. Audio is recorded in Dolby® Digital.

■ Regarding system frequencies

The NTSC/PAL region setting can be switched in [SYSTEM FREQ]. (→ 150, 188)

- You cannot store AVCHD scenes recorded with different system frequencies on the same SD card. If you have switched the system frequency, use another SD card.

■ Indemnity about recorded content

Panasonic does not accept any responsibility for damages directly or indirectly due to any type of problems that result in loss of recording or edited content, and does not guarantee any content if recording or editing does not work properly. Likewise, the above also applies in a case where any type of repair is made to the unit.

■ About Condensation (When the lens, the viewfinder or LCD Monitor is fogged up)

Condensation occurs when there is a change in temperature or humidity, such as when the unit is taken from outside or a cold room to a warm room. Please be careful, as it may cause the lens, the viewfinder or LCD monitor to become soiled, moldy, or damaged.

When taking the unit to a place which has a different temperature, if the unit is accustomed to the room temperature of the destination for about one hour, condensation can be prevented. (When the difference in temperature is severe, place the unit in a plastic bag or the like, remove air from the bag, and seal the bag.) When condensation has occurred, remove the battery and/or the AC adaptor and leave the unit like that for about one hour. When the unit becomes accustomed to the surrounding temperature, fogginess will disappear naturally.

■ About security

Be careful about the possibility of theft or loss of the unit, and be careful not to leave the unit unattended. Please note that Panasonic does not accept any responsibility for the compromise, manipulation, and loss of information caused by these events.

■ Caution regarding laser beams

The lens may suffer damage if struck by a laser beam. Make sure that laser beams do not strike the lens when shooting in an environment where laser devices are used.

■ Caution regarding the lens and the viewfinder



Do not aim the lens or the viewfinder at the sun or strong light. Doing so may cause your camcorder to malfunction.

■ Cards that you can use with this unit

SDHC Memory Card and SDXC Memory Card

- 4 GB or more Memory Cards that do not have the SDHC logo or 48 GB or more Memory Cards that do not have the SDXC logo are not based on SD Memory Card Specifications.
- Refer to page 21 for more details on SD cards.

■ For the purposes of these operating instructions

- The battery pack is referred to as the "Battery".
- SDHC Memory Card and SDXC Memory Card are referred to as the "SD card".
- Function that can be used for Recording Mode: 
Function that can be used for Playback Mode: 
- Scene(s) recorded with [REC MODE] set to [MOV] or [MP4]: "MOV/MP4 scene(s)".
- Scene(s) recorded with [REC MODE] set to [AVCHD]: "AVCHD scene(s)".
- Pages for reference are indicated by an arrow, for example: → 00
- These operating instructions are designed for use with models AG-DVX200PJ/PB/PX/EJ/EN/ED. Such as screen illustrations are as an example AG-DVX200PJ.

Contents

Read this first	2
-----------------------	---

Preparation

What you can do with this unit	6
Recording to the SD card	6
Linking to external devices	6
Remote operations with an iPad	7
Names and Functions of Main Parts	8
Power supply	15
Charging the battery	16
Inserting/removing the battery	17
Charging and recording time	18
Connecting to the AC outlet	20
Preparation of SD cards	21
Cards that you can use with this unit	21
Inserting/removing an SD card	22
Turning the unit on/off	23
Selecting a mode	23
Using the LCD monitor/Viewfinder	24
Setting how to turn on/off the LCD monitor and Viewfinder	24
Using the LCD monitor	24
How to use the touch screen	25
LCD monitor adjustment	26
Viewfinder adjustment	27
Recording yourself	28
Setting date and time	29
Using the menu screen	30

Recording

Before recording	31
Selecting the Recording Method	31
Formatting media	32
Selecting a media to record	32
Recording motion picture with this unit	33
Recording still pictures	34
Switching between Auto and Manual Mode	36
Adjusting the Picture Quality	38
Using the zoom	40
Image Stabilizer Function	42
Focus	44
One Push AF	47
Push AF	48

Focus Assist	48
Manual Focus Assist	51
Focus Transition	52
White Balance	55
Iris/Gain adjustment	59
Iris adjustment	59
Gain adjustment	61
Manual shutter speed	64
Audio Input	67
Switching Audio Input	67
Adjusting the audio input level	69
Counter display	71
Setting the Time Code	71
Setting the User Information	73
Setting the Recording Counter	74
Synchronizing the time code with an external device	74
USER button	75
Setting the USER button	75
Using the USER button	76
Functions of the USER button	77
Useful functions	96
Color Bar Screen	96
ND filter	97
Switching the screen indications/mode information display	97
Using Operation Icons	98
Using of jog dial	99

Playback

Motion picture/Still picture playback	102
Motion picture playback using operation icon	106
Useful functions	107
Creating still picture from motion picture	107
Repeat Playback	108
Resuming the previous playback	108
Playing back scenes or still pictures by date	109

Editing

Deleting scenes/still pictures	110
Protecting scenes/still pictures	111
Copying between SD cards	112

Linking to external devices

Connecting Headphones, a Remote Control or an External Monitor	114
Headphones	114
Remote control	114
External monitor	115
Setting the external output resolution	116
Connecting to a PC (File transfer/nonlinear editing)	122
Operating environment (mass storage).....	122
Connecting to a PC	123
About the PC display	124
Copying/playing back with an external media device	126
Preparing for copying/playing back	126
Copy once	128
Copy selected files	129
Playing back the External Media	130
Using an iPad as a Remote Control (AG ROP application)	131
Before connection.....	131
Connecting this unit and an iPad	134
Operations during AG ROP application connection	138

Menu

Using the Menu	139
Scene file	139
System mode.....	150
User switch	159
Switch setting	160
Auto switch setting.....	168
Recording Setup	170
Audio Setup	177
Output Setup	178
Display setting	182
Other Functions	187
NETWORK SETUP	190
Maintenance	191
Video Setup	192
Picture Setup	192
Copy	193

Display

Indications	194
Messages	197
Warning Indications	201

Others

Troubleshooting	204
About recovery.....	208
Updating the firmware incorporated into the unit	208
Cautions for use	209
About copyright	213
Recording functions that cannot be used simultaneously	214
Recording modes/approximate recordable time	215
Approximate number of recordable pictures	217

What you can do with this unit

This unit is a 4K*¹ camera recorder with the following features:

*¹ Please refer to page 151 about recording format of this unit.

- The 4/3-type large sensor allows you to record beautifully defocused images with shallow depth of field as ultra high-definition 4K motion picture.
- V-Log L (12 stops) allows you to record expressive images with greater latitude.
- Recording at a variable frame rate of up to 120 fps (for FHD) is possible.
- It incorporates the 5-Axis Hybrid Image Stabilizer, Custom AF function, and ND filters (1/4, 1/16, and 1/64).
- Supported recording media include SDHC Memory Card and SDXC Memory Card.

Recording to the SD card

A variety of recording functions support recording to the SD card.

- This unit supports relay/simultaneous/background/dual codec recording using double card slots.

Linking to external devices

USB Device Mode

Transfer data (files) to perform nonlinear editing on another device (PC, etc.).

- This unit supports USB 3.0.

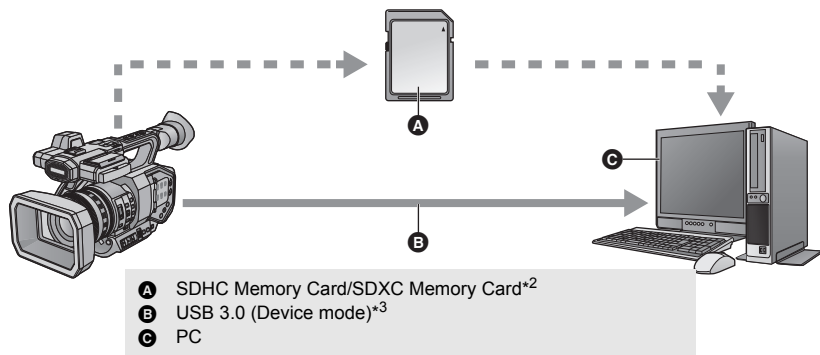

*² SD cards are optional and not supplied with this unit.

*³ A USB 3.0 cable is not supplied with this unit. Use a commercially-available double-shielded USB 3.0 cable with a ferrite core.

If possible, we recommend using a cable with a length of 1.5 m (4.9 feet) or less.

USB Host Mode

If you connect an external media device, such as USB HDD or USB flash memory (commercially-available) to this unit, you can copy motion pictures and still pictures recorded on this unit to the external media device.

It can also play back the scenes and still pictures copied to the external media device.

- This unit supports USB 3.0.

Refer to the following support site for information about an external media device.

<https://pro-av.panasonic.net/>

(This Site is English only)

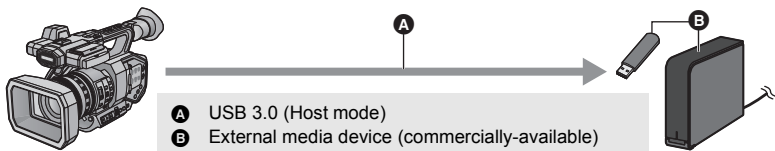

Connecting to an external monitor

Connect an external monitor to output images.

- It is also possible to output 4:2:2 (10 bit) images, depending on the [OUTPUT BITS] setting.

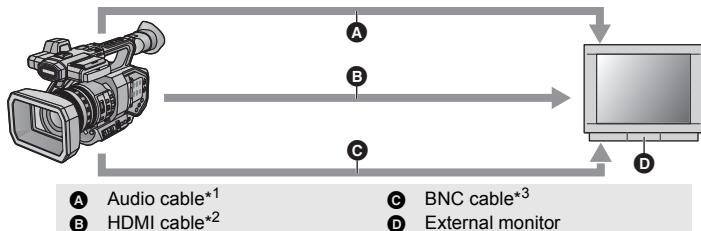

*¹ Use a commercially-available audio cable (3.5 mm (0.14 ") diameter jack to RCA cable).

*² Use a commercially-available High Speed HDMI cable.

If possible, we recommend using a cable with a length of 3 m (9.84 feet) or less.

*³ To connect to the SDI OUT or VIDEO OUT terminal, use a double-shielded BNC cable equivalent to 5C-FB (commercially-available).

When connecting with an HDMI cable using an HDMI-to-DVI converter, etc., be sure to connect the HDMI cable to the connector of this unit last.

Connecting the HDMI cable to the connector of this unit first may result in malfunction.

Remote operations with an iPad

Attaching a wireless module that support this unit (→ 132) to the USB HOST terminal of this unit allows you to connect to a wireless LAN network. You can perform the following operations by connecting this unit and an iPad on which the AG ROP application is installed:

- Checking the camera status
- Playing back scenes recorded as sub recordings with [DUAL CODEC REC] set to [FHD 8Mbps] and checking the thumbnails of these scenes
- Controlling the camera remotely (recording control and Time Code/User Information operations)

Names and Functions of Main Parts

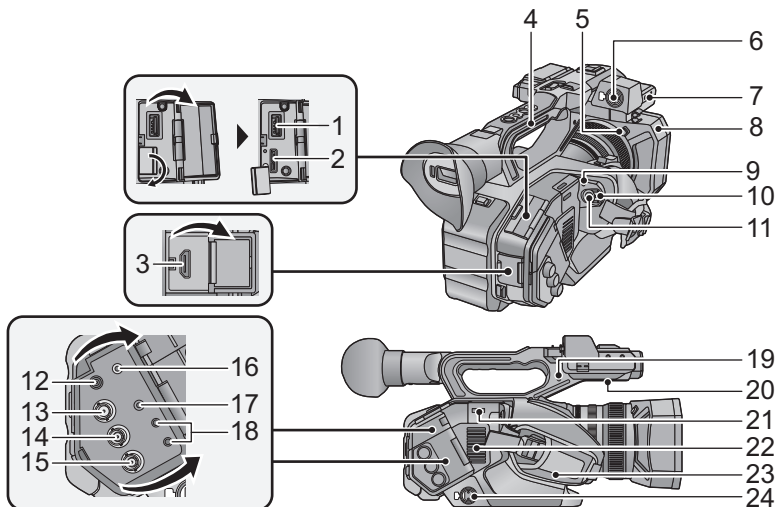

- 1 **USB HOST terminal** (→ 126, 131)
- 2 **USB DEVICE terminal** (→ 123)
- 3 **HDMI OUT connector [HDMI]** (→ 115)
- 4 **Handle**
- 5 **Lens hood release button** (→ 12)
- 6 **Audio input terminal 1 (XLR 3 pin) [AUDIO INPUT1]** (→ 14, 68)
- 7 **Microphone holder attachment part** (→ 14)
- 8 **Lens hood** (→ 12)
- 9 **Status indicator** (→ 23)
- 10 **Power switch** (→ 23)
- 11 **Recording start/stop button** (→ 33)
- 12 **DC input terminal [DC IN]** (→ 20)
 - Do not use any other AC adaptors except the supplied one.
- 13 **SDI OUT terminal** (→ 115)
- 14 **TC PRESET IN/OUT terminal** (→ 74)
- 15 **VIDEO OUT terminal** (→ 115)
- 16 **Headphone terminal** [] (→ 101, 114)
 - Excessive sound pressure from earphones and headphones can cause hearing loss.
 - Listening at full volume for long periods may damage the user's ears.
- 17 **AUDIO OUT terminal** (→ 115)
- 18 **Camera remote terminal [CAM REMOTE]** (→ 114)
 - FOCUS IRIS terminal (3.5 mm (0.14 ") diameter mini jack)
 - ZOOM S/S terminal (2.5 mm (0.1 ") diameter super mini jack)
- 19 **Pin holder**
 - Attaches the zoom ring pin removed from this unit.
- 20 **Speaker**
- 21 **Shoulder strap fixture** (→ 13)
- 22 **Inlet (cooling fan)** (→ 31)
- 23 **Hand strap** (→ 13)
- 24 **Audio input terminal 2 (XLR 3 pin) [AUDIO INPUT2]** (→ 14, 68)

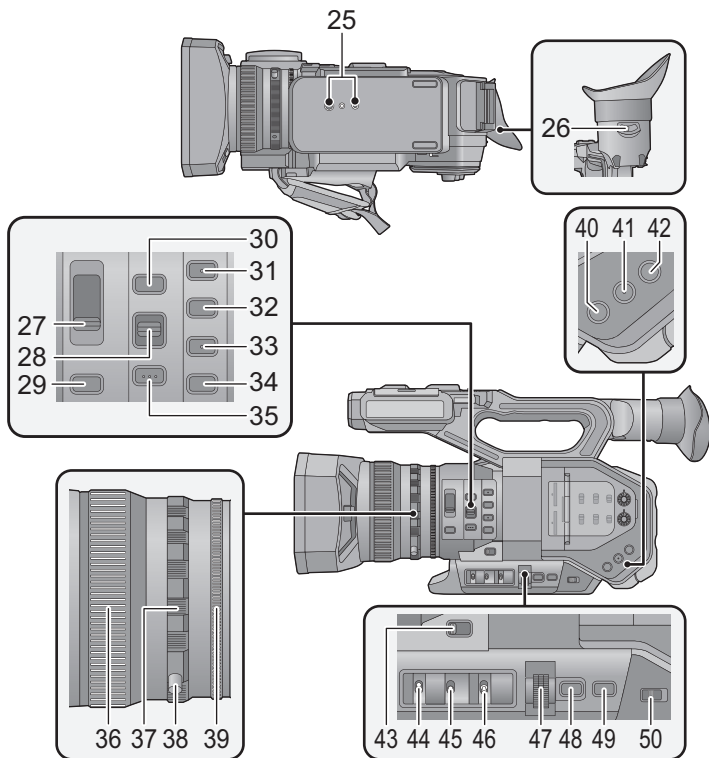

- 25 Tripod receptacle (→ 14)
- 26 Eyepiece corrector lever (→ 27)
- 27 ND filter switch [ND FILTER] (→ 97)
- 28 Focus auto/Manual/∞ switch [FOCUS A/M/∞] (→ 44)
- 29 Iris button [IRIS] (→ 59)
- 30 FOCUS ASSIST button (→ 48)
- 31 User 1 button [USER1] (→ 75)
- 32 User 2 button [USER2] (→ 75)
- 33 User 3 button [USER3] (→ 75)
- 34 User 4 button [USER4] (→ 75)
- 35 PUSH AUTO button (→ 44)
- 36 Focus ring (→ 44)
- 37 Zoom ring (→ 40)
- 38 Zoom ring pin
- 39 Iris ring (→ 59)
- 40 User 5 button [O.I.S.] (→ 42, 75)
- 41 User 6 button [ZEBRA] (→ 75, 88)
- 42 User 7 button [WFM] (→ 75, 87)
- 43 Zoom switch [MANU/SERVO] (→ 40)
- 44 Display/Mode check switch [DISP/MODE CHK] (→ 76, 97)
- 45 Gain switch [GAIN] (→ 61)
- 46 White Balance switch [WHITE BAL] (→ 55)
- 47 Jog dial [SEL/PUSH SET] (→ 55, 61, 64, 99, 104)
- 48 Menu button [MENU] (→ 30)
- 49 Shutter speed button [SHUTTER] (→ 64)
- 50 Auto/Manual switch [AUTO/MANU] (→ 36)

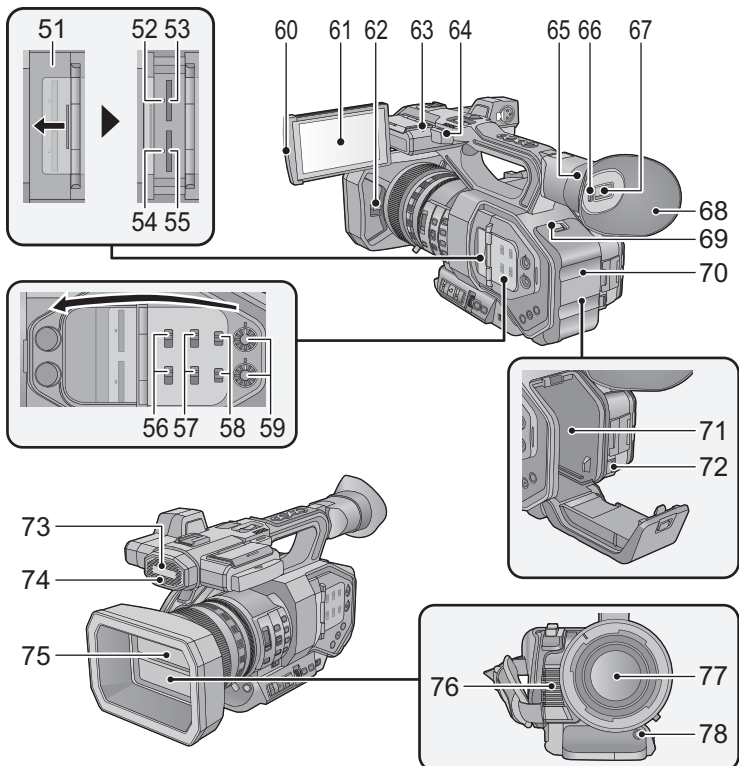

- | | |
|--|--|
| 51 SD Card slot cover (→ 22) | 65 Eye cup mount (→ 13) |
| 52 Access lamp (card 1) (→ 22) | 66 Eye sensor (→ 28) |
| 53 Card slot 1 (→ 22) | 67 Viewfinder (→ 27) |
| 54 Access lamp (card 2) (→ 22) | 68 Eye cup (→ 13) |
| 55 Card slot 2 (→ 22) | 69 Open/close lever [OPEN] (→ 17) |
| 56 INPUT1 / INPUT2 switches (→ 67) | 70 Battery cover (→ 17) |
| 57 CH1 SELECT/CH2 SELECT switches (→ 67) | 71 Battery holder (→ 17) |
| 58 CH1/CH2 switches (→ 67) | 72 Battery release lever [BATTERY] (→ 17) |
| 59 AUDIO LEVEL CH1/AUDIO LEVEL CH2 knobs (→ 69) | 73 Built-in microphone |
| 60 LCD monitor extract part (→ 24) | 74 Recording lamp (Front) (→ 188) |
| 61 LCD monitor (Touch screen) (→ 25) | 75 Lens cover (→ 12) |
| 62 Lens cover open/close lever (→ 12) | 76 Exhaust opening (cooling fan) (→ 31) |
| 63 Recording lamp (Rear) (→ 188) | 77 Lens (LEICA DICOMAR) |
| 64 Shoulder strap fixture (→ 13) | 78 Auto white balance button [AWB] (→ 55, 76) |
- This button is used as a USER button.

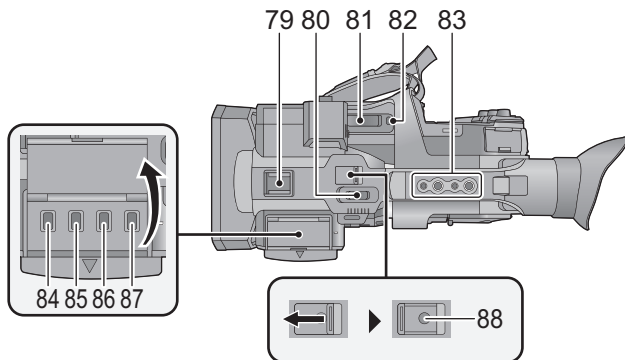

79 Accessory shoe

80 Sub zoom lever (→ 40, 167)

- This lever functions in the same manner as the zoom lever.

81 Zoom lever [T/W] (In Recording Mode) (→ 40)

Volume lever [+VOL-]/

Thumbnail display switch [Q/] (In Playback Mode) (→ 104)

82 User 8 button [REC CHECK] (→ 75, 80)

83 Handle mounting hole

(Size of the mounting hole)

- 1/4-20UNC×2
- 3/8-16UNC×2

84 Thumbnail button [THUMBNAIL] (→ 23)

85 Counter button [COUNTER] (→ 71)

86 Counter reset/Time code setting button [RESET/TC SET] (→ 73, 74)

87 Color Bar Screen button [BARS] (→ 96)

88 Sub recording start/stop button (→ 167)

- This button functions in the same manner as the recording start/stop button.

■ Attaching/detaching the lens hood

(How to detach the lens hood)

While pressing and holding the lens hood release button, rotate the lens hood in the direction of the arrow to detach it.

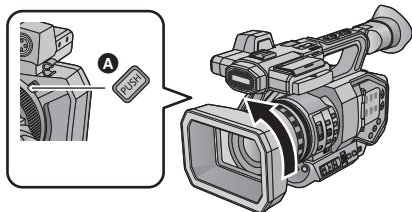

A Lens hood release button

(How to attach the lens hood)

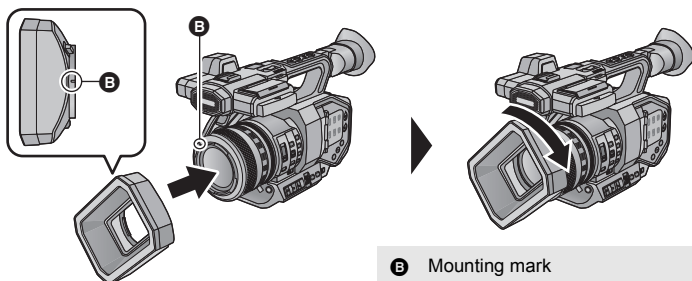

B Mounting mark

1 Fit the lens hood into this unit.

- Align the mounting mark on the lens hood with the mounting mark on this unit.

2 Rotate the lens hood in the direction of the arrow.

- Rotate until it clicks into place.

Opening/closing the lens cover

You can open/close the lens cover by sliding the lens cover open/close lever.

- When this unit is not in use, close the lens cover to protect the lens.

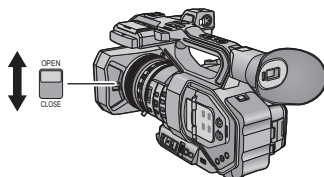

-
- Do not press the lens cover hard. This may damage the lens or the lens cover.
 - Depending on the various filters or the MC protector attached to the front side of this unit's lens, you may not be able to open/close the lens cover or attach the lens hood.

■ Adjust the length of the hand strap so that it fits your hand.

Adjust the hand strap according to the size of your hand.

- If you find it difficult to fasten the buckle **B**, move the pad **A** towards you, and fasten the buckle **B** again.

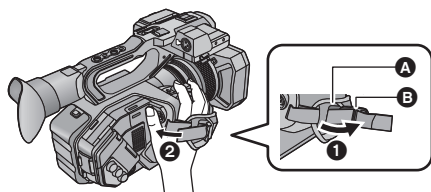

- 1 Open the buckle.
- 2 Pull the end of the belt.

■ Attaching the eye cup

- 1 Align the mounting mark on the eye cup mount with the corresponding mark on the eyecup.
- 2 Attach the eye cup so that the notch on the eye cup mount is aligned with the protrusion inside the eye cup.

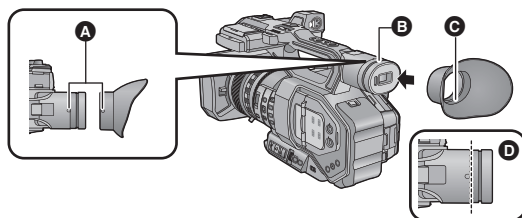

- A** Mounting marks
- B** Notch
- C** Protrusion

- Push the eye cup in until it reaches the mounting mark. **(D)**

■ Attaching the Shoulder strap

We recommend that you attach the shoulder strap (supplied) before going out of doors to record so as to avoid dropping this unit.

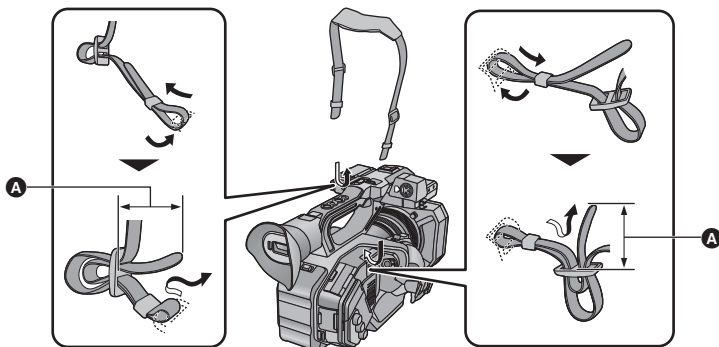

- A** 20 mm (0.8 ") or longer

■ Attaching the front microphone

- The microphone holder is set up so that a 21 mm (0.83 ") external microphone (AG-MC200G: optional) can be attached. Check in advance whether the microphone you wish to use can be attached.

1 Attach the microphone holder to the microphone holder attachment part.

- Attach by using a commercially available screw driver.
- When attaching the microphone holder, be sure to tighten the screws firmly even though you might hear a squeaking sound.

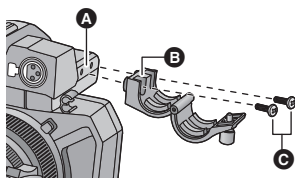

- A** Microphone holder attachment part
- B** Microphone holder
- C** Microphone holder mounting screws

2 Attach an external microphone (optional) to the microphone holder, and tighten the microphone holder screw.

3 Connect the external microphone to the AUDIO INPUT1 terminal (XLR 3 pin).

- When wiring the microphone cable, use the cable clammer of this unit.
- Keep the microphone holder screw, zoom ring pin and INPUT terminal cap out of reach of children to prevent swallowing.

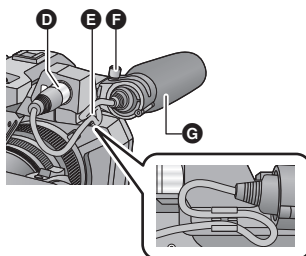

- D** AUDIO INPUT1 terminal (XLR 3 pin)
- E** Microphone cable clammer
- F** Microphone holder screw
- G** External microphone (optional)

■ Attaching the INPUT terminal cap

Attach the INPUT terminal cap while the AUDIO INPUT1, 2 terminals (XLR 3 pin) are not used.

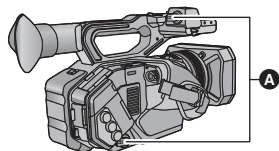

- A** INPUT terminal cap

■ Attaching the tripod

- There are tripod mounting holes that are compatible with 1/4-20UNC and 3/8-16UNC screws. Use the size that matches the diameter of the tripod's fixing screw.

- Attaching a tripod with a screw length of 5.5 mm (0.22 ") or more may damage the unit.

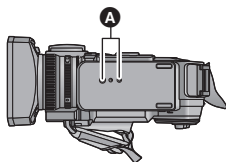

A Tripod receptacle

Preparation

Power supply

■ About batteries that you can use with this unit (as of October 2018)

The battery that can be used with this unit is VW-VBD58/AG-VBR59/AG-VBR89/AG-VBR118.

It has been found that counterfeit battery packs which look very similar to the genuine product are made available to purchase in some markets. Some of these battery packs are not adequately protected with internal protection to meet the requirements of appropriate safety standards. There is a possibility that these battery packs may lead to fire or explosion. Please be advised that we are not liable for any accident or failure occurring as a result of use of a counterfeit battery pack. To ensure that safe products are used we would recommend that a genuine Panasonic battery pack is used.

Charging the battery

When this unit is purchased, the battery is not charged. Charge the battery fully before using this unit for the first time.

Important:

- Do not use the AC cable with any other equipment as it is designed only for this unit. Also, do not use the AC cable from other equipment with this unit.
- It is recommended to charge the battery in a temperature between 10 °C and 30 °C (50 °F and 86 °F). (The battery temperature should also be the same.)

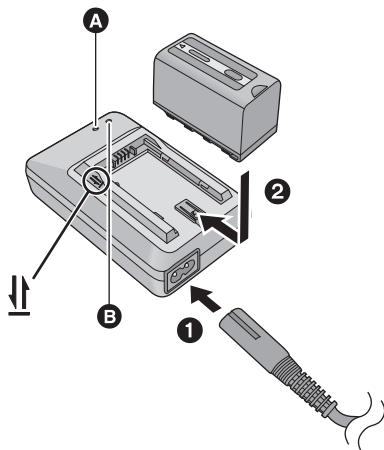

Charging lamp [CHARGE] **A**

Lights up:

Charging (Battery charging time: → 18)

Goes off:

Charging completed

Flashing:

Be sure to connect the unit correctly (→ 211)

Power lamp [POWER] **B**

- This will light up when the AC cable is connected.

- Insert the plugs as far as they will go.

1 Connect the AC cable to the battery charger and the AC outlet.

2 Insert the battery into the battery charger by aligning the arrows.

- We recommend using Panasonic batteries (→ 18).
- If you use other batteries, we cannot guarantee the quality of this product.
- Do not heat or expose to flame.
- Do not leave the battery(ies) in a car exposed to direct sunlight for a long period of time with doors and windows closed.

Inserting/removing the battery

- 1** Slide the open/close lever, and open the battery cover.

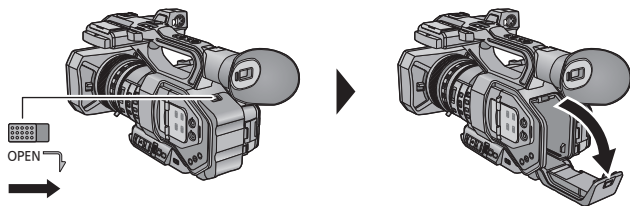

- 2** Install the battery by inserting it in the direction shown in the figure.

- Insert the battery until it clicks and locks.

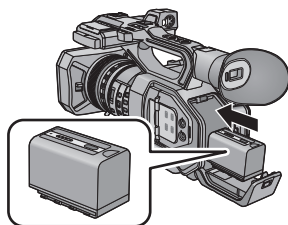

- 3** Close the battery cover.

- Close the battery cover until it clicks and locks.

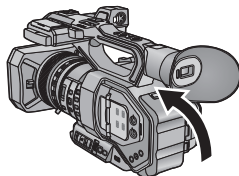

Removing the battery

Make sure that the power switch is set to OFF and the status indicator is turned off, and then remove by holding onto it taking care not to drop. (→ 23)

Open the battery cover, and slide the battery release lever.

- The battery will be unlocked, allowing you to take it out.
- Slide the battery release lever in the direction indicated by the arrow.

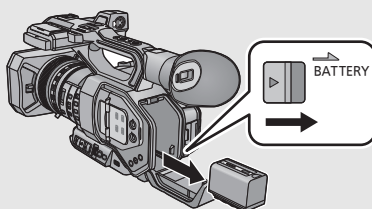

Charging and recording time

Charging/Recording time

Battery model number	Voltage/Capacity (minimum)	Charging time	Continuously recordable time
Supplied battery/ AG-VBR59 (optional)	7.28 V/5900 mAh	385 min	AG-DVX200PJ/PB/PX: 160 min AG-DVX200EJ/EN/ED: 170 min

- The times given apply when the ambient operating temperature is 20 °C (68 °F) and the relative operating humidity is 60%. Charging time may be longer at other temperatures and humidity levels.
- The continuous recordable time given applies under the conditions below. The time becomes shorter under other conditions.
 - The LCD monitor is open
 - A cable is not inserted to the external output terminal
- "h" is an abbreviation for hour, "min" for minute and "s" for second.
- These times are approximations.
- **The indicated charging time is for when the battery has been discharged completely. Charging time and recordable time vary depending on the usage conditions such as high/low temperature.**
- The AG-VBR59 (supplied) is a battery pack that supports quick charging. It is possible to perform quick charging by using the optional AG-BRD50 for charging.



-
- The batteries heat up after use or charging. This is not a malfunction.

Checking the remaining power of the battery

You can check the remaining power of the battery by looking at the battery capacity indication displayed on this unit's screen or by looking at the supplied battery AG-VBR59.

■ Checking the remaining power using this unit

Battery capacity indication

- The display changes as the battery capacity reduces.  If the battery discharges, then  will flash red.

- Depending on the menu setting, the battery capacity indication is not displayed (→ 185)
[DISP SETUP] → [CARD & BATTERY]

■ Checking the remaining power using the battery

If you press the CHECK button when charging is not in progress, the indicator (LED lamps) will light in green so that you can check the remaining power of the battery.

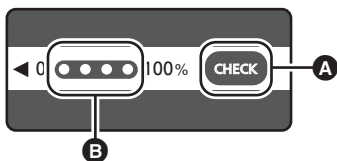









- A** CHECK button
- B** Indicator
- The remaining power of the battery is an approximate guide.
- When the LED lamp does not light up even if you press the CHECK button, the battery is exhausted. Charge the battery.

How to read the indicator

An approximate guide of the charging progress is indicated by the flashing position of the LED lamps when charging is in progress. The LED lamps turn off when charging is complete.

:Flashing in green/ :Lit in green/ :Off

LED lamp status		Remaining power of the battery / Charging progress
When checking the remaining power	During charging	
		0% to 25%
		25% to 50%
		50% to 75%
		75% to 100%

- The display of the indicator is an approximate guide. When the battery pack is connected to the video camera or the charger, refer to the remaining power display of the connected device. The display of the connected device may differ from that of the battery pack's indicator.

Connecting to the AC outlet

The unit is in the standby condition when the AC adaptor is connected. The primary circuit is always "live" as long as the AC adaptor is connected to an electrical outlet.

Important:

- Use the supplied AC adaptor. Do not use the AC adaptor of another device.
- Do not use the AC cable with any other equipment as it is designed only for this unit. Also, do not use the AC cable from other equipment with this unit.

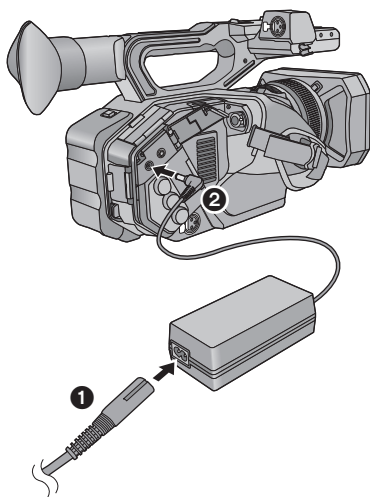

1 Connect the AC cable to the AC adaptor and the AC outlet.

2 Connect the AC adaptor to the DC input terminal [DC IN].

- Make sure to set the power switch to OFF and the status indicator is turned off when disconnecting the AC adaptor. (→ 23)

- Insert the plugs as far as they will go.

-
- Even when you use the AC adaptor for recording images, keep the battery connected. This allows you to continue the recording even if a power failure occurs or the AC adaptor is unplugged from the AC outlet by accident.

Preparation of SD cards

The unit can record motion pictures or still pictures to an SD card.

Cards that you can use with this unit

- The cards that you can use are correct as of October 2018.
- We recommend that you use a Panasonic Memory Card.

Card type	Capacity
SDHC Memory Card	4 GB to 32 GB
SDXC Memory Card	48 GB to 128 GB

- **When using an SDHC Memory Card/SDXC Memory Card with other equipment, check the equipment is compatible with these Memory Cards.**
- We do not guarantee the operation of SD cards other than the ones above.
- 4 GB or more Memory Cards that do not have the SDHC logo or 48 GB or more Memory Cards that do not have the SDXC logo are not based on SD Memory Card Specifications.
- This unit is compatible with UHS-I UHS Speed Class3 standard SDHC/SDXC Memory Cards.
- When the write-protect switch **A** on SD card is locked, no recording, deletion or editing will be possible on the card.
- Keep the Memory Card out of reach of children to prevent swallowing.

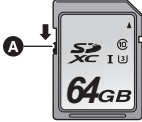

■ About the Speed Class ratings for recording motion pictures

- Depending on [REC MODE] (→ 150) and [REC FORMAT] (→ 151), the required card differs. Use a card that meets the following ratings of the SD Speed Class or UHS Speed Class. Use of a non-compatible card may cause recording to stop suddenly.
- SD Speed Class and UHS Speed Class are the speed standards regarding continuous writing. To check the class, see the labelled side, etc. of the card.
- We recommend that you use an SD card compatible with UHS Speed Class3 when recording in Variable Frame Rate Mode.

Recording modes	Bit rates in [REC FORMAT]	Speed Class ratings	Label examples
MOV/MP4	100 Mbps or more	UHS Speed Class3*	U3
	50 Mbps	UHS Speed Class1 or more	U1
		Class10 or more	CLASS10
AVCHD	All	Class4 or more	CLASS4

* When [UHD 2160/59.94p 150M] or [UHD 2160/50.00p 150M] is selected, an SDXC Memory Card with a capacity of 64 GB or more and a Speed Class rating of UHS Speed Class3 is required.

Inserting/removing an SD card

When using an SD card for the first time, it is necessary to format the SD card. (→ 32) When the SD card is formatted, all of the recorded data is deleted. Once the data is deleted, it cannot be restored.

Caution:

Check that the access lamp has gone off.

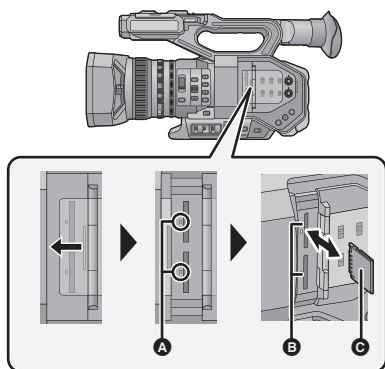

Access lamp **A**

- When this unit is accessing the SD card, the access lamp lights up.

1 Open the SD card slot cover and insert (remove) the SD card into (from) the card slot **B**.

- One SD card can be inserted into each of the card slot 1 and the card slot 2.
- Face the terminal side **C** in the direction shown in the illustration and press it straight in as far as it will go.
- Press the center of the SD card and then pull it straight out.

2 Securely close the SD card slot cover.

- Do not touch the terminals on the back of the SD card.
- Do not apply strong shocks, bend, or drop the SD card.
- Electrical noise, static electricity or the failure of this unit or the SD card may damage or erase the data stored on the SD card.
- When the card access lamp is lit, do not:
 - Remove the SD card
 - Turn the unit off
 - Insert and remove the USB Cable
 - Expose the unit to vibrations or shockPerforming the above while the lamp is on may result in damage to data/SD card or this unit.
- Do not expose the terminals of the SD card to water, dirt or dust.
- Do not place SD cards in the following areas:
 - In direct sunlight
 - In very dusty or humid areas
 - Near a heater
 - Locations susceptible to significant difference in temperature (condensation can occur.)
 - Where static electricity or electromagnetic waves occur
- To protect SD cards, return them to their cases when you are not using them.
- About disposing of or giving away the SD card. (→ 211)

Turning the unit on/off

Set the power switch to ON while pressing the lock release button **B** to turn on the unit.

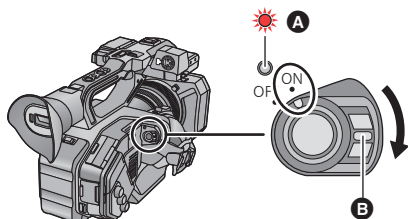

To turn off the unit

Set the power switch to OFF while pressing the lock release button. The status indicator goes off.

A The status indicator lights on.

- To turn on the unit again after the [ECONOMY (BATT)] or [ECONOMY (AC)] is activated, set the power switch to OFF once, and then to ON again. (→ 188)

Selecting a mode

Press the THUMBNAIL button to change the mode to Recording Mode or Playback Mode.

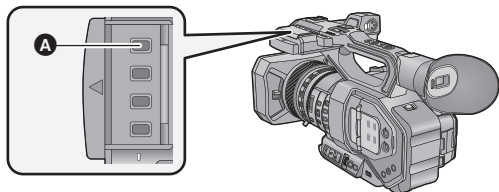

A THUMBNAIL button

Recording Mode (→ 33, 34)	The recording screen is displayed. You can record motion pictures and still pictures.
Playback Mode (→ 102)	The thumbnail screen for playback is displayed. You can play back motion pictures and still pictures.

- When you turn on this unit, it starts up in Recording Mode.
- If you press the recording start/stop button or sub recording start/stop button in Playback Mode, the mode will be switched to Recording Mode and recording will start.

Using the LCD monitor/Viewfinder

Setting how to turn on/off the LCD monitor and Viewfinder

Select the menu. (→ 30)

 : [OUTPUT SETUP] → [LCD/EVF OUTPUT] → desired setting

- [AUTO]:** The LCD monitor is turned on when the LCD monitor is extracted. When you move your eye closer to the eye cup of the viewfinder, the LCD monitor is turned off, and the viewfinder is turned on.
- [LCD]:** The LCD monitor is turned on when the LCD monitor is extracted. The viewfinder is not turned on.
- [EVF]:** The viewfinder turns on when you move your eye closer to the eye cup of the viewfinder and turns off when you move your eye away from it. The LCD monitor does not turn on.

■ To change the setting with a USER button

You can change how to turn on/off the LCD monitor and Viewfinder by registering “LCD/EVF Output” to a USER button.

- Please refer to page 75 for details about setting the USER button.

When the recording screen is displayed, press the USER button to which [LCD/EVF OUTPUT] is registered or touch the applicable USER button icon.

- Switches the setting each time the button is pressed.
[AUTO] → [LCD] → [EVF]
- The setting is also applied to the [LCD/EVF OUTPUT] menu setting.

- The viewfinder turns on as soon as [EVF] is selected and stays on. It reacts to the eye sensor and turns on/off only after you move your eye closer to the eye cup of the viewfinder.
- Depending on the shape of your glasses or the way you hold this unit, or when bright light enters the eyepiece, the eye sensor may not work correctly.
- You can turn on/off the viewfinder by registering [EVF ON/OFF] to a USER button.

Using the LCD monitor

1 Extract the LCD monitor in the direction as indicated in the figure.

- Hold the LCD monitor extract part **A**, and extract the LCD monitor until it clicks into position.

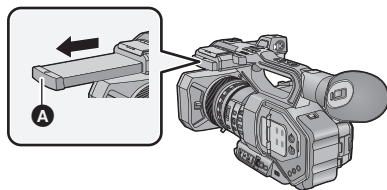

2 Rotate to the position that is easy to view.

To retract the LCD monitor

Retract as shown in the figure with the LCD facing downward.

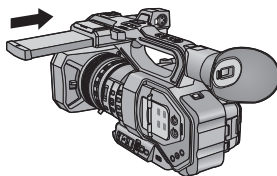
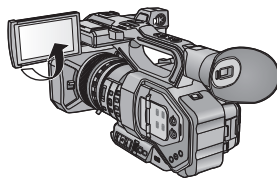

Range of rotation of the LCD monitor

- It can rotate up to 270° towards the lens.

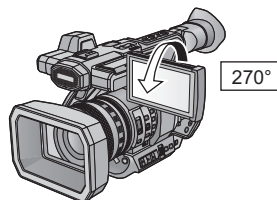

How to use the touch screen

You can operate by directly touching the LCD monitor (touch screen) with your finger.

■ Touch

Touch and release the touch screen to select icon or picture.

- Touch the center of the icon.
- Touching the touch screen will not operate while you are touching another part of the touch screen.

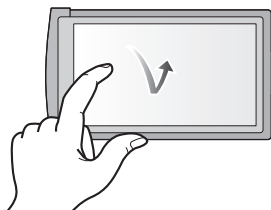

■ Slide while touching

Move your finger while pressing on the touch screen.

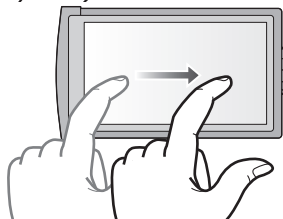

■ About the operation icons



Touch when changing a page or performing settings.

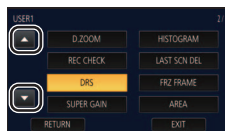

- Do not touch the LCD monitor with hard pointed tips, such as ball point pens.

LCD monitor adjustment

- These settings will not affect the images actually recorded.

[LCD BACKLIGHT]

Brightness of the LCD monitor can be switched.

Select the menu. (→ 30)

 : [DISP SETUP] → [LCD BACKLIGHT] → desired setting

[HIGH]/[LOW]

- [LOW] is selected when:
 - [USB MODE SELECT] is set to [DEVICE] and this unit is connected to a PC. (→ 123)
- When the [LCD/EVF OUTPUT] is set to [EVF], this item cannot be set. (→ 24)

[LCD SET]

It adjusts brightness and color density on the LCD monitor.

1 Select the menu. (→ 30)

 : [DISP SETUP] → [LCD SET]

2 Touch the desired setting item.

[COLOR]: Color level of the LCD monitor

[BRIGHTNESS]: Brightness of the LCD monitor

[CONTRAST]: Contrast of the LCD monitor

3 Touch  /  to adjust settings.

- You can select a value between -16 and +16.

4 Touch [RETURN].

- Touch [EXIT] to exit the menu screen.

- When the [LCD/EVF OUTPUT] is set to [EVF], this item cannot be set. (→ 24)

Viewfinder adjustment

- These settings will not affect the images actually recorded.

Adjusting the field of view

It adjusts the field of view to show the image on the viewfinder clearly.

1 Adjust the viewfinder to suit your vision so that you can see the display images clearly.

- Be careful not to trap your fingers when moving the viewfinder.

- The viewfinder can be lifted vertically up to approximately 90°.

- Turn on the viewfinder.

2 Adjust the focus by operating the eyepiece corrector lever.

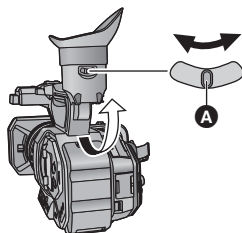

A Eyepiece corrector lever

[EVF SETTING]

It adjusts brightness and color density of the viewfinder.

- Use the jog dial to change the settings. (→ 99)

1 Select the menu. (→ 30)

 : [DISP SETUP] → [EVF SETTING] → desired setting

[COLOR]: Color level of the viewfinder

[BRIGHTNESS]: Brightness of the viewfinder

[CONTRAST]: Contrast of the viewfinder

2 Rotate the jog dial to move the cursor to the value display **A**.

- Push the jog dial to select the value display.

3 Rotate the jog dial to adjust the setting.

- Pushing the jog dial will set the value you have selected.
- You can select a value between -16 and +16.

4 Select [RETURN].

- Select [EXIT].



- When the [LCD/EVF OUTPUT] is set to [LCD], this item cannot be set. (→ 24)
- When [COLOR] is set to -16, images are displayed in black and white.

[EVF COLOR]

The recording images or playback images on the viewfinder can be selected between color/black and white.

Select the menu. (→ 30)

 : [DISP SETUP] → [EVF COLOR] → [ON] or [OFF]

[ON]: Displayed in color

[OFF]: Displayed in black and white

- If you adjust the [COLOR] setting in [EVF SETTING], [EVF COLOR] will be set to [ON].

[EYE SENSOR]

It adjusts sensitivity of eye sensor.

1 Select the menu. (→ 30)

 : [DISP SETUP] → [EYE SENSOR]

2 Touch  /  to adjust settings.

- You can select a value between -4 and +4.

3 Touch [EXIT] to complete the setting.

- When the [LCD/EVF OUTPUT] is set to [LCD], this item cannot be set. (→ 24)

Recording yourself

- Change the mode to Recording Mode. (→ 23)

Rotate the LCD monitor towards the lens side.

- Displaying during the recording yourself can be switched by setting [SELF SHOOT]. (→ 186)

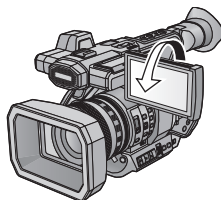

- Only some indications will appear on the screen when the [SELF SHOOT] is set to [MIRROR]. When  appears, return the direction of the LCD monitor to normal position and check the warning/alarm indication. (→ 197)
- The LCD monitor display changes as follows when Self Shoot is used:
 - The viewfinder image is displayed.
 - The display size becomes smaller.

Setting date and time

When this unit is turned on, the message [SET TIME ZONE AND DATE/TIME] may appear. To make these settings, select [YES], and follow the instructions from Step 2-3 of the time zone setting procedure.

1 Select the menu. (→ 30)

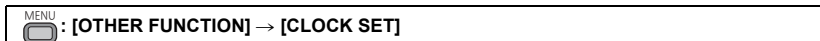

2 Touch the date or time to be set, then set the desired value using ▲/▼.

- The year can be set between 2000 and 2039.

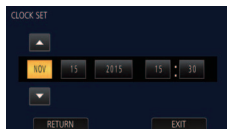

3 Touch [EXIT] to complete the setting.

- The date and time function is driven by a built-in lithium battery.
- If the time display becomes [- -], the built-in lithium battery needs to be charged. To recharge the built-in lithium battery, connect the AC adaptor or attach a charged battery to this unit. Leave the unit as it is for approx. 24 hours and the battery will maintain the date and time for approx. 6 months. (The battery is still being recharged even if the unit is off.)
- The way that time is displayed can be changed in the menu settings. (→ 184)
[DISP SETUP] → [DATE/TIME] or [DATE FORMAT]

Time zone

Time difference from the Greenwich Mean Time can be set.

1 Select the menu. (→ 30)

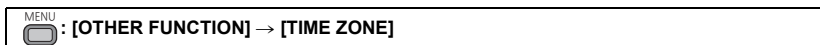

2 Touch ◀/▶ and set the region to record.

3 Touch [EXIT] to complete the setting.

- If the [CLOCK SET] screen appears, perform [CLOCK SET].
- When the time zone setting is changed, the date/time setting of the unit also changes automatically.

Using the menu screen

- You can also select menu items by operating the jog dial. (→ 99)

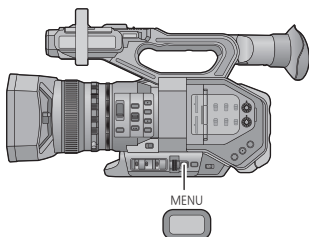

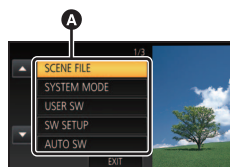

1 Press the MENU button .

2 Touch the top menu **A**.



3 Touch the submenu **B**.

- Next (Previous) page can be displayed by touching  / .

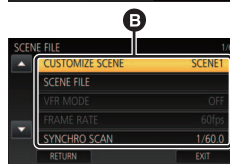

4 Touch the desired item to enter the setting.

5 Touch [EXIT] to exit the menu setting.

Before recording

- When recording, make sure your footing is stable and there is no danger of colliding with another person or object.
- Hold the eye cup of the viewfinder as close as possible to your eye.
- Adjust the angle of the LCD monitor according to the position in which the unit is held.
- When you are outdoors, record pictures with the sunlight behind you. If the subject is backlit, it will become dark in the recording.
- Keep your arms near your body and separate your legs for better balance.
- For stable images, it is recommended to use a tripod whenever possible.
- Do not block the cooling fan inlet or the exhaust opening with your hand or other objects.



Selecting the Recording Method

When recording to the SD card with this unit, set [OUTPUT BITS] to [4:2:2(8bit)].

When recording with an external device connected via the HDMI OUT/SDI OUT terminal, you can change the picture quality of images output to the device by changing the [OUTPUT BITS] setting.

Select the menu.

MENU  : [SYSTEM MODE] → [OUTPUT BITS] → **desired setting**

[4:2:2(10bit)]: Allows you to output high quality images using an HDMI/SDI connection. This setting is suitable for recording with an external device that supports HDMI/SDI output. You cannot record these images with this unit.

[4:2:2(8bit)]: Allows you to output the image being recorded with this unit.

- When [4:2:2(10bit)] is selected,  and **REC** are displayed on the screen.
- The setting method of the picture quality of the image changes depending on the [OUTPUT BITS] setting.
 - When [4:2:2(10bit)] is selected, change the [OUTPUT FORMAT] setting. (→ 157)
 - When [4:2:2(8bit)] is selected, change the [REC MODE] and [REC FORMAT] settings. (→ 150, 151)

- This function is not available in the following cases:

- During Freeze Frame (→ 81)
- In Variable Frame Rate Mode (→ 91)

- **The following menu items are not available when [4:2:2(10bit)] is selected:**

- [VFR MODE] (→ 91, 140)
- [REC MODE] (→ 150)
- [REC FORMAT] (→ 151)
- [SUB REC BUTTON] (→ 167)
- [2 SLOTS FUNC.] (→ 170)
- [DUAL CODEC REC] (→ 172)
- [INTERVAL REC] (→ 173)
- [PRE-REC] (→ 86, 174)
- [TIME STAMP] (→ 175)
- [DOWN CONV.] (→ 180)
- [VIDEO OUT OSD] (→ 116)
- [MEDIA SELECT] (→ 32)
- [MEDIA STATUS] (→ 187)

- The following functions are not available when [4:2:2(10bit)] is selected:
 - [DIGITAL ZOOM] (→ 93)
 - [LAST SCN DEL] (→ 80)
 - [REC CHECK] (→ 80)

Formatting media

If you use the SD cards for the first time for recording with this unit, format the cards. Please be aware that if a medium is formatted, then all the data recorded on the medium will be erased and cannot be restored. Back up important data on a PC etc. (→ 122)

- When using two SD cards, format both SD cards.

1 Select the menu.



2 Touch [SD CARD 1] or [SD CARD 2].

- When formatting is complete, touch [EXIT] to exit the message screen.

- Do not turn this unit off or remove the SD card, while formatting. Do not expose the unit to vibrations or shock.

Use this unit to format media.

Do not format an SD card using any other equipment such as a PC. Otherwise it may not be possible to use the card on this unit.

Recording



Selecting a media to record

[SD CARD 1] and [SD CARD 2] can be selected separately to record motion pictures or still pictures.

- Set [OUTPUT BITS] to [4:2:2(8bit)]. (→ 31)

1 Select the menu.

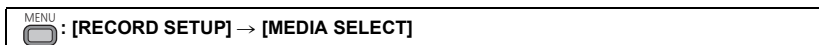

2 Touch the media to record motion pictures or still pictures.

- The media is selected separately for motion pictures or still pictures and is then highlighted in yellow.

3 Touch [EXIT] to complete the setting.



- You can also change the card slot used for motion picture recording by pressing the USER button to which [SLOT SEL] is registered or touching the applicable USER button icon while recording is paused. (→ 75)



Recording motion picture with this unit

- Before turning on this unit, open the lens cover. (→ 12)
- Set [OUTPUT BITS] to [4:2:2(8bit)]. (→ 31)

1 Change the mode to Recording Mode. (→ 23)

- Extract the LCD monitor.

2 Press the recording start/stop button **B** to start recording.

- Recording will stop when you press the recording start/stop button again.

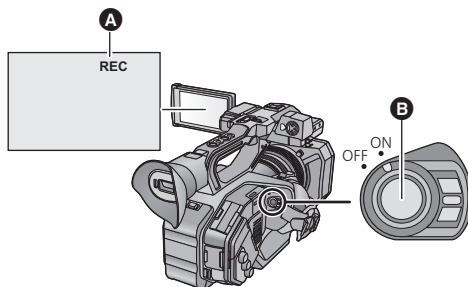

- A** When you begin recording, REC (red) is displayed.

■ Screen indications in the Recording Mode



TC 00:00:00.00	Counter display (→ 71)
1 (White)	Media where the motion picture is recorded (→ 32)
R 1h20m	Approximate remaining recordable time <ul style="list-style-type: none"> • When the remaining time is less than 1 minute, R 0h00m flashes red.
UHD2/160	Recording format (→ 151)
150M	Bit rate (→ 151)
MP4	Recording mode (→ 150)
59.94p	Frame rate (→ 151)

- To change the recording method, change [REC MODE] or [REC FORMAT]. (→ 150, 151)
- The images recorded between pressing the recording start/stop button to start recording and pressing it again to pause recording become one scene.
- When the file size of a recorded scene exceeds one of the following sizes or the recording time exceeds one of the following lengths of time, the scene will be divided automatically. (Recording continues.)
 - AVCHD scene: approximately 4 GB
 - MOV/MP4 scene (when using an SDHC Memory Card): approximately 4 GB or 30 minutes
 - MOV/MP4 scene (when using an SDXC Memory Card): approximately 48 GB or 120 minutes

- (Maximum recordable scenes of a single SD card)

Recording mode	MOV/MP4	AVCHD
Recordable scenes	Approx. 89100	Approx. 3900
Different dates (→ 109)	Approx. 900	Approx. 900

- When the SD card contains scenes recorded with [REC MODE] set to [MOV]/[MP4] and still pictures, the maximum recordable scenes and the maximum recordable scenes on each date will be smaller than those in the table above.
- Number of scenes that can be recorded will be less than above in following cases:
 - If you change [REC FORMAT] (→ 151)
 - When [2 SLOTS FUNC.] is set to [SIMULTANEOUS] or [DUAL CODEC] (→ 170)
 - During the Interval Recording (→ 173)
- Please refer to page 215 about approximate recordable time.

Recording



Recording still pictures

- Before turning on this unit, open the lens cover. (→ 12)
- Set [OUTPUT BITS] to [4:2:2(8bit)]. (→ 31)
- Register [CAPTURE] to a USER button. (→ 75)

1 Change the mode to Recording Mode. (→ 23)



- Extract the LCD monitor.

2 Press the USER button to which [CAPTURE] is registered or touch the applicable USER button icon to record a still picture.

- For information on the locations of the USER buttons and information on USER button icons, refer to page 75.
- When still pictures are being recorded, the remaining recordable number of still pictures and the still picture indication  are displayed.







■ About the screen indications while recording still pictures



 8.3M	Size of still pictures
R3000	Remaining number of still pictures
	Still picture indication (→ 195)

■ About picture size

Picture sizes in which still pictures will be recorded differ depending on the [REC MODE] setting and the [REC FORMAT] setting (→ 150, 151).

Recording mode	Recording format	Aspect	Picture size
MOV, MP4	[REC FORMAT] setting with a size of 4K (4096×2160)	17:9	 4096×2160
	[REC FORMAT] setting with a size of UHD (3840×2160)	16:9	 3840×2160
	[REC FORMAT] setting with a size of FHD (1920×1080)		 1920×1080
AVCHD	[PS 1080/59.94p], [PS 1080/50.00p], [PH 1080/59.94i], [PH 1080/23.98p], [PH 1080/50.00i], [HA 1080/59.94i], [HA 1080/50.00i], [HE 1080/59.94i], [HE 1080/50.00i], [PM 720/59.94p], [PM 720/50.00p],	16:9	 640×360
	[SA 480/59.94i], [SA 576/50.00i]		 640×480
		4:3	 640×480

- **It is possible to record still pictures while recording motion pictures. (rec-and-capture)**
- It is recommended to use a tripod when recording under low light conditions because the shutter speed becomes slow.
- If rec-and-capture is used while recording a motion picture, the remaining recordable time will shorten. If you turn off this unit or press the THUMBNAIL button, the remaining recordable time may become longer.
- Maximum number of recordable pictures that can be displayed is 9999. If the number of recordable pictures exceeds 9999, R 9999+ is displayed. The number will not change when the picture is taken until the number of recordable pictures is 9999 or less.
- When playing back a still picture recorded with this unit in the 17:9 aspect, black bands appear on the top and bottom of the screen.
- The 17:9 or 16:9 still pictures recorded using this unit may be cropped at the edges when printed. So, be sure to check before printing in the store or on your printer.
- Please refer to page 217 about approximate number of recordable pictures.
- The recording time may be long depending on the recording condition.



Switching between Auto and Manual Mode

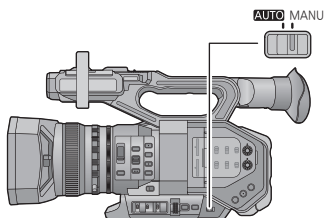

AUTO/MANU switch

Slide the switch to change Auto Mode/Manual Mode.

- **A** is displayed in the Auto Mode.

■ Auto Mode

In Auto Mode, this unit operates according to the [AUTO SW] menu settings.

- When the following settings are automatically adjusted in Auto Mode, the corresponding Manual Mode settings are canceled:
 - Focus (→ 44)
 - Iris (→ 59)
 - GAIN (→ 61)
 - Shutter speed (→ 64)

■ To enable/disable auto switch functions

You can enable/disable functions that are automatically adjusted in Auto Mode.

Select the menu.

MENU : [AUTO SW] → desired setting

Menu item	Setting
[A.IRIS]	<p>[ON]: Activates Auto Iris in Auto Mode.</p> <p>[OFF]: Activates Auto Iris as a manual mode. Use the IRIS button to switch between Auto Iris Mode and Manual Iris Mode.</p>
[AGC]	<p>[ON]: Activates Auto Gain in Auto Mode.</p> <p>[OFF]: Activates Auto Gain as a manual mode. The gain is adjusted according to the settings assigned to the GAIN switch.</p>
[AUTO SHUTTER]	<p>[ON]: Activates Auto Shutter in Auto Mode.</p> <p>[OFF]: Activates Auto Shutter as a manual mode. Press the SHUTTER button to switch between Auto Shutter Mode and Manual Shutter Mode.</p>
[ATW]	<p>[ON]: Activates Auto Tracking White Balance in Auto Mode.</p> <p>[OFF]: Activates Auto Tracking White Balance as a manual mode. The white balance is adjusted according to the setting registered to the WHITE BAL switch.</p>
[AF]	<p>[ON]: Activates Auto Focus in Auto Mode.</p> <p>[OFF]: Activates Auto Focus as a manual mode. Focus is adjusted according to the functions of the FOCUS A/M/∞ switch.</p>

Automatic Tracking White Balance

The Auto Tracking White (ATW) Balance function of this unit automatically adjusts the White Balance according to the lighting condition.

If the Automatic White Balance is not functioning normally, adjust the White Balance manually.

(→ 55)

Auto Focus

The unit focuses automatically.

- Auto Focus does not work correctly in the following situations. Record pictures in the Manual Focus Mode. (→ 44)
 - Recording distant and close-up objects at the same time
 - Recording a subject behind dirty or dusty window
 - Recording a subject that is surrounded by objects with glossy surfaces or by highly reflective objects

■ Controls that are disabled in Auto Mode

Certain controls of this unit may be disabled in Auto Mode. Controls to be disabled vary by the [AUTO SW] menu settings.

Conditions that disable controls	Controls that are disabled in Auto Mode
[A.IRIS] is set to [ON].	Iris Ring, IRIS button
[AGC] is set to [ON].	GAIN switch, the USER button to which [SUPER GAIN] is registered
[AUTO SHUTTER] is set to [ON].	SHUTTER button
[ATW] is set to [ON].	WHITE BAL switch
[AF] is set to [ON].	Focus ring, FOCUS ASSIST button, FOCUS A/M/∞ switch, PUSH AUTO button, the USER button to which [FOCUS ASSIST 1], [FOCUS ASSIST 2], [PUSH AUTO] or [FOCUS TRANSITION] is registered

Recording



Adjusting the Picture Quality

You can set the picture quality of images to be recorded in the main menu → [SCENE FILE].

Detail function

This function thickens or weakens the outlines of images. It effectively softens or sharpens images, but in some cases, the whole image may become rough due to emphasized noise and edges. To avoid such problems, it is necessary not to add this effect on parts where emphasizing is not needed and keep the details of the parts.

■ Menu item

- [MASTER DETAIL]: Adjusts the degree of overall outline correction in images. (→ 141)
[DETAIL CORING]: Adjusts the detail noise removal level. (→ 142)
[SKIN TONE DTL]: Makes skin colors appear softer for a more attractive appearance. (→ 142)
[V DETAIL LEVEL]: Adjusts the degree of vertical outline correction in images. (→ 142)
[KNEE APE LEVEL]: Sets the detail level of high luminosity areas (extremely bright areas). (→ 143)

Skin tone function

This function makes human skin look smoother in images.

■ Menu item

- [SKIN TONE DTL] (→ 142)

RB gain control function

This function makes settings to add or reduce intensity of red and blue colors according to the position of the WHITE BAL switch. The function works when the switch is at the [PRST] position or when Automatic White Balance is enabled. It does not work with Auto Tracking White Balance.

■ Menu item

[RB GAIN CONTROL SETTING] (→ 143)

Chroma setting function

This function sets color saturation and phase. It applies effects on whole images. It cannot be set to individual color hue.

■ Menu item

[CHROMA LEVEL]: Adjusts the color density. (→ 144)

[CHROMA PHASE]: Adjusts the color balance. (→ 144)

Color correction function

This function sets color saturation and phase. It applies individual effect on 16 phases in an image. It can be set to individual color hue.

■ Menu item

[COLOR CORRECTION SETTING] (→ 145)

Black control function

This function sets the black level that is to be the reference of luminance.

■ Menu item

[MASTER PED] (→ 146)

Gamma function

This function optimizes the tone of images.

■ Menu item

[GAMMA MODE]: Sets the optimal tone and contrast of images for the scene to be recorded. (→ 146)

[BLACK GAMMA]: Sets the gamma curve for dark areas. (→ 147)

[BLACK GAMMA RANGE]: Sets the upper limit on the compression/expansion of the [BLACK GAMMA] setting. (→ 147)

Knee function

This function sets the compression of video signals to prevent white saturation in images.

■ Menu item

[KNEE MODE]: Sets the compression level of highly bright image signals received by the image sensor to minimize white saturation. (→ 147)

[KNEE MASTER POINT]: Adjusts the knee point position in 0.5% steps. (→ 147)

[KNEE MASTER SLOPE]: Sets the knee inclination. (→ 148)



Using the zoom

It can be zoomed up to 13×.

- (When the picture size of [REC FORMAT] (→ 151) or [OUTPUT FORMAT] (→ 157) is 1920×1080 or below)
It can zoom up to approx. 20× when the [i.Zoom] is set to [ON]. (→ 168)
- You can change the unit of the on-screen zoom magnification display by changing the [ZOOM/ FOCUS] setting in the [DISP SETUP] menu. You can also change the setting so that the on-screen display does not appear. (→ 184)
- When [FOCUS MACRO] is set to [OFF], subjects at a distance of approximately 1.0 m (3.3 feet) to infinity can be brought into focus. When [FOCUS MACRO] is set to [ON] and the zoom position is at the W end, subjects at a distance of approximately 10 cm (3.93 ") to infinity can be brought into focus. (→ 78, 165)

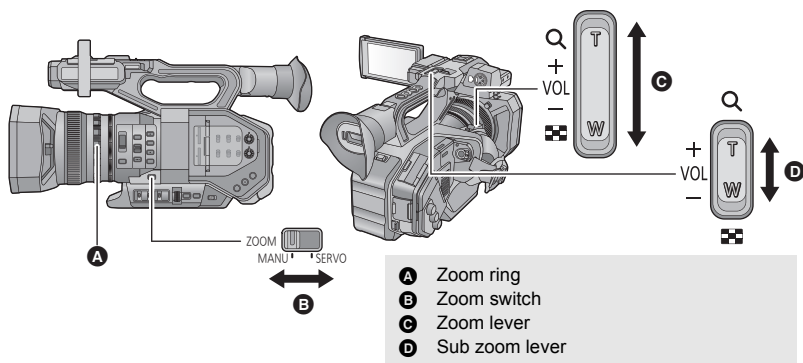

1 Slide the ZOOM switch.

MANU: Zoom operation can be done using the zoom ring.

SERVO: Zoom operation can be done using the zoom lever/sub zoom lever.

2 (Set the ZOOM switch to [MANU])

Operate the zoom ring.

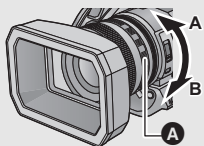

Zoom ring **A**

A side:

Wide-angle recording (zoom out)

B side:

Close-up recording (zoom in)

(Set the ZOOM switch to [SERVO])

Operate the zoom lever/sub zoom lever.

T side: Close-up recording (zoom in)

W side: Wide-angle recording (zoom out)

- If you take your finger off the zoom lever during zoom operation, the operation sound may be recorded. When returning the zoom lever to the original position, move it quietly.

Adjusting the i.Zoom magnification

When [i.Zoom] is set to [ON], you can zoom in while maintaining the beauty of high-definition picture quality up to a magnification of approx. 20 \times .

- Set [REC FORMAT] or [OUTPUT FORMAT] to a setting with a picture size of 1920 \times 1080 or below. (→ 151, 157)

1 Select the menu.

 : [SW SETUP] → [i.Zoom] → [ON]

- The zoom magnification display will change.

(Example)

iZ99 1.00



- A Zoom magnification
- B i.Zoom magnification*

- C i.Zoom button icons
- D Zoom magnification



* You can select a value between 1.00 and 1.54.

- If you touch the screen, i.Zoom button icons are displayed.

2 Touch the i.Zoom button icons (/) to change the i.Zoom magnification.

- You can use i.Zoom by registering [i.Zoom] to a USER button. (→ 75)
- This function is not available in the following cases:
 - In Variable Frame Rate Mode (→ 91)
 - When [REC FORMAT] or [OUTPUT FORMAT] is set to a setting with a size of 4K (4096 \times 2160) or UHD (3840 \times 2160)
 - During Freeze Frame (→ 81)
- [i.Zoom] is canceled in the following cases.
 - If you turn the unit off
 - If you press the THUMBNAIL button
 - When [USB MODE SELECT] is set to [DEVICE] and this unit is connected to a PC. (→ 123)

Using Fast Zoom

When [FAST ZOOM] is set to [ON], you can use Fast Zoom while operating the zoom with the zoom lever.

1 Select the menu.

 : [SW SETUP] → [FAST ZOOM] → [ON]

2 Push the zoom lever fully to operate the zoom.

- The zoom magnification display changes when using Fast Zoom. (Example: )

■ About the zoom speed

- The zoom speed will vary depending on how far the zoom lever is pressed or how fast the zoom ring is rotated.
- The zoom operation using the sub zoom lever will be performed at a constant speed. Zoom speed of the sub zoom lever will vary depending on the setting of [SUB ZOOM]. (→ 167)

- You can also use Fast Zoom by registering [FAST ZOOM] to a USER button. (→ 75)
- The sound of the zoom mechanism becomes louder than usual during fast zoom operation. This may cause the sound to be recorded during recording.

Utilizing the USER button

Digital zoom can be used by setting the USER button. (→ 93)

- Please refer to page 75 for details about setting the USER button.

Recording



Image Stabilizer Function

Use the Image Stabilizer to reduce the effects of shake during recording.

This unit is equipped with Hybrid Optical Image Stabilizer.

Hybrid Optical Image Stabilizer is a hybrid of Optical and Electrical Image Stabilizer.

1 Register "O.I.S." to a USER button. (→ 75)

- This function is registered to the USER5 button by default.

2 Press the USER button to which [O.I.S.] is registered or touch the applicable USER button icon to switch the Image Stabilizer on/off.

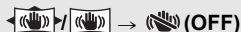

- You can also access this function by selecting menu items.

[SW SETUP] → [O.I.S.] → [ON]/[OFF]

- When [HYBRID O.I.S.] is [ON], is displayed. When [OFF], is displayed.
- This item cannot be set during Freeze Frame (→ 81)

■ Changing Image Stabilizer Mode

Select the menu.

MENU
 : [SW SETUP] → [HYBRID O.I.S.] → [ON] or [OFF]

When set to [ON], you can further improve image stabilization for holding the unit and recording a distant subject with zoom.

- Optical Image Stabilizer will be disabled and the setting cannot be changed in the following cases:
 - When Optical Image Stabilizer is set to (setting canceled)
 - When the size is set to 4K (4096×2160) or UHD (3840×2160) in [REC FORMAT] or [OUTPUT FORMAT] (→ 151, 157)
 - During Freeze Frame (→ 81)
 - In Variable Frame Rate Mode (→ 91)

- Stabilization may not be possible under strong shaking conditions.
- When using a tripod, we recommend that you set the Image Stabilizer to  (setting canceled).

Customizing the Image Stabilizer for various recording conditions

You can customize the Image Stabilizer by adjusting the [BLUR AMPLITUDE] and [BLUR FREQUENCY] settings individually.

■ Custom Optical Image Stabilizer

When [ON] is selected, the Image Stabilizer works with customized [BLUR AMPLITUDE] and [BLUR FREQUENCY] settings.

Select the menu.

 : [SW SETUP] → [CUSTOM O.I.S.] → [ON]

■ Blur amplitude

You can adjust the performance of camera shake correction according to the level of camera shake during recording.

Select the menu.

 : [SW SETUP] → [BLUR AMPLITUDE] → desired setting

[1]/[2]/[3]/[4]/[5]

- If you set a smaller value, correction performance against minor camera shake will be enhanced. Even though smaller values allow more effective screen stabilization in situations with minor camera shake, such as when you are recording from a fixed position, they are less effective for correcting significant camera shake. We recommend setting a smaller value when you keep recording the same subject, for example.
- If you set a larger value, camera shake of varying degrees ranging from minor to significant will be corrected in a balanced manner. Although larger values allow you to correct significant camera shake more effectively, the screen becomes unstable when you are recording from a fixed position. We recommend that you set a larger value in situations where images are expected to be quite blurry, such as when recording in an unstable position.

■ Blur frequency

You can change the target frequency range for camera shake correction to adjust its performance according to the recording style.

Select the menu.

 : [SW SETUP] → [BLUR FREQUENCY] → desired setting

- [1]: This enhances the correction performance against camera shake of varying degrees, ranging from slow camera shake that falls in the low frequency range to fast and subtle camera shake that falls in the high frequency range. We recommend that you select this setting when recording a subject from a fixed position without panning or tilting this unit.
- [2]: This is a standard setting which enhances the correction performance against camera shake that falls in the average-to-high frequency range. Even while adjusting the position of this unit, you can keep the resulting motion in the image look natural and maintain the correction performance.

[3]: This mainly enhances the correction performance against fast and subtle camera shake that falls in the high frequency range while weakening the correction performance against slow camera shake that falls in the low frequency range. We recommend that you use this setting when panning or tilting this unit many times while recording.

Recording



FOCUS

Perform focus adjustments using the focus ring. If auto focusing is difficult due to the conditions, then use Manual Focus.

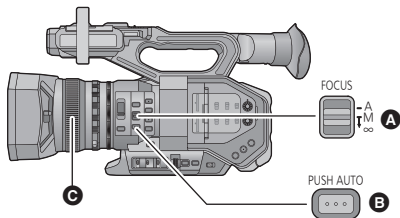

- A FOCUS A/M/∞ switch
- B PUSH AUTO button
- C Focus ring

- Switch to Manual Mode. (→ 36)

1 Set the FOCUS A/M/∞ switch to [M] to enable Manual Focus.

- It will switch to MF from AF.

2 Adjust the focus by rotating the focus ring.

- The focus value can be set from MF00 (focus distance: approximately 10.0 cm (3.93 ") [When [FOCUS MACRO] (→ 78, 165) is set to [ON]]) to MF99 (focus distance: infinity). The larger the focus value gets, the further the position where focus is achieved.
 - If you move the FOCUS A/M/∞ switch towards [∞], focus will be adjusted to MF95 on the infinity side. (The FOCUS A/M/∞ switch will return to the [M] position.)
 - To return to Auto Focus, set the FOCUS A/M/∞ switch to [A], or set [AF] to [ON] and switch to Auto Mode. (→ 36)
-
- If you set [FOCUS MACRO] to [ON], when the distance to the subject approaches within 0.8 m (2.6 feet) approx., the unit switches to the macro range and [AF] or [MF]. (The unit may switch to the macro range even when the distance to the subject is 0.8 m (2.6 feet) or more depending on the subject.)
 - Depending on the zoom magnification, this unit may fail to switch to the macro range, or go to a non-displayed focus value.
 - When you perform a zoom operation in the macro range, this unit may go out of focus.
 - When [AF] is set to [ON] and this unit is set to Auto Mode, auto focusing is performed regardless of the position of FOCUS A/M/∞ switch. (→ 36)
 - When a remote control (commercially-available) is connected, even if you move the FOCUS A/M/∞ switch towards [∞], focus cannot be adjusted to MF95. (→ 114)
 - The unit of the focus value display varies depending on the [ZOOM/FOCUS] setting in the [DISP SETUP] menu. You can also change the setting so that the on-screen display does not appear. (→ 184)

■ To change the way you adjust focus with the focus ring

Select the menu.

 : [SW SETUP] → [FOCUS RING DRIVE]

[SPEED]:	Adjusts the focus value according to the speed at which the focus ring is rotated.
[COARSE]:	Adjusts the focus value according to the rotational position of the focus ring. Since the operation of the focus ring results in a greater change in focus value, this setting is suitable for making rough adjustments.
[FINE]:	Adjusts the focus value according to the rotational position of the focus ring. Since the operation of the focus ring results in a smaller change in focus value, this setting is suitable for making fine adjustments.

■ To emphasize the outline of images

Setting [EVF/LCD DETAIL] to [ON] helps you achieve focus easier by emphasizing the outlines of an image displayed on the LCD monitor and viewfinder.

You can also adjust the emphasis level or change the frequency.

- You can also enable or disable this function with the applicable USER button. (→ 83)
- These settings will not affect the images actually recorded.

 : [DISP SETUP] → [EVF/LCD DETAIL] → [ON]

Adjusting the level of [EVF/LCD DETAIL]

1 Select the menu.

 : [DISP SETUP] → [EVF/LCD PEAK LEVEL]

2 Touch  /  to adjust settings.

- You can select a value between -3 and +3.

3 Touch [EXIT] to complete the setting.

Setting the peaking frequency of [EVF/LCD DETAIL]

Select the menu.

 : [DISP SETUP] → [EVF/LCD PEAK FREQ.] → [HIGH] or [LOW]

-
- [EVF/LCD DETAIL] is canceled in following cases:
 - If you use Focus Assist (→ 48)

Customizing Auto Focus for various recording conditions

You can customize Auto Focus for various recording conditions by adjusting the settings of [AF SPEED], [AF SENSITIVITY], and [AF AREA WIDTH] individually.

■ Custom AF function

When [ON] is selected, Auto Focus works with customized [AF SPEED] and [AF SENSITIVITY] settings.

- Switch to Auto Focus Mode. (→ 44)

Select the menu.

 : [SW SETUP] → [CUSTOM AF] → [ON]

■ AF speed setup

You can change the focus speed of Auto Focus.

- Switch to Auto Focus Mode. (→ 44)
- Set [CUSTOM AF] to [ON].

1 Select the menu.

 : [SW SETUP] → [AF SPEED]

2 Touch  /  to adjust settings.

- You can select a value between -5 and +5.
- The larger the value is, the faster the focus speed will become. Conversely, the smaller the value is, the slower the focus speed will become.

3 Touch [EXIT] to complete the setting.

■ AF Sensitivity setup

You can enhance the stability or tracking performance of Auto Focus.

- Switch to Auto Focus Mode. (→ 44)
- Set [CUSTOM AF] to [ON].

1 Select the menu.

 : [SW SETUP] → [AF SENSITIVITY]

2 Touch  /  to adjust settings.

- You can select a value between 0 and 10.
- Setting a larger value will enhance the tracking performance of focus, making it easier to move focus between subjects at varying distances from this unit. We recommend that you set a larger value to keep focus on a fast-moving subject.
- Setting a smaller value will provide more stability to focus, making it easier to keep focus on the targeted subject even when an intervening object passes in front of the camera or the subject disappears from the view of this unit. We recommend that you set a smaller value to avoid bringing an intervening object or the background into focus.

3 Touch [EXIT] to complete the setting.

-
- [CUSTOM AF], [AF SPEED] and [AF SENSITIVITY] cannot be set in Variable Frame Rate Mode. (→ 91)
 - [AF SPEED] and [AF SENSITIVITY] cannot be set in Manual Focus Mode.
 - When a faster [AF SPEED] value is selected, focus mechanism noise will be more audible. As a result, the noise may be recorded while recording is in progress.

■ AF Area Range Adjustment

You can adjust the effective area width for Auto Focus according to the size of the subject.

- **Switch to Auto Focus Mode.** (→ 44)

1 Select the menu.

MENU : [SW SETUP] → [AF AREA WIDTH] → [SET]

2 Push the jog dial.



3 Rotate the jog dial to adjust the AF area frame.

- Ⓐ [RETURN]
- Ⓑ AF area frame
- Ⓒ [EXIT]

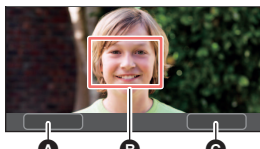

4 Touch [EXIT] to complete the setting.

- [AF-AREA] will be displayed on the screen.

-
- To cancel the settings, set [AF AREA WIDTH] to [OFF].
 - If you push the jog dial in Step 2, the AF area frame turns yellow, allowing you to select [RETURN]/[EXIT] by rotating the jog dial. Push the jog dial to set the selected item.
 - You can also adjust AF area width by registering [AF AREA WIDTH] to a USER button. (→ 90)
 - This function is not available in the following cases:
 - In manual focus mode (→ 44)
 - When using Area Mode (→ 82)
 - During Freeze Frame (→ 81)

One Push AF

If you press the PUSH AUTO button in Manual Focus Mode, the camera performs high-speed focusing until the image is focused.

- **Switch to Manual Focus Mode.** (→ 44)

Press PUSH AUTO button.

- Auto Focus will be activated and the camera will perform high-speed focusing until the image is focused.
- The focus setting returns to Manual Focus Mode once the image is focused or a certain time has elapsed.

-
- You can also use One Push AF with the USER button to which [PUSH AUTO] is registered. (→ 75)

Push AF

If you press and hold the PUSH AUTO button, Manual Focus will be temporarily switched to Auto Focus.

- **Set this unit to Manual Focus.** (→ 44)

Press and hold the PUSH AUTO button.

- The focus position will be automatically adjusted for the subject at the center of the screen.
- If you set [AREA MODE] to [FOCUS], [FOCUS/IRIS] or [FOCUS/Y GET] and use Area Mode, the focus position will be automatically adjusted to the subject you have touched. (→ 82)
- It will be canceled when the button is released, and the focus position set by the Push AF will be maintained.

-
- You can also use Push AF with the USER button to which [PUSH AUTO] is registered. (→ 75)
 - Push AF does not work in following cases:
 - When Auto Focus is used
 - When a remote control (commercially-available) is connected (→ 114)

Focus Assist

You can use Focus Assist by pressing the FOCUS ASSIST button or the USER button to which [FOCUS ASSIST 1] or [FOCUS ASSIST 2] is registered.

- For information on how to set the USER buttons, refer to page 75.

Selecting a Focus Assist method

- **To select the Focus Assist method for the FOCUS ASSIST button or the USER button to which [FOCUS ASSIST 1] is registered**

Select the menu.

 : [SW SETUP] → [FOCUS ASSIST 1] → desired setting

[EXPAND]:	Magnifies the central area of the screen when Focus Assist is used.
[PEAKING]:	Highlights in-focus portions with color when Focus Assist is used.
[BOTH]:	Sets both [EXPAND] and [PEAKING].

- **To select the Focus Assist method for the USER button to which [FOCUS ASSIST 2] is registered**

Select the menu.

 : [SW SETUP] → [FOCUS ASSIST 2] → desired setting

[EXPAND] / [PEAKING]

- You can use the magnified display and the peaking function separately or use them in combination by selecting different settings for [FOCUS ASSIST 1] and [FOCUS ASSIST 2].
- If [FOCUS ASSIST 1] is set to [BOTH], [FOCUS ASSIST 2] is not available. In addition, the USER button to which [FOCUS ASSIST 2] is registered is disabled.

Using Focus Assist

- Switch to Manual Focus Mode. (→ 44)

Press the **FOCUS ASSIST** button or the **USER** button to which **[FOCUS ASSIST 1]** or **[FOCUS ASSIST 2]** is registered.

- You can also use Focus Assist by touching the **USER** button icon to which **[FOCUS ASSIST 1]** or **[FOCUS ASSIST 2]** is registered.
- To turn off Focus Assist, perform the following operations:
 - Press the **FOCUS ASSIST** button or the **USER** button again, or touch the **USER** button icon again.
 - Touch **[EXIT]**.

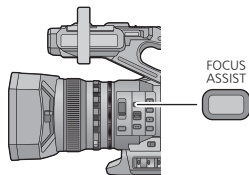

■ To adjust the magnified display

If you set Focus Assist to ON by following either of the procedures below, the central area of the screen will be magnified. You can change the magnification and position of the magnified display.

- Setting the menu item **[FOCUS ASSIST 1]** to **[EXPAND]** or **[BOTH]** and pressing the **FOCUS ASSIST** button or the **USER** button to which **[FOCUS ASSIST 1]** is registered.
- Setting the menu item **[FOCUS ASSIST 2]** to **[EXPAND]** and pressing the **USER** button to which **[FOCUS ASSIST 2]** is registered.
- You can also change the magnification level of the magnified display using the jog dial.

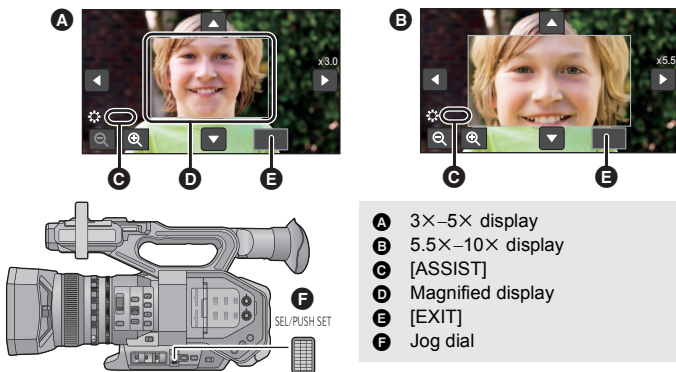

(To change the magnification level)

Touch **+** / **-** or rotate the jog dial to change the magnification level.



+ : Increases the magnification level by 0.5×.

- : Decreases the magnification level by 0.5×.

- You can adjust the magnification from 3× to 10×.

(Moving the magnified area)

Touch **▲** / **▼** / **◀** / **▶** or slide the screen while touching it to move the magnified area.

■ To change the peaking settings

If you set Focus Assist to ON by following either of the procedures below, in-focus portions are highlighted with color (peaking).

- Setting the menu item [FOCUS ASSIST 1] to [PEAKING] or [BOTH] and pressing the FOCUS ASSIST button or the USER button to which [FOCUS ASSIST 1] is registered.
- Setting the menu item [FOCUS ASSIST 2] to [PEAKING] and pressing the USER button to which [FOCUS ASSIST 2] is registered.

F Peaking

- You can set the peaking color and strength.

(When changing the peaking color)

Select the menu.

 : [SW SETUP] → [PEAKING COLOR] → desired color

[Red]/[Blue]/[Yellow]/[White]

(When setting the peaking strength)

1 Select the menu.

 : [SW SETUP] → [PEAKING LEVEL] → desired setting

2 Touch / to adjust settings.

- You can select a value between -7 and +7.

3 Touch [EXIT] to complete the setting.

(Notes on Focus Assist)

- Focus Assist is not possible in following cases:
 - During Recording Check (→ 80)
 - During Freeze Frame (→ 81)
 - When color bars are displayed. (→ 96)
- Focus Assist is canceled in following cases:
 - If you turn the unit off
 - If you press the THUMBNAIL button
 - (If you operate the FOCUS ASSIST button or the USER button to which [FOCUS ASSIST 1] is registered)
 - When the setting of [FOCUS ASSIST 1] (→ 49) is changed
 - (If you operate the USER button to which [FOCUS ASSIST 2] is registered)
 - When the setting of [FOCUS ASSIST 2] (→ 49) is changed
 - When EVF/LCD detail is enabled. (→ 45)
 - When you set this unit to Auto Focus
 - When you press the USER button to which [FOCUS TRANSITION] is registered or touch the applicable USER button icon (→ 53)
 - When [USB MODE SELECT] is set to [DEVICE] and this unit is connected to a PC. (→ 123)
- The magnified display and peaking are not displayed on recorded images.
- The magnified display and peaking are not displayed on an external monitor.
- Freeze Frame is not available when you use Focus Assist. (→ 81)



F

- Peaking may not be displayed when you use Digital Zoom (→ 93). To zoom in and use peaking at the same time, we recommend increasing the magnification level of the magnified display by setting [FOCUS ASSIST 1] to [BOTH] or by using the magnified display and the peaking function in combination.

(Notes on the magnified display of Focus Assist)

- Some information on the screen disappears when the screen is magnified.
- Still pictures cannot be recorded when the screen is magnified.
- In the following cases, the screen is not magnified during Focus Assist:
 - During motion picture recording or PRE-REC (→ 86, 174)
 - When using Digital Zoom
 - When using Area Mode (→ 82)
 - During auto recording (→ 90)
 - In Variable Frame Rate Mode (→ 91)
 - During AG ROP application connection (→ 131)
- If you set the magnification level of the magnified display to 5.5× or higher, peaking may not be displayed when using i.Zoom (→ 41).

Manual Focus Assist

Focus is automatically adjusted after you adjust it with the focus ring in Manual Focus Mode.

- Focus may not be achieved when the focus deviation is great.
- After automatic adjustment is complete, the focus is not adjusted automatically again until you operate the focus ring.
- **Switch to Manual Focus Mode.** (→ 44)

1 Select the menu.

 : [SW SETUP] → [MF ASSIST] → [ON]

- Touch [EXIT] to complete the setting.
- The on-screen icon changes from [MF] to [MA].

2 Adjust the focus by rotating the focus ring.

- Focus is automatically adjusted after you adjust it with the focus ring.
- The color of the on-screen icon for the focus value changes during automatic adjustment.

-
- This function is not available in the following cases:
 - When Auto Focus is used
 - When using Area Mode (→ 82)
 - In Variable Frame Rate Mode (→ 91)
 - The on-screen icon changes to  in the macro range.
 - Manual focus assist does not work in following cases:
 - When adjusting the focus with the remote control (commercially-available) (→ 114)

■ To change the Manual Focus Assist setting

You can change the way focus is adjusted when Manual Focus Assist is used.

- **Switch to Manual Focus Mode.** (→ 44)

Select the menu.

 : [SW SETUP] → [MF ASSIST MODE] → desired setting

[CENTER AREA]:	Fine-adjusts focus for the subject at the center of the screen.
[MULTI AREA]:	Adjusts focus for the subject closest to the current focus position.

- Touch [EXIT] to complete the setting.
-
- [MF ASSIST MODE] cannot be set in Auto Focus Mode.
 - It may be easier to see a change in focus when [MULTI AREA] is selected.
We recommend that you adjust focus before recording.
 - Focus may not be achieved depending on the recording condition such as brightness or contrast, even if [MULTI AREA] is selected.
 - If focus is not achieved within a certain period of time, focus returns to the position before the automatic adjustment.

Focus Transition

You can use Focus Transition by registering "Focus Transition" to a USER button. With Focus Transition, you can shift the current focus position to a pre-registered focus position.

- Please refer to page 75 for details about setting the USER button.

Registering a focus position

To use Focus Transition, you need to register a focus position.

- You can register up to 3 focus positions.
- **Switch to Manual Focus Mode.** (→ 44)

1 Select the menu.

 : [RECORD SETUP] → [FOCUS TRANSITION] → [SET]

2 Touch the item to which you want to register the focus position.

[1]/[2]/[3]

- You can select the item by pressing the USER buttons 1-3.
- The Focus Assist screen will be displayed.
- The screen may not be magnified depending on your settings.

3 Adjust the focus by rotating the focus ring.

4 Touch [ENTER].

- The icon of the item to which the focus position has been registered will be highlighted in yellow.
- To select a different item, perform the operations in Steps 2–4.

5 Touch [EXIT] to complete the setting.

- The focus positions of the items you have set will be registered.

- This function is not available in the following cases:
 - When Auto Focus is used
 - During Freeze Frame (→ 81)
 - In Variable Frame Rate Mode (→ 91)
- The focus position settings are canceled in the following cases:
 - If you turn the unit off
 - If you press the THUMBNAIL button
 - If you operate the zoom

Using Focus Transition

- Select the [FOCUS TRANSITION] menu. (→ 52)
- Register [FOCUS TRANS] to a USER button. (→ 75)

1 Switch to Manual Focus Mode. (→ 44)

2 Press the USER button to which [FOCUS TRANSITION] is registered or touch the applicable USER button icon.

3 Touch a registered item ([1]–[3]).

- Focus Transition will start. Focus will shift slowly from the current position to the registered position. This will take a few seconds. (→ 54)
- As the focus shifts, the Focus Transition bar will move from [S] to [E].

4 Touch [EXIT] to exit Focus Transition.

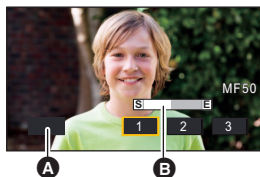

- A** [EXIT]
- B** Focus Transition bar

- If you move this unit a lot after setting the focus position, focus may not stop at the set position.
- When Focus Transition is in use, focus cannot be adjusted with the focus ring.
- Focus Transition is not available in the following cases:
 - When Auto Focus is used
 - During Freeze Frame (→ 81)
 - In Variable Frame Rate Mode (→ 91)
 - When color bars are displayed. (→ 96)
 - When a remote control (commercially-available) is connected (→ 114)
 - During AG ROP application connection (→ 131)
- Focus Transition settings are canceled in the following cases. To use Focus Transition again, register a focus position again. (→ 52)
 - If you operate the zoom
 - If you enable or disable Infrared Recording Mode

- When Focus Transition is in use, only the USER button functions below are available. Press the applicable USER button (one of the USER buttons 5 to 8 or the AWB button) to use them. (→ 75)
 - [FOCUS ASSIST 1]
 - [FOCUS ASSIST 2]
 - [FOCUS TRANSITION]
 - [INFRARED REC]
 - [BACKGROUND]
 - [PRE-REC]
 - [USB MODE]
 - [EVF ON/OFF]
 - [AUTO REC]
 - [MENU]
- You can switch between the items or exit Focus Transition by pressing the USER buttons 1–4.

USER button	Corresponding setting
USER1 to USER3	[1] to [3]
USER4	[EXIT]

- When using Focus Transition, functions registered to the USER buttons 1–4 do not work with the USER buttons.

To set the Focus Transition time

1 Select the menu.

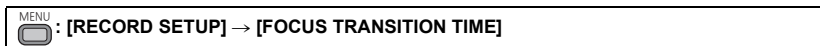

2 Touch the desired setting item.

[DIRECT]/[FASTEST]/[2-15 SEC.]/[20 SEC.]/[30 SEC.]/[45 SEC.]/[60 SEC.]/[90 SEC.]

- If you select [DIRECT], the focus position changes as soon as Focus Transition starts, but the operating noise of the lens may be recorded.

3 (If you have selected [2-15 SEC.] in Step 2)

Touch ▲/▼ to set the duration.

- You can set a Focus Transition time of 2–15 seconds (by 0.5 second increments).
- Touch [RETURN].

4 Touch [EXIT] to complete the setting.

To start Focus Transition and recording simultaneously

You can start Focus Transition and recording simultaneously by enabling [FOCUS TRANSITION REC].

1 Select the menu.

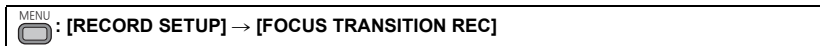

2 Touch the item.

[1]/[2]/[3]

3 Touch [EXIT] to complete the setting.

4 When the recording screen is displayed, press the USER button to which [FOCUS TRANSITION] is registered or touch the applicable USER button icon.

5 Press the recording start/stop button or the USER button to which [AUTO REC] is registered.

- Recording and Focus Transition will start simultaneously. Focus will shift to the position you have set in Step 2.

To set the length of time before Focus Transition starts

Select the menu.

MENU : [RECORD SETUP] → [FOCUS TRANSITION WAIT] → desired time

[0 SEC.]/[5 SEC.]/[10 SEC.]

Recording



White Balance

Automatic White Balance function may not reproduce natural colors depending on the scenes or lighting conditions. If so, you can adjust the White Balance manually.

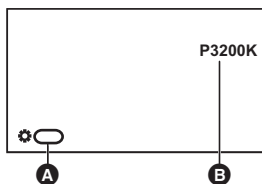

- A** [WB]
- B** White Balance
- 1** Jog dial
- 2** WHITE BAL switch

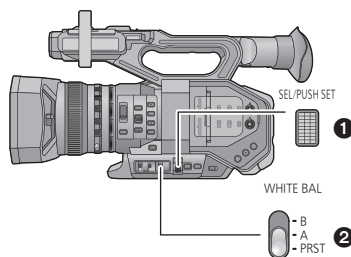

- Register [AWB] (Auto White Balance) to a USER button. (→ 75)
- Switch to Manual Mode. (→ 36)

1 Set the WHITE BAL switch to PRST.

- The White Balance mode set in [WB PRESET] will be displayed.
- If it will switch to A or B, the White Balance mode is set to [Ach] or [Bch].

2 Press the USER button to which [AWB] is registered or touch the applicable USER button icon to change the White Balance mode.

- The mode will change each time you press the USER button to which [AWB] is registered or touch the applicable USER button icon.
[P3200K] → [P5600K] → [VAR]
 - It is not possible to change the White Balance mode without registering [AWB] to a USER button.
-
- If you set the White Balance mode to [ATW] in by following either of the procedures below, the White Balance mode cannot be changed even if you press the USER button to which [AWB] is registered or touch the applicable USER button icon.
 - Pressing the USER button to which [ATW] is registered (→ 75, 79)
 - Setting the WHITE BAL switch to the position corresponding to your [ATW SET] setting (→ 163)

About White Balance modes

Mode	Settings
ATW (ATW)^{*1}	It will automatically adjust in accordance with the recording condition.
LOCK (ATW Lock)^{*2}	It will lock the setting for ATW. (→ 57)
P3200K (P3200K)	Preset value for studio/indoor recording (halogen lamp, etc.)
P5600K (P5600K)	Preset value for outdoors
VAR (VAR)	Setting can be finely adjusted in accordance to the recording conditions. (→ 58)
Ach (Ach)	Setting can be optimized for the scene to be recorded when you set the WHITE BAL switch to [A]. (→ 58)
Bch (Bch)	Setting can be optimized for the scene to be recorded when you set the WHITE BAL switch to [B]. (→ 58)

*1 This setting is selected automatically when one of the following operations is performed:

- Set [ATW] to [ON] and switch to Auto Mode. (→ 36)
- Press the USER button to which [ATW] is registered. (→ 75, 79)
- Set the WHITE BAL switch to the position corresponding to your [ATW SET] (→ 163) setting.

*2 You can set this mode with a USER button.

- In the following cases, even if you press the USER button to which [ATW] is registered or change the position of the WHITE BAL switch, the White Balance mode cannot be changed:
 - In Auto Mode with [ATW] set to [ON]
 - During Freeze Frame (→ 81)
- [RB GAIN CONTROL SETTING] allows you to fine-adjust the color balance for each position of the WHITE BAL switch. (→ 143)

Customizing ATW for various recording conditions

You can customize the ATW settings for various recording conditions by adjusting the settings of [ATW SPEED], [ATW TARGET R], and [ATW TARGET B] individually.

■ Adjusting the control speed of ATW

Select the menu.

 : [SW SETUP] → [ATW SPEED] → desired setting

[FAST]/[NORMAL]/[SLOW]

■ Fine-adjusting the color balance of ATW

1 Select the menu.

 : [SW SETUP] → [ATW TARGET R] or [ATW TARGET B]

- [ATW TARGET R] adjusts the intensity of red.
- [ATW TARGET B] adjusts the intensity of blue.

2 Touch  /  to adjust settings.

- You can select a value between -10 and +10.

3 Touch [EXIT] to complete the setting.

To set ATW Lock

You can set ATW Lock by registering [ATW LOCK] to a USER button.

- Please refer to page 75 for details about setting the USER button.

1 Set the White Balance mode to [ATW].

2 Press the USER button to which [ATW LOCK] is registered or touch the applicable USER button icon.

- To cancel ATW Lock, press the USER button or touch the USER button icon again. Canceling ATW Lock will return the White Balance mode back to [ATW].

-
- This function is not available in the following cases:

- When the White Balance mode is set to something other than [ATW]

- It will be canceled when the unit is turned off.

To finely adjust the White Balance

Setting the White Balance mode to [VAR] allows you to set a White Balance value between 2000K and 15000K.

- Use the jog dial to change the settings.
- **Switch to Manual Mode.** (→ 36)

- 1 Set the White Balance mode to [VAR].** (→ 55)
- 2 Rotate the jog dial to adjust the color balance.**



- 3 Push the jog dial to finish the adjustment.**



-
- You can also access this setting by selecting menu items.
[SW SETUP] → [WB VAR] (→ 163)

To set the White Balance in accordance to the recording scene

- **Register [AWB] (Auto White Balance) to a USER button.** (→ 75)

- 1 Fill the screen with a white subject or place a white piece of paper in front of the lens.**

- 2 Set the WHITE BAL switch to A or B.**

- The White Balance mode will be set to [Ach] or [Bch].

- 3 Press the USER button to which [AWB] is registered or touch the applicable USER button icon to set the Auto White Balance mode.**

- Adjust the Black Balance first, and then the White Balance. The screen goes dark momentarily, "WB SET OK" is displayed, and the adjustment ends.
- If you have pressed the USER button to which [AWB] is registered or touched the applicable USER button icon, only the White Balance is adjusted. When "WB SET OK" is displayed, the adjustment is complete.

-
- When the White Balance mode is set to a setting other than [Ach] or [Bch], if you press and hold the USER button to which [AWB] is registered or touch and hold the applicable USER button icon while recording is paused, Auto Black Balance will operate. Setting is completed when the screen goes black momentarily and "BB SET OK" is displayed.
 - When the Auto White Balance/Auto Black Balance cannot be performed, an error message "WB SET NG" or "BB SET NG" is displayed on the screen. In such case, use other mode.
 - It is not possible to operate Auto White Balance or Auto Black Balance without registering [AWB] to a USER button.
 - The contents previously set are maintained in the [Ach] or [Bch]. Perform the setting again when the recording condition has changed.



Iris/Gain adjustment

When recording a scene that is too dark (or bright) or a scene in a similar situation, manually adjust the iris and gain.

Iris adjustment

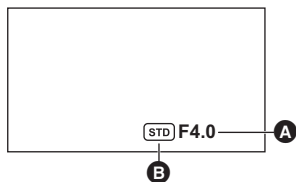

- A** Iris value
 - B** Auto iris icon*
- * It is displayed in Auto Iris Mode.

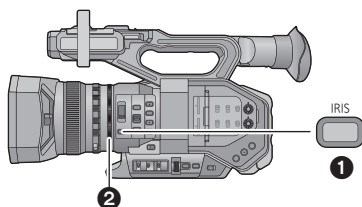

- 1** IRIS button
- 2** Iris ring

- Switch to Manual Mode. (→ 36)

1 Press the IRIS button to switch to Manual Iris Mode.

- **STD** disappears.

2 Adjust the iris by rotating the iris ring.

Iris value:

CLOSE ↔ (F16 to F3.0) ↔ **OPEN**

- Value closer to CLOSE darkens the image.
- Value closer to OPEN brightens the image.
- To return to Auto Iris Mode, press the IRIS button, or set [A.IRIS] to [ON] and switch to Auto Mode. (→ 36)

-
- This item cannot be set during Freeze Frame. (→ 81)
 - Depending on the zoom magnification, there are iris values that are not displayed.
 - In Auto Gain Mode or Auto Shutter Mode, the screen brightness may not change even if you adjust the iris. (→ 61, 64)

Customizing Auto Iris motion settings for various recording conditions

You can customize Auto Iris motion settings for various recording conditions by adjusting the settings of [A.IRIS SPEED], [AUTO IRIS LEVEL], and [AUTO IRIS LEVEL EFFECT] individually.

■ Adjusting the control speed of Auto Iris Mode

Select the menu.

 : [SW SETUP] → [A.IRIS SPEED] → desired setting

[FAST]/[NORMAL]/[SLOW]

■ Adjusting brightness during the Auto Iris Mode

1 Select the [AUTO IRIS LEVEL EFFECT] menu.

 : [SCENE FILE] → [AUTO IRIS LEVEL EFFECT]

2 Touch  /  to adjust settings.

- You can select a value between -50 and +50.
- Touch [EXIT].

3 Select the [AUTO IRIS LEVEL] menu.

 : [SCENE FILE] → [AUTO IRIS LEVEL] → [ON]

- If you select [OFF], the [AUTO IRIS LEVEL EFFECT] setting will not be applied.

4 Touch [EXIT] to complete the setting.

- You can also change the [AUTO IRIS LEVEL] setting with a USER button. ([→ 88](#))

Utilizing the USER button

It is convenient to use following functions of the USER button when it is set to Iris adjustment.

- Please refer to page [75](#) for details about setting the USER button.

USER button function	Effect
Backlight Compensation (→ 78)	Switches to automatic iris control to compensate the backlight. This will brighten the image on the screen to prevent getting dark when a backlight is hitting the subject from the back.
Spotlight (→ 79)	Switches to automatic iris control for spotlight. This will allow to clearly record an extremely bright subject.

Gain adjustment

- Use the jog dial to change the settings.

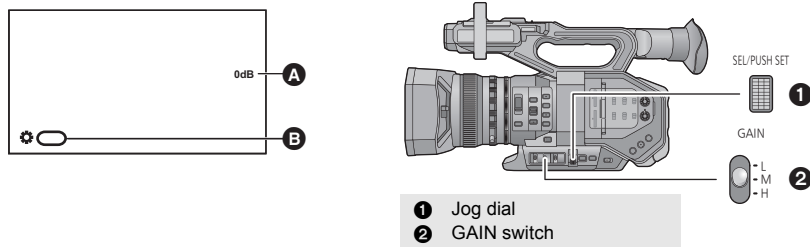

A Gain value

- The gain value changes depending on [GAIN/ISO DISPLAY CHG] setting:

– (When set to [GAIN])

In Auto Gain Mode, “AGC” is displayed; in Manual Gain Mode, the gain value is displayed in dB.

– (When set to [ISO])

In Auto Gain Mode, “ISO AUTO” is displayed; in Manual Gain Mode, the gain value is displayed in ISO.

B [GAIN]

- Switch to Manual Mode. (→ 36)

1 Slide the GAIN switch.

L: Sets the gain value to a value set in [LOW GAIN] (→ 160).

M: Sets the gain value to a value set in [MID GAIN] (→ 161).

H: Sets the gain value to a value set in [HIGH GAIN] (→ 161).

2 Push the jog dial.



3 Adjust the gain by rotating the jog dial.

Gain value:

(When [GAIN/ISO DISPLAY CHG] (→ 184) is set to [GAIN])

0dB to 24dB

- Value closer to 0dB darken the image.

- Value closer to 24dB brighten the image.

- When [EXTENDED SENSITIVITY] is set to [ON], you can set a value between –6dB and 24dB. (→ 158)

(When [GAIN/ISO DISPLAY CHG] is set to [ISO])

ISO500 to ISO8000

- Value closer to ISO500 darken the image.

- Value closer to ISO8000 brighten the image.



- When [EXTENDED SENSITIVITY] is set to [ON], you can set a value between ISO250 and ISO8000.
- When [HIGH SENS. MODE] is set to [HIGH SENS.], you can select "ISO AUTO" or a value between ISO1000 and ISO16000. (→ 158)
- The selected gain value is not maintained if any of the following operations is performed:
 - Operating the GAIN switch
 - Switching to Auto Gain Mode
 - Switching to Infrared Recording Mode (→ 84, 175)
 - Changing the [GAIN/ISO DISPLAY CHG] setting
- Auto Gain Mode is activated when one of the following operations is performed:
 - Setting [AGC] to [ON] and switching to Auto Mode (→ 36)
 - Setting any of [LOW GAIN], [MID GAIN] and [HIGH GAIN] to [AUTO] and setting the GAIN switch to the corresponding position.

-
- It is not possible to adjust the gain value using the GAIN switch and jog dial in the following situations:
 - During Freeze Frame (→ 81)
 - If the gain value is increased, the noise on the screen increases.
 - In Auto Iris Mode or Auto Shutter Mode, the screen brightness may not change even if you adjust the gain. (→ 59, 64)
 - When a negative gain value (a value between -6dB and -1dB or ISO250 and ISO400) is selected, if you set [EXTENDED SENSITIVITY] to [OFF], the gain value will be set to 0dB or ISO500.

■ Changing the maximum possible gain value for Auto Gain Mode

Select the menu.

 : [AUTO SW] → [AGC LIMIT] → desired setting

(When [GAIN/ISO DISPLAY CHG] is set to [GAIN])

[3 dB]/[6 dB]/[9 dB]/[12 dB]/[15 dB]/[18 dB]/[21 dB]/[24 dB]

(When [GAIN/ISO DISPLAY CHG] is set to [ISO])

[ISO1000]/[ISO2000]/[ISO4000]/[ISO8000]

- Settings available in High-sensitivity Recording Mode are [ISO2000], [ISO4000], [ISO8000], and [ISO16000].

Super Gain

You can use Super Gain by registering [SUPER GAIN] to a USER button. Super Gain allows you to set a Super Gain value.

[GAIN/ISO DISPLAY CHG] (→ 184) setting	Gain value in Super Gain
[GAIN]	[30 dB] or [36 dB]
[ISO]	[ISO16000] or [ISO32000]

Please refer to page 75 for details about setting the USER button.

- **Switch to Manual Mode.** (→ 36)

Press the USER button to which [SUPER GAIN] is registered or touch the applicable USER button icon.

- To cancel Super gain, press the USER button or touch the USER button icon again.

■ To change the gain value of Super Gain

Select the menu.

 : [SW SETUP] → [SUPER GAIN] → desired setting

(When [GAIN/ISO DISPLAY CHG] is set to [GAIN])

[30 dB]/[36 dB]

(When [GAIN/ISO DISPLAY CHG] is set to [ISO])

[ISO16000]/[ISO32000]

- Super Gain is not available in the following cases:
 - In Auto Gain Mode
 - During Freeze Frame (→ 81)
 - In High-sensitivity Recording Mode (→ 158)
- Super Gain is canceled if any of the following operations is performed:
 - Turning off this unit
 - Setting [HIGH SENS. MODE] to [HIGH SENS.]



Manual shutter speed

Adjust the shutter speed when recording fast-moving subjects.

- Use the jog dial to change the settings.



- A** Shutter speed
 - [SHUTTER DISPLAY CHG] allows you to switch the shutter speed display between seconds and angle. (→ 183)
- B** Auto Shutter display
 - This is displayed in Auto Shutter Mode.
- C** [SHUTTER]

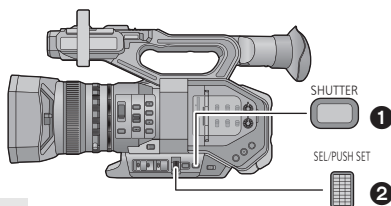

- 1** SHUTTER button
- 2** Jog dial

- Switch to Manual Mode. (→ 36)

1 Press the SHUTTER button to switch to Manual Shutter Mode.

2 Adjust the shutter speed by rotating the jog dial.

- To return to Auto Shutter Mode, press the SHUTTER button, or set [AUTO SHUTTER] to [ON] and switch to Auto Mode. (→ 36)



Shutter speed:

(When [SHUTTER DISPLAY CHG] is set to [sec])

The shutter speed varies depending on the frame rate in [REC FORMAT] or [OUTPUT FORMAT].

(→ 151, 157)

Frame rates	Shutter speed
59.94p/59.94i	1/60.0* ↔ 1/2 ↔ 1/4 ↔ 1/8 ↔ 1/15 ↔ 1/30 ↔ 1/60 ↔ ... 1/8000
29.97p	1/60.0* ↔ 1/2 ↔ 1/4 ↔ 1/8 ↔ 1/15 ↔ 1/30 ↔ 1/50 ↔ ... 1/8000
50.00p/50.00i/25.00p	1/50.0* ↔ 1/2 ↔ 1/3 ↔ 1/6 ↔ 1/12 ↔ 1/25 ↔ 1/50 ↔ ... 1/8000
23.98p/24.00p	1/48.0* ↔ 1/2 ↔ 1/3 ↔ 1/6 ↔ 1/12 ↔ 1/24 ↔ 1/48 ↔ ... 1/8000

* Synchro Scan values (→ 66)

- The shutter speed closer to 1/8000 is faster.

(When [SHUTTER DISPLAY CHG] is set to [deg])

5.0d to 360.0d

- It is possible to adjust the shutter speed in increments of 0.5d.
- The shutter speed closer to 5.0d is faster.
- You can adjust the setting faster by rotating the jog dial while pushing and holding it.

■ Shutter speed guide for fast moving subjects

Refer to the table below to reduce afterimages that appear when playback is paused.

Subject	Shutter speed
Golf or tennis shot	1/500 to 1/2000
Roller coaster	1/500 to 1/1000

■ To set an upper limit on the shutter speed in Auto Shutter Mode

Select the menu.

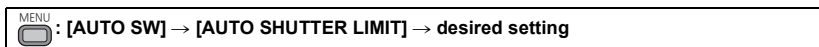

[1/100]/[1/120]*1/[1/125]*2/[1/250]/[OFF]

*1 This option is not displayed when [SYSTEM FREQ] is set to [50.00Hz].

*2 This option is not displayed when [SYSTEM FREQ] is set to [59.94Hz].

- The shutter speed cannot be adjusted in the following cases:
 - During Freeze Frame (→ 81)
- You may see a band of light around an object that is shining very bright, or highly reflective.
- During normal playback, image movement may not look smooth.
- If you record an extremely bright object or record under indoor lighting, color and screen brightness may change or a horizontal line may appear on the screen. In such cases, change settings as follows:
 - Set this unit to Auto Shutter Mode.
 - Adjust the shutter speed to 1/50, 1/60 or 1/100.
 - Adjust the Synchro Scan setting
- In Auto Iris Mode or Auto Gain Mode, the screen brightness may not change even if you adjust the shutter speed. (→ 59, 61)
- [AUTO SHUTTER LIMIT] does not work when [SHUTTER DISPLAY CHG] is set to [deg].
- When the shutter speed setting is slow, this unit may not be able to keep up with changes in the image. In such a case, set the iris, focus, and White Balance mode to manual settings.

Making adjustments with Synchro Scan

If you press the jog dial when the shutter speed is displayed as a decimal number, the Synchro Scan setting will be displayed. You can fine-adjust the shutter speed by adjusting the Synchro Scan setting. This will minimize flickering and horizontal bars in images.

- Set [SHUTTER DISPLAY CHG] to [sec]. (→ 183)

1 Press the SHUTTER button

2 When the shutter is displayed as a decimal number (e.g., 1/60.0), press the jog dial.

- The display on the screen will switch from [⚙️ SHUTTER] to [⚙️ SYNCHRO], and the Synchro Scan setting will be displayed.



3 Adjust the Synchro Scan setting by rotating the jog dial.

- You can adjust the setting faster by rotating the jog dial while pushing and holding it.
- To minimize flickering and horizontal bands, look at the screen while adjusting the shutter speed.

4 Push the jog dial to set.

- The set shutter speed will also be applied to the [SYNCHRO SCAN] menu setting. (→ 141)

Shutter speed range for the Synchro Scan setting

The shutter speed range varies depending on the size and frame rate in [REC FORMAT] or [OUTPUT FORMAT]. (→ 151, 157)

Frame rates	Shutter speed
59.94p/59.94i	(When the size for [REC FORMAT] or [OUTPUT FORMAT] is UHD (3840×2160)) 1/60.0 to 1/249.7
	(When the picture size for [REC FORMAT] or [OUTPUT FORMAT] is 1920×1080 or below) 1/60.0 to 1/249.8
29.97p	1/30.0 to 1/249.8
23.98p	1/24.0 to 1/249.6
24.00p	
50.00p/50.00i	1/50.0 to 1/250.0
25.00p	1/25.0 to 1/250.0



Audio Input

This unit can record audio in 2 ch.

It is possible to switch between built-in microphone, external microphone, or connected audio equipment for each channel.

■ About audio recording methods

The audio recording method varies depending on the [REC MODE] setting. (→ 150)

Recording mode	Audio recording method
MOV	Linear PCM (LPCM)
MP4	
AVCHD	Dolby Digital

Switching Audio Input

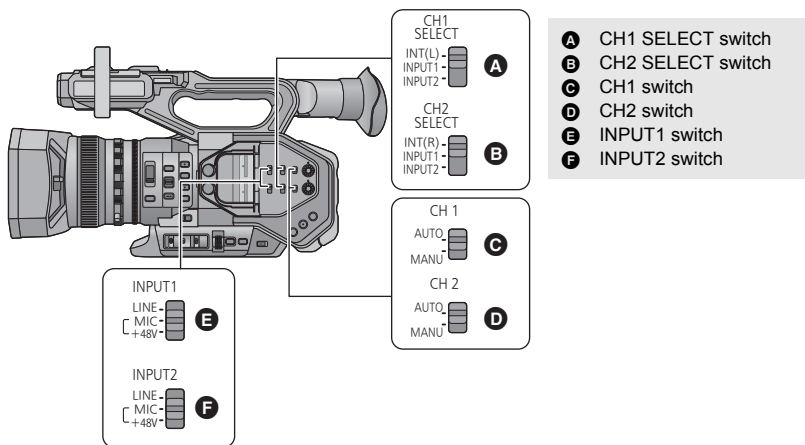

■ Using the built-in microphone

Audio is recorded with the built-in microphone (2 ch) when the CH1 SELECT switch is set to INT(L) and the CH2 SELECT switch is set to INT(R).

■ Using an external microphone or audio equipment

- 1 Connect an external microphone or audio equipment to **AUDIO INPUT1, 2** terminals (XLR 3 pin). (→ 14)
- 2 Use **INPUT1** or **INPUT2** switches to switch the connected audio input signal.

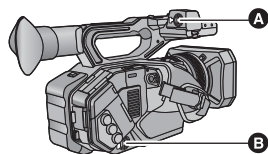

- A** AUDIO INPUT1 terminal (XLR 3 pin)
- B** AUDIO INPUT2 terminal (XLR 3 pin)

LINE^{*1}: Audio equipment is connected

MIC^{*2}: An external microphone is connected

+48V^{*2}: When using a phantom microphone (which requires a power supply of +48 V)

*1 The input level varies depending on the [INPUT1 LINE LEVEL] or [INPUT2 LINE LEVEL] setting. (→ 178)

*2 The input level varies depending on the [INPUT1 MIC LEVEL] or [INPUT2 MIC LEVEL] setting. (→ 178)

- 3 Use the **CH1 SELECT** switch to select the input signal to be recorded to audio channel 1.

INT(L): Audio from the built-in microphone L (left) ch is recorded to audio channel 1.

INPUT1: Audio from a device connected to AUDIO INPUT1 terminal (XLR 3 pin) is recorded to channel 1.

INPUT2: Audio from a device connected to AUDIO INPUT2 terminal (XLR 3 pin) is recorded to channel 1.

- 4 Use the **CH2 SELECT** switch to select the input signal to be recorded to audio channel 2.

INT(R): Audio from the built-in microphone R (right) ch is recorded to audio channel 2.

INPUT1: Audio from a device connected to AUDIO INPUT1 terminal (XLR 3 pin) is recorded to channel 2.

INPUT2: Audio from a device connected to AUDIO INPUT2 terminal (XLR 3 pin) is recorded to channel 2.

■ Table of audio input patterns

Switch setting		Channel or terminal used for signal input	
CH1 SELECT switch	CH2 SELECT switch	Audio channel 1	Audio channel 2
INT(L)	INT(R)	Internal microphone Lch	Internal microphone Rch
	INPUT1	Internal microphone Lch	AUDIO INPUT1 terminal
	INPUT2	Internal microphone Lch	AUDIO INPUT2 terminal
INPUT1	INT(R)	AUDIO INPUT1 terminal	Internal microphone Rch
	INPUT1	AUDIO INPUT1 terminal	AUDIO INPUT1 terminal
	INPUT2	AUDIO INPUT1 terminal	AUDIO INPUT2 terminal
INPUT2	INT(R)	AUDIO INPUT2 terminal	Internal microphone Rch
	INPUT1	AUDIO INPUT2 terminal	AUDIO INPUT1 terminal
	INPUT2	AUDIO INPUT2 terminal	AUDIO INPUT2 terminal

To remove the external microphone, etc., from the AUDIO INPUT1, 2 terminals (XLR 3 pin)

Remove while pushing on the PUSH section of the AUDIO INPUT1, 2 terminals (XLR 3 pin).

- Set the input signal to built-in microphone by switching the CH1 SELECT, CH2 SELECT switches to INT (L) or INT (R) after removing the external microphone. Audio will not be recorded when motion picture is recorded without switching.

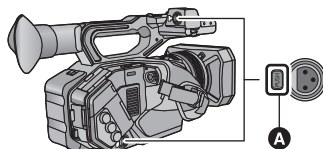

A PUSH section

- Set INPUT1, 2 switches to LINE or MIC if you connect equipment not compatible with +48 V. You can damage this unit or such equipment if you leave the setting at +48V.
- This unit is turned off when a problem occurs with the +48 V power supply.
- The battery will discharge faster if you use a phantom microphone.

Adjusting the audio input level

Selecting an adjustment method

You can set how to adjust the audio input level for each audio channel. Use the CH1 switch for channel 1 and the CH2 switch for channel 2.

1 Set the position of the CH1 or CH2 switch.

AUTO: Adjusts the level automatically.

MANU: Adjusts the level manually.

2 (If you have set to MANU)

Adjust the input level operating the AUDIO LEVEL CH1/AUDIO LEVEL CH2 knobs.

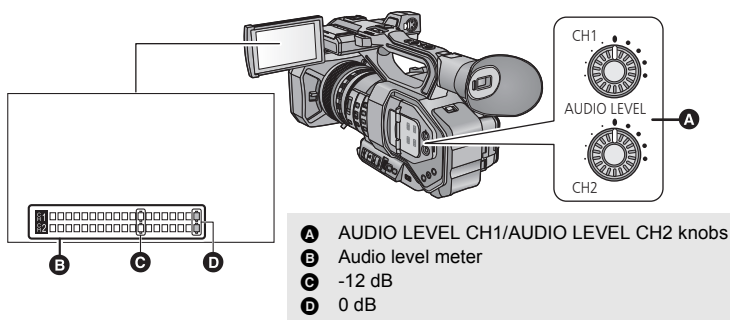

- Adjust confirming the audio level meter.

Using the ALC function

ALC can reduce audio noise. For audio channel 1, select [AUDIO ALC CH1]; for audio channel 2, select [AUDIO ALC CH2].

Select the menu.

MENU



: [AUDIO SETUP] → [AUDIO ALC CH1] or [AUDIO ALC CH2] → desired setting

[ON]: Enables ALC, allowing you to record audio with reduced noise.

[OFF]: Allows you to record natural-sounding audio.

■ To set the ALC function to both audio channels 1 and 2

If you set [AUDIO ALC LINK] to [ON], when ALC works for either of the audio channels, it will also work for the other audio channel.

- 1 Set CH1 switch or CH2 switch to MANU.**
- 2 Set [AUDIO ALC CH1]/[AUDIO ALC CH2] to ON.**
- 3 Select the menu.**

MENU



: [AUDIO SETUP] → [AUDIO ALC LINK] → [ON]

Counter display

You can change a counter display that indicates how much time has elapsed during recording or playback.

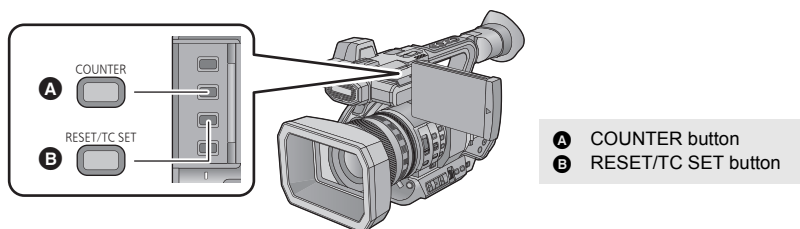

Press the COUNTER button to switch the counter display.

- The display will be switched in the following order: Time Code → User Information* → Recording Counter → Off.

Counter display	Indications
Time Code	TC 00:00:00:00 or TC 00:00:00.00 <ul style="list-style-type: none"> • Display will change depending on the setting of the [DF MODE]. (→ 72)
User Information* (→ 73)	UB 00 00 00 00
Recording Counter (→ 74)	(In Recording Mode) 0:00:00 or SCN 0:00:00 (In Playback Mode) SCN 0:00:00 <ul style="list-style-type: none"> • In Recording Mode, display will change depending on the setting of the [REC COUNTER]. • In Playback Mode, display will return to SCN 0:00:00 for each scene.

* This is displayed only when [REC MODE] is set to [AVCHD]. (→ 150)

Setting the Time Code

Time code will display the recording time in hours, minutes, seconds, and frames.

TC 00:00:00:00 (hour : minute : second : frame [NDF])

TC 00:00:00.00 (hour : minute : second . frame [DF])

- The number of frames (frame count per second) varies depending on the frame rate in [REC FORMAT] or [OUTPUT FORMAT]. (→ 151, 157)

Frame rates	Frame
59.94p/59.94i/29.97p	0 to 29
50.00p/50.00i/25.00p	0 to 24
23.98p/24.00p	0 to 23

[DF MODE]



Select the compensation mode for the time code.

- Set [SYSTEM FREQ] to [59.94Hz]. (→ 150)

Select the menu.

: [RECORD SETUP] → [DF MODE] → desired setting

[DF]:	Time code is compensated in accordance with the actual time. It is mainly used for broadcasting such as TV programs.
[NDF]:	It will not compensate the time code. (There will be a difference from the actual time)

- This item will be set to [NDF] automatically in following cases:
 - When the frame rate in [REC FORMAT] or [OUTPUT FORMAT] is 23.98p or 24.00p (→ 151, 157)
 - During the Interval Recording (→ 173)
- This item will be automatically set to [NDF] and will not be displayed as a menu item when [SYSTEM FREQ] is set to [50.00Hz]. (→ 150)

[TCG]



Sets the way the time code will move.

Select the menu.

: [RECORD SETUP] → [TCG] → desired setting

[FREE RUN]*¹:	It will constantly move.
[REC RUN]:	It will move only when recording.

*¹ If the frame rate in [REC FORMAT] or [OUTPUT FORMAT] is set to 23.98p, a slight time error may occur when switching to Playback Mode. (→ 151, 157)

- It is automatically set to [FREE RUN] in following cases:
 - When PRE-REC is enabled (→ 86, 174)
 - When [2 SLOTS FUNC.] is set to [BACKGROUND] (→ 170)
- It is automatically set to [REC RUN] in following cases:
 - In Variable Frame Rate Mode*² (→ 91)
 - During the Interval Recording (→ 173)

*² [FREE RUN] is also available if the number of frames for the frame rate in [REC FORMAT] and the number of frames for Variable Frame Rate Mode are the same.

Example: When [REC FORMAT] is set to [FHD 1080/59.94p 50M] and the frame rate is set to [60]

- The time code will reset when the built-in lithium battery is exhausted when it is set to [FREE RUN].

[TC PRESET]



You can set the initial time code.

1 Select the menu.

MENU: [RECORD SETUP] → [TC PRESET]

2 Touch the item to set and change with ▲ / ▼.

- It will be set to 00h00m00s00f when the RESET/TC SET button is pressed.
- "h" is an abbreviation for hour, "m" for minute, "s" for second and "f" for frame.

3 Touch [EXIT] to complete the setting.

- This unit will adjust the time code in accordance with the frame rate of the [REC FORMAT] (→ 151) or [OUTPUT FORMAT] (→ 157). Therefore, it may not be continuous from the previous final time code when the recording format is changed.
- If the frame rate in [REC FORMAT] or [OUTPUT FORMAT] is set to 23.98p, set the number of frames to [00] or a multiple of 4. If you enter a different value, time code will not be recorded correctly.

Setting the User Information

Eight digit hexadecimal alphanumeric can be entered and displayed as a memo information such as dates, control numbers, etc., into the User Information.

UB 00 00 00 00

- This is displayed only when [REC MODE] is set to [AVCHD]. (→ 150)

[UB PRESET]



You can set the User Information.

- Set [REC MODE] to [AVCHD]. (→ 150)

1 Select the menu.

MENU: [RECORD SETUP] → [UB PRESET]

2 Touch the item to set and change with ▲ / ▼.

- You can use numbers from 0 to 9 and letters from A to F.
- It will be set to 00 00 00 00 when the RESET/TC SET button is pressed.

3 Touch [EXIT] to complete the setting.

Setting the Recording Counter

Recording Counter will display the recording time in seconds.

0:00:00 (hour : minute : second (When [REC COUNTER] is set to [TOTAL]))

SCN 0:00:00 (hour : minute : second (When [REC COUNTER] is set to [SCENE]))

[REC COUNTER]



Select the counting method during the recording.

Select the menu.

MENU:  : [DISP SETUP] → [REC COUNTER] → desired setting

[TOTAL]: The count continues to increase until the Recording Counter is reset.

[SCENE]: Resets the Recording Counter at start of recording. Counts the time of each recording session.

To reset the Recording Counter for the Recording Mode

The Recording Counter will be set to 0:00:00 when the RESET/TC SET button is pressed while displaying the counter.

Synchronizing the time code with an external device



You can synchronize the default time code during multi-camera recording.

- In the following section, the device with the reference time code is referred to as “master”, while the device to be synchronized is referred to as “slave”.

1 Connect the TC PRESET IN/OUT terminals of the two devices with a BNC cable (commercially-available), and turn them on.

- Apply the same [REC FORMAT], [OUTPUT FORMAT] and [DF MODE] settings to the two devices. (→ 72, 151, 157)

2 (On the master device) Select the [TCG] menu.

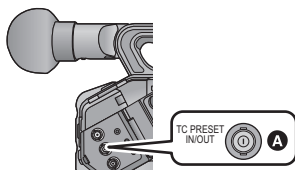

A TC PRESET IN/OUT terminal

MENU:  : [RECORD SETUP] → [TCG] → [FREE RUN]

3 (On the master device) Select the [EXT TC LINK] menu.

MENU:  : [RECORD SETUP] → [EXT TC LINK] → [MASTER]

- The time code will be output from the TC PRESET IN/OUT terminal.
- To cancel the output of the time code, touch [EXIT].

4 (On the slave device) Select the [EXT TC LINK] menu.

MENU : [RECORD SETUP] → [EXT TC LINK] → [SLAVE]

- [TCG] will be set to [FREE RUN].

5 (On the slave device)

Press the RESET/TC SET button.

- [TC LINK OK] will be displayed and the time code will be synchronized with that of the master device.
- When the time code is not synchronized correctly, [TC LINK NG] is displayed.
- To cancel the operation without synchronizing the time code, touch [EXIT].

- Use a commercially-available, double-shielded BNC cable equivalent to 5C-FB.
- [EXT TC LINK] cannot be set to [SLAVE] in the following cases:
 - In Variable Frame Rate Mode (→ 91)
 - During the Interval Recording (→ 173)

Recording

USER button

Each of the USER button can register one function from the 43 available functions.

- There are 9 USER buttons (USER1 to 8 and AWB) on the main body and 4 USER button icons (USER10 to USER13) displayed on the LCD monitor.

Setting the USER button

1 Select the menu.

MENU : [USER SW] → Name of the USER button you want to use

- USER9 corresponds to the AWB.
- It is not possible to register functions to [USER10] to [USER13] in Playback Mode.

2 Touch the item to register.

- For the functions of the USER button that can be registered, refer to page 77.
- Touch [INHIBIT] if not registering.
- Next (Previous) page can be displayed by touching ▲ / ▼.

3 Touch [EXIT] to complete the setting.

- The tables below show the default settings.

USER1 button	[DRS]
USER2 button	[ATW]
USER3 button	[BACKLIGHT]
USER4 button	[FOCUS MACRO]
USER5 button	[O.I.S.]
USER6 button	[ZEBRA]
USER7 button	[WFM]

USER8 button	[REC CHECK]
AWB button (USER9)	[AWB]
USER10 button	[FRZ FRAME]
USER11 button	[EVF/LCD DETAIL]
USER12 button	[ATW LOCK]
USER13 button	[MENU]

- Performing [ALL] in [INITIAL SET] restores these default settings. (→ 189)

Using the USER button

To use the function assigned to a USER button or USER button icon, press the applicable USER button (one of the USER buttons 1 to 8 or the AWB button), or touch the applicable USER button icon (one of the USER button icons 10 to 13) while operation icons are displayed.

(When you use the USER1 to USER7 button)

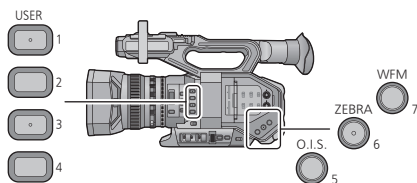

(When you use the USER8 button)

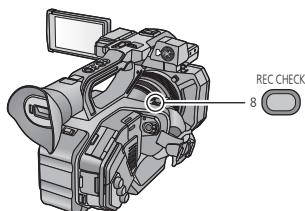

(When you use the AWB button)

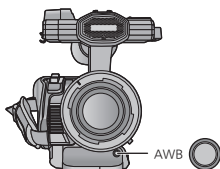

(When you use the USER10 to USER13 button)

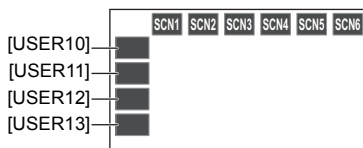

- To cancel, press the USER button or touch the USER button icon again.
- For canceling or using of the following functions for the USER buttons, refer to each page.
 - Black Fade (→ 79)
 - White Fade (→ 79)
 - Recording Check (→ 80)
 - Last Scene Delete (→ 80)
 - Area Mode (→ 82)
 - Focus Transition (→ 52)
 - Background (→ 85)
 - WFM (→ 87)
 - Zebra (→ 88)
 - Scene File (→ 89)
 - Auto Recording (→ 90)
 - AF Area Range Adjustment (→ 90)
 - Digital Zoom (→ 93)
 - Log View Assist (→ 94)
 - LCD/EVF Output (→ 24)
 - Push Auto (→ 47, 48)
 - Auto White Balance (→ 55, 58)

■ Switch display/not-display of the USER buttons

Display/not-display of the USER button icons in the LCD monitor can be switched.

Select the menu.

MENU: [USER SW] → [USER BUTTON DISPLAY] → [ON] or [OFF]

■ Check the setting of the USER buttons

To check the USER button (USER1 to 8 and AWB) settings on the recording screen, use the DISP/MODE CHK switch to display the mode information screen. (→ 97)

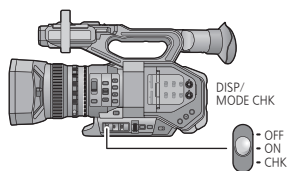

Functions of the USER button

■ List of USER button functions

Item	Icon	Function
[INHIBIT]	[INH]	Invalid
[FOCUS MACRO]	[F.Macro]	Focus Macro
[BACKLIGHT]	[B.Light]	Backlight Compensation
[SPOTLIGHT]	[S.Light]	Spotlight
[BLACK FADE]	[B.FD]	Black Fade
[WHITE FADE]	[W.FD]	White Fade
[ATW]	[ATW]	Auto Tracking White Balance
[ATW LOCK]	[ATW.L]	ATW Lock
[FOCUS ASSIST 1]	[FA1]	Focus Assist 1
[FOCUS ASSIST 2]	[FA2]	Focus Assist 2
[REC CHECK]	[REC.C]	Recording Check
[LAST SCN DEL]	[LstDel]	Last Scene Delete
[DRS]	[DRS]	DRS
[FRZ FRAME]	[FRZ]	Freeze Frame
[SUPER GAIN]	[S.Gain]	Super Gain ^{*1}
[AREA]	[AREA]	Area Mode
[FOCUS TRANS]	[F.Tran]	Focus Transition ^{*2}
[CAPTURE]	[Capture]	Capture
[EVF/LCD DETAIL]	[DETAIL]	EVF/LCD detail
[IR REC]	[IR REC]	Infrared Recording
[LEVEL GAUGE]	[Level]	Level Gauge
[BACKGROUND]	[Backgr]	Background
[FLASH BAND]	[FBC]	Flash band compensation
[PRE-REC]	[PRE-REC]	PRE-REC
[WFM]	[WFM]	WFM
[FAST ZOOM]	[F.ZOOM]	Fast Zoom
[EVF ON/OFF]	[EVF SW]	EVF ON/OFF
[A.IRIS LEVEL]	[A.IRIS]	Auto Iris Level
[ZEBRA]	[ZEBRA]	Zebra
[O.I.S.]	[O.I.S.]	Optical Image Stabilizer
[SCENE FILE]	[SCN FILE]	Scene File
[AUTO REC]	[AutoRec]	Auto Rec

*1 Not available in Auto Mode

*2 Not available for Auto Focus

Item	Icon	Function
[AF AREA]	[AF Area]	AF area width adjustment
[VFR]	[VFR]	Variable Frame Rate Mode
[D.ZOOM]	[D.ZM]	Digital Zoom
[i.ZOOM]	[i.Zoom]	i.Zoom
[USB MODE]	[USB]	USB Mode*
[LOG VIEW ASSIST]	[LogView]	Log View Assist
[LCD/EVF OUTPUT]	[LCD/EVF]	LCD/EVF Output
[HISTOGRAM]	[HIST]	Histogram
[PUSH AUTO]	[PushAuto]	Push Auto
[SLOT SEL]	[SlotSel]	Slot Selection
[AWB]	[AWB]	Auto White Balance
[MENU]	[MENU]	Menu

* Not available during AG ROP application connection.

- The following USER button function can also be set from the menu.
 - [FOCUS MACRO] (→ 165)
 - [DRS] (→ 148)
 - [INFRARED REC] (→ 175)
 - [LEVEL GAUGE] (→ 184)
 - [EVF/LCD DETAIL] (→ 45)
 - [FLASH BAND COMPENSATION] (→ 149)
 - [PRE-REC] (→ 174)
 - [WFM] (→ 166)
 - [FAST ZOOM] (→ 41)
 - [AUTO IRIS LEVEL] (→ 60)
 - [ZEBRA] (→ 166)
 - [O.I.S.] (→ 162)
 - [SCENE FILE] (→ 140)
 - [AF AREA WIDTH] (→ 47)
 - [VFR MODE] (→ 140)
 - [i.Zoom] (→ 41)
 - [USB MODE] (→ 189)
 - [LCD/EVF OUTPUT] (→ 24)
 - [HISTOGRAM] (→ 185)

Focus Macro

- Register “Focus Macro” to a USER button. (→ 75)

You can enable/disable Focus Macro.

-  is displayed on the screen when [ON] is selected.

Backlight Compensation

- Register “Backlight Compensation” to a USER button. (→ 75)

Switches to automatic iris control to compensate the backlight.

This makes the image brighter to prevent darkening of a backlit subject.

-  appears when it is set.
- It will return to standard Auto Iris Mode () when it is canceled. (→ 59)

- This item cannot be set during Freeze Frame. (→ 81)



Spotlight



- **Register “Spotlight” to a USER button. (→ 75)**

Switches to automatic iris control for spotlight.

Very bright object is recorded clearly.

-  appears when it is set.
- It will return to standard Auto Iris Mode () when it is canceled. (→ 59)

-
- This item cannot be set during Freeze Frame. (→ 81)

Black Fade



- **Register “Black Fade” to a USER button. (→ 75)**

Fade in/fade out effect (black) can be added to the video and audio that is being recorded.

Press USER button or touch USER button icon in the recording screen.

- Fade out will start, and fade in will start after completing the fade out.
- It will fade out when the button is pressed and held, and fade in will start when the button is released.

-
- Recording will not start even if the fade out is started. It is possible to press the recording start/stop button during the fade in or fade out.
 - Black Fade is not possible in following cases:
 - In Variable Frame Rate Mode (→ 91)
 - During the Interval Recording (→ 173)
 - The thumbnails of scenes recorded using fade in become black.

White Fade



- **Register “White Fade” to a USER button. (→ 75)**

Fade in/fade out effect (white) can be added to the video and audio that is being recorded.

Press USER button or touch USER button icon in the recording screen.

- Fade out will start, and fade in will start after completing the fade out.
- It will fade out when the button is pressed and held, and fade in will start when the button is released.

-
- Recording will not start even if the fade out is started. It is possible to press the recording start/stop button during the fade in or fade out.
 - White Fade is not possible in following cases:
 - In Variable Frame Rate Mode (→ 91)
 - During the Interval Recording (→ 173)
 - The thumbnails of scenes recorded using fade in become white.

ATW



- **Register “ATW” to a USER button. (→ 75)**

The White Balance can be changed to ATW. (→ 55)

-
- This function is not available when the White Balance mode is set to [ATW LOCK].

ATW Lock



- Register “ATW Lock” to a USER button. (→ 75)

This sets the White Balance mode to [ATW LOCK].(→ 57)

Focus Assist 1



- Register “Focus Assist 1” to a USER button. (→ 75)

You can set the Focus Assist. (→ 48)

- You can set the Focus Assist method in [FOCUS ASSIST 1] in the [SW SETUP] menu.

Focus Assist 2



- Register “Focus Assist 2” to a USER button. (→ 75)

You can set the Focus Assist. (→ 48)

- You can set the Focus Assist method in [FOCUS ASSIST 2] in the [SW SETUP] menu.

-
- When [FOCUS ASSIST 1] in the [SW SETUP] menu is set to [BOTH], the USER button is disabled.

Recording Check



- Register “Recording Check” to a USER button. (→ 75)

- Set [OUTPUT BITS] to [4:2:2(8bit)]. (→ 31)

Approximately 2 seconds at the end of the video recorded last can be played back. It will return to recording screen once the playback is completed.

-
- Playback operation is not possible during the Recording Check.
 - Recording Check is not possible in following cases:
 - When the unit is turned on/off
 - When the THUMBNAIL button is pressed
 - When the SD card is inserted/removed
 - When [OUTPUT BITS] is set to [4:2:2(10bit)]
 - When the setting of [REC FORMAT] is changed (→ 151)
 - Set [2 SLOTS FUNC.] to [SIMULTANEOUS] or [BACKGROUND]. (→ 170)
 - PRE-REC is used (→ 86, 174)
 - During the Interval Recording (→ 173)
 - During Freeze Frame (→ 81)

Last Scene Delete



- Register “Last Scene Delete” to a USER button. (→ 75)

- Set [OUTPUT BITS] to [4:2:2(8bit)]. (→ 31)

The motion picture recorded last can be deleted.

Deleted scenes cannot be restored.

- 1 Press USER button or touch USER button icon in the recording screen.
- 2 Touch [YES].

- It will return to recording screen without deleting by touching [NO].

-
- Last Scene Delete is not possible in following cases:
 - When the unit is turned on/off
 - When the THUMBNAIL button is pressed
 - When the SD card is inserted/removed
 - When [OUTPUT BITS] is set to [4:2:2(10bit)]
 - When the setting of [REC FORMAT] is changed (→ 151)
 - Set [2 SLOTS FUNC.] to [SIMULTANEOUS], [BACKGROUND] or [DUAL CODEC]. (→ 170)
 - During the Interval Recording (→ 173)

DRS



- **Register “DRS” to a USER button. (→ 75)**

Selects the DRS (Dynamic Range Stretcher) function.

It is possible to expand the dynamic range by compressing the video signal level of the highly illuminated area that gets washed out with standard recording.

-
- This item cannot be set in Variable Frame Rate Mode. (→ 91)
 - If there are extremely dark or bright parts or the brightness is insufficient, the effect may not be clear.
 - It is also possible to adjust the compression level of the highly illuminated area by changing the [DRS EFFECT] setting. (→ 148)

Freeze Frame



- **Register “Freeze Frame” to a USER button. (→ 75)**

Freezes the image on the unit.

- will appear on the screen and flash.

-
- If you record a motion picture during Freeze Frame, the frozen image and sounds will be recorded.
 - You can perform the following camera operations during Freeze Frame. Other camera operations will be disabled.
 - Recording motion pictures
 - Canceling Freeze Frame
 - Operating the FOCUS A/M/∞ switch
 - Operating the WHITE BAL switch
 - Operating the GAIN switch
 - This function is not available in the following cases:
 - When using Focus Assist (→ 48)
 - In Variable Frame Rate Mode (→ 91)
 - During Log View Assist (→ 94)
 - During the Interval Recording (→ 173)
 - When color bars are displayed. (→ 96)
 - Freeze Frame is canceled in the following cases:
 - Turning off the unit
 - When the THUMBNAIL button is pressed
 - Setting this unit to Variable Frame Rate Mode
 - When [USB MODE SELECT] is set to [DEVICE] and this unit is connected to a PC. (→ 123)

Super Gain



- Register “Super Gain” to a USER button. (→ 75)
 - Switch to Manual Mode. (→ 36)
- This changes the gain value to a [SUPER GAIN] value. (→ 62)

Area Mode



You can apply a variety of effects to the subject you touch.

■ Setting an Area Mode effect

You can select the following menu items to set an effect to be applied when you touch the subject.

 : [SW SETUP] → [AREA MODE] → **desired setting**

[INH]:	Does not apply any effects of Area Mode.
[FOCUS]:	Optimizes the focus automatically for the subject you touch
[IRIS]:	Optimizes the iris automatically for the subject you touch.
[Y GET]:	Displays the luminance level of the subject you touch.
[FOCUS/IRIS]:	Optimizes the focus and iris automatically for the subject you touch.
[FOCUS/Y GET]:	Optimizes the focus automatically for the subject you touch and displays the luminance level of the subject.

■ Using Area Mode

- Register “Area Mode” to a USER button. (→ 75)

1 Press the applicable USER button or touch the applicable USER button icon on the recording screen.

- Area Mode will be enabled and  will be displayed.

2 Touch the recording screen.

- The area frame will be displayed on the part you have touched. The effect of the selected menu item will be applied.

To turn off Area Mode

(With a USER button)

Press the USER button

(With a USER button icon)

- 1 Touch and hold the recording screen to display operation icons.
- 2 Touch the USER button icon.

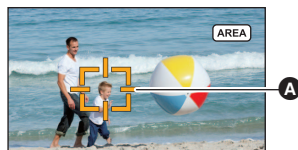

A Area frame

To change the size of the area frame

You can rotate the jog dial to change the size of the area frame.

- The area frame is available in three sizes.

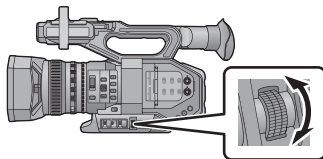

- Area Function is not possible in following cases:
 - In Variable Frame Rate Mode (→ 91)
 - When a remote control (commercially-available) is connected (→ 114)
 - During AG ROP application connection (→ 131)
- Area mode is canceled in following cases:
 - If you turn the unit off
 - If you press the THUMBNAIL button
 - If you switch to a [REC FORMAT] setting with a frame rate of 24.00p. (→ 151)
 - If you switch to an [OUTPUT FORMAT] setting with a frame rate of 24.00p. (→ 157)
 - When the setting of [ASPECT CONVERT] is changed (→ 158)
 - When [USB MODE SELECT] is set to [DEVICE] and this unit is connected to a PC. (→ 123)
- When using Area Mode, even if you set [ZEBRA] to [MARKER], the luminance display frame will not be displayed. (→ 88, 166)
In addition, the luminance level will not be displayed if [AREA MODE] is set to [FOCUS], [IRIS] or [FOCUS/IRIS].

Focus Transition



- Register “Focus Transition” to a USER button. (→ 75)
- Switch to Manual Focus Mode. (→ 44)

With Focus Transition, you can move the current focus position to a pre-registered focus position. (→ 52)

Capture



- Register “Capture” to a USER button. (→ 75)

You can record still pictures or create still pictures from recorded motion pictures. (→ 34, 107)

EVF/LCD detail



- Register “EVF/LCD detail” to a USER button. (→ 75)

[EVF/LCD DETAIL] helps you achieve focus easier by emphasizing the outlines of an image displayed on the LCD monitor or the viewfinder. (→ 45)

- These settings will not affect the images actually recorded.



● **Register “Infrared Rec” to a USER button. (→ 75)**

This changes the Infrared Recording Mode setting.

- This unit operates as follows in Infrared Recording Mode:
 -  appears on the screen.
 - The iris, gain, and shutter speed are adjusted automatically.
 - When [AUTO SLOW SHTR] is set to [ON], the shutter speed will be automatically adjusted to 1/30, 1/24 or 1/25. (→ 169)

- It is recommended to use a tripod.
- It takes longer to focus with Auto Focus in dark locations.
- Do not use this function in a bright location. Doing so may cause malfunction.
- You can record a clear image by positioning the center area of the screen over the subject.
- [INFRARED REC] cannot be set in Variable Frame Rate Mode. (→ 91)
- Focus values may not be displayed correctly in Infrared Recording Mode. (→ 44)
- The following menu items are not available in Infrared Recording Mode:
 - [SCENE FILE] (→ 140)
 - [MASTER DETAIL] (→ 141)
 - [DETAIL CORING] (→ 142)
 - [SKIN TONE DTL] (→ 142)
 - [V DETAIL LEVEL] (→ 142)
 - [KNEE APE LEVEL] (→ 143)
 - [RB GAIN CONTROL SETTING] (→ 143)
 - [CHROMA LEVEL] (→ 144)
 - [CHROMA PHASE] (→ 144)
 - [MATRIX] (→ 144)
 - [COLOR CORRECTION SETTING] (→ 145)
 - [MASTER PED] (→ 146)
 - [GAMMA MODE] (→ 146)
 - [BLACK GAMMA] (→ 147)
 - [BLACK GAMMA RANGE] (→ 147)
 - [KNEE MODE] (→ 147)
 - [KNEE MASTER POINT] (→ 147)
 - [KNEE MASTER SLOPE] (→ 148)
 - [DRS] (→ 81, 148)
 - [DRS EFFECT] (→ 148)
 - [AUTO IRIS LEVEL] (→ 60, 88)
 - [AUTO IRIS LEVEL EFFECT] (→ 60)
 - [V-Log L MODE] (→ 149)
 - [ATW TARGET R] (→ 57)
 - [ATW TARGET B] (→ 57)
 - [WB VAR] (→ 163)
 - [MF ASSIST] (→ 51)
 - [CUSTOM AF] (→ 46)
 - [AF SPEED] (→ 46)
 - [AF SENSITIVITY] (→ 46)
 - [FOCUS TRANSITION] (→ 52)
- The following functions are not available in Infrared Recording Mode:
 - Focus Transition (→ 52)
 - Change the White Balance mode (→ 55)
 - Iris adjustment (→ 59)
 - Gain adjustment (→ 61)
 - AGC Limit (→ 62)
 - Shutter speed adjustment (→ 64)
 - ND filter (→ 97)
 - Backlight Compensation (→ 78)
 - Spotlight (→ 79)
 - ATW (→ 79)
 - ATW Lock (→ 57)
 - Super Gain (→ 62)

Level Gauge



- Register “Level Gauge” to a USER button. (→ 75)

This function displays the horizontal/vertical tilt of the unit with the electronic level.

- To correct the tilt

(Horizontal direction)

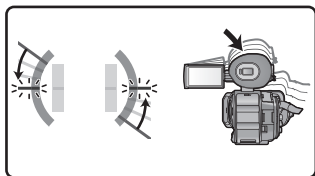

When correcting the leftward tilt

(Vertical direction)

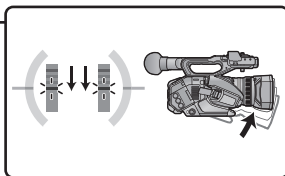

When correcting the downward tilt

- The horizontal tilt display **A** and vertical tilt display **B** appear yellow when there is a tilt, and appear green when there is almost no tilt.
- The maximum tilt display angles are approximately 45° in horizontal direction and 10° in vertical direction.
- The electronic level does not affect the actual recorded images.

- This function is not available in the following cases:

- During Freeze Frame (→ 81)
- When color bars are displayed. (→ 96)

- If [SELF SHOOT] (→ 186) is set to [MIRROR], the electronic level will not be displayed when you record yourself.

- Even when the tilt is in the corrected state, an error of approximately 1° may occur.

- In the following cases, the electronic level may not be displayed correctly:

- When moving this unit
- When pointing this unit up or down at an angle closer to perpendicular

Background



- Register “Background” to a USER button. (→ 75)

When [2 SLOTS FUNC.] is set to [BACKGROUND], you can start/stop background recording.

- When the recording destination of motion pictures is set to [SD CARD 1] in [MEDIA SELECT] (→ 32), [SD CARD 2] will be used for background recording.

The following instructions assume that the recording destination of motion pictures is set to [SD CARD 1].

- Set [2 SLOTS FUNC.] to [BACKGROUND]. (→ 170)

BACKGR is displayed for SD CARD 2.

(To start background recording)

Press the applicable USER button or the applicable USER button icon.

- Background recording will start on the SD card in SD CARD 2. (**BACKGR** will be displayed in red.)

(To stop background recording)

While motion picture recording to [SD CARD 1] is stopped, press and hold the applicable USER button or the USER button icon.

- Please refer to page 171 about Background recording.

Flash band compensation



- **Register “Flash band compensation” to a USER button. (→ 75)**

If you set this item to [ON], you can compensate for and reduce flash band, a phenomenon that creates markedly different levels of luminance between the top and bottom of the image when recording is performed in an environment where another camera is firing its flash.

- FBC appears on the screen.

- This function is not available in the following cases:

- When the frame rate in [REC FORMAT] or [OUTPUT FORMAT] is 29.97p, 23.98p, 24.00p or 25.00p (→ 151, 157)
- When using [DIGITAL ZOOM] (→ 93)
- In Variable Frame Rate Mode (→ 91)

- The setting will be turned off in the following cases:

- If you turn the unit off
- If you press the THUMBNAIL button
- When [USB MODE SELECT] is set to [DEVICE] and this unit is connected to a PC. (→ 123)

- [SHUTTER DISPLAY CHG] is fixed to [sec]. (→ 183)

- Manual Shutter Mode will be activated. This will fix the shutter speed to 1/60 or 1/50.

PRE-REC



- **Register “PRE-REC” to a USER button. (→ 75)**

- **Set [OUTPUT BITS] to [4:2:2(8bit)]. (→ 31)**

This allows the recording of an image and audio to start before you press the recording start/stop button. AVCHD scenes will be recorded from approximately 3 seconds before the operation, while MOV/MP4 will be recorded from approximately 4 seconds before the operation.

- [P-] is displayed on the screen. After you start recording, the display changes to [P-REC].

- **Aim the unit at the subject beforehand.**

- There is no beep sound.

- This function is not available in the following cases:

- When you set [OUTPUT BITS] to [4:2:2(10bit)]
- In Variable Frame Rate Mode (→ 91)
- When [2 SLOTS FUNC.] is set to [BACKGROUND] (→ 170)
- During the Interval Recording (→ 173)

- In the following cases, a 3 second image that precedes the recording of an AVCHD scene or a 4 second scene that precedes the recording of an MOV/MP4 scene may not be recorded:

- When 3 hours has just passed since you set PRE-REC
- If the length of time from when [PRE-REC] is set to [ON] to when you start recording is too short
- If the length of time from when you display the recording screen by turning it off and on or pressing the THUMBNAIL button to when you start recording is too short since you set PRE-REC

- Images displayed on the thumbnail in Playback Mode will differ from the motion pictures displayed at the start of playback.



- Register “WFM” to a USER button. (→ 75)

This function displays waveforms on the LCD monitor.

Press USER button in the recording screen.

- When [WFM TYPE] is set to [WAVE] or [VECTOR], each press of the button enables/disables WFM.
- When [WFM TYPE] is set to [WAVE/VECTOR], each press of the button switches the setting. WAVE (wave display) → VECTOR (vector display) → OFF

- If you have enabled WFM by touching the applicable USER button icon, set [WFM] to [OFF] to disable it.
- This function is not available in the following cases:
 - When using the viewfinder
 - When recording yourself (→ 28)
 - When using Focus Assist (→ 48)
 - During Freeze Frame (→ 81)
 - When color bars are displayed. (→ 96)
- [WFM] will be canceled in the following cases:
 - If you turn the unit off
 - If you press the THUMBNAIL button
 - When [USB MODE SELECT] is set to [DEVICE] and this unit is connected to a PC. (→ 123)

■ To change the type of WFM

Select the menu.

 : [SW SETUP] → [WFM TYPE] → desired setting

[WAVE]:	Displays waveforms as waves.
[VECTOR]:	Displays waveforms as vectors.
[WAVE/VECTOR]:	Switches the setting each time the applicable USER button is pressed.

- This function is not available in the following cases:
 - When using Focus Assist (→ 48)
 - During Freeze Frame (→ 81)
 - When color bars are displayed (→ 96)

■ To change the display position of WFM

Select the menu.

 : [SW SETUP] → [WFM POSITION] → desired setting

[TOP/LEFT]/[TOP/RIGHT]/[BOTTOM/LEFT]/[BOTTOM/RIGHT]

- You can also change the waveform position to the upper left, upper right, bottom left or bottom right by performing one of the following operations while a waveform is displayed:
 - Rotating the jog dial
 - Sliding the waveform while touching it.

Fast Zoom



• Register “Fast Zoom” to a USER button. (→ 75)

You can use Fast Zoom when operating the zoom with the zoom lever. (→ 41)

EVF ON/OFF



• Register “EVF ON/OFF” to a USER button. (→ 75)

This forces the viewfinder to turn on/off.

• After the viewfinder turns on, if the eye sensor detects your eye when it is moved closer to the eye cup of the viewfinder the [EVF ON/OFF] setting will be canceled.

• When the [LCD/EVF OUTPUT] is set to [LCD], this item cannot be set. (→ 24)

Auto Iris Level



• Register “Auto Iris Level” to a USER button. (→ 75)

This enables/disables the Auto Iris Level.

• When this item is enabled, the [AUTO IRIS LEVEL EFFECT] setting is applied. (→ 60)

Zebra



• Register “Zebra” to a USER button. (→ 75)

Press USER button or touch USER button icon in the recording screen.

It will switch between the zebra display and the marker display every time the button is pressed.

Zebra 1 → Zebra 2* → Marker* → setting canceled

* It is not displayed when the [ZEBRA DETECT 2]/[MARKER] is set to [OFF]. (→ 182)

(When Zebra 1 is set)

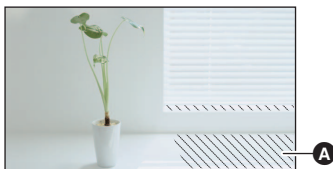

(When Marker is set)

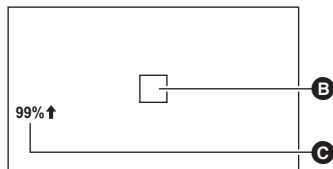

Zebra display:

Parts where white saturation (color saturation) is likely to occur (extremely brightly lit or shiny parts) are displayed with diagonal lines (zebra pattern **A**).

Marker display:

Displays the luminance level of the center of the screen (luminance display frame **B**) in %.

It makes the adjustment of the brightness of the object easier, by checking the luminance level of the object, when recording same object in different surroundings.

• Luminance level **C** is displayed between 0% and 99%. It will be displayed as 99% ↑ when it is over 99%.

• This function is not available in the following cases:

- When [WFM] is set to [ON] (→ 87, 166)
- During Freeze Frame (→ 81)

- You can record an image with little white saturation if you manually adjust the shutter speed or brightness not to display zebra pattern. (→ 59, 64)
- The zebra pattern does not appear on the images actually recorded.
- It is also possible to adjust the level of the zebra pattern to be displayed. (→ 182)
- It is also possible to change the [ZEBRA MODE] setting to change the display time for the zebra pattern display. (→ 166)

Optical Image Stabilizer



- Register “Optical Image Stabilizer” to a USER button. (→ 75)

This enables/disables the Image Stabilizer. (→ 42)

Scene File



- Register “Scene File” to a USER button. (→ 75)

You can save the scene number settings of [CUSTOMIZE SCENE] to the SD card or load them from the SD card to this unit.

■ Saving custom scene settings

- 1 Press USER button or touch USER button icon in the recording screen.
- 2 Touch [SAVE].
- 3 Touch the name of the scene file.
 - All scene number settings will be saved.
 - Up to 8 files can be saved.
 - If you have touched the name of the existing scene file, touch [YES] to overwrite it.
- 4 Touch [EXIT] to complete the setting.

■ Assigning saved scene files to custom scenes

- 1 Press USER button or touch USER button icon in the recording screen.
- 2 Touch [LOAD].
- 3 Touch the name of the scene file you want to load.
- 4 Touch the scene number to which you want to assign the scene file.
 - Settings of the scene number you have touched will be loaded, and then assigned to the corresponding scene number in [CUSTOMIZE SCENE].
 - If you touch [ALL], settings of all scene numbers will be loaded.
- 5 Touch [EXIT] to complete the setting.

-
- You can also access this function by selecting menu items.
[SCENE FILE] → [SCENE FILE] → [LOAD] or [SAVE]

Auto Rec



• Register “Auto Rec” to a USER button. (→ 75)

This enables/disables a function that controls recording performed with an external device (recorder, etc.) connected to the SDI OUT terminal.

1 Select the [SDI REMOTE] menu.

 : [OUTPUT SETUP] → [SDI REMOTE] → [ON]

2 Select the [REMOTE REC LINK] menu.

 : [OUTPUT SETUP] → [REMOTE REC LINK] → [OFF]

3 Press USER button or touch USER button icon in the recording screen.

- When **SDI** ● is displayed, signals will be transmitted, prompting the external device to start recording.
- To stop the recording being performed with the external device, press the applicable USER button or touch the applicable USER button icon again. When **SDI** ■ is displayed, signals will be transmitted, prompting the external device to stop the recording.

-
- When [HDMI TC OUTPUT] is set to [ON], you can also control recording performed with an external device connected to the HDMI OUT terminal.
 - It is not possible to control recording performed with an external device connected to the SDI OUT terminal in the following cases:
 - When [REC FORMAT] is set to [SA 480/59.94i] or [SA 576/50.00i] (→ 151)
 - When [RESOLUTION] is set to [DOWN CONV.] (→ 116)

AF area width adjustment



• Register “AF area width adjustment” to a USER button. (→ 75)

You can adjust the area width where Auto Focus works according to the size of the subject. (→ 47)

1 Press USER button or touch USER button icon in the recording screen.

- [AF-AREA] are displayed on the screen.

2 Rotate the jog dial to adjust the AF area frame.

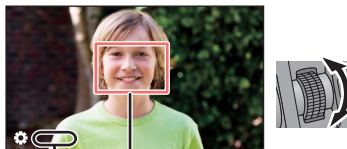

- A [AF AREA]
- B AF area frame

3 Push the jog dial to finish the adjustment.

- Press USER button or touch the USER button icon to cancel the setting.
- To adjust the AF area frame again, press the jog dial while the on-screen icon [⚙️ AF AREA] (yellow) is displayed, and repeat Steps 2–3.
- For information on on-screen icons, refer to 100.





This enables/disables Variable Frame Rate (VFR) Mode.

In Variable Frame Rate Mode, you can record quick or slow motion picture by changing the frame rate before recording.

Slow motion (overcrank recording)

Used in scenes such as climaxes, a slow motion effect creates a dramatic impression. Set a frame rate that provides more frames than the frame rate in [REC FORMAT] does.

Example: If you set [FHD 1080/23.98p 50M] to 48fps and record a motion picture, a slow motion effect of 1/2 can be gained.

Quick motion (undercrank recording)

A fast motion effect is used in scenes showing the flow of clouds, people standing in the middle of crowds, etc. Set a frame rate that provides less frames than the frame rate in [REC FORMAT] does.

Example: If you set [FHD 1080/23.98p 50M] to 12 fps and record a motion picture, a quick motion effect of 2× can be gained.

- Register “VFR mode” to a USER button. (→ 75)
- Set [OUTPUT BITS] to [4:2:2(8bit)]. (→ 31)
- Make the [REC MODE] and [REC FORMAT] settings. (→ 150, 151)
- Variable Frame Rate Mode is available for the following [REC MODE] and [REC FORMAT] settings:*
- * When the size for [REC FORMAT] is set to FHD (1920×1080) and a frame rate other than 59.94i and 50.00i is set for [REC FORMAT], a [REC FORMAT] setting with a bit rate of 50 Mbps will be selected automatically.

System frequency setting	Recording mode	Recording format
59.94Hz	MOV, MP4	FHD 1080/59.94p 50M, FHD 1080/29.97p 50M, FHD 1080/23.98p 50M
50.00Hz		FHD 1080/50.00p 50M, FHD 1080/25.00p 50M

1 Press USER button or touch USER button icon in the recording screen.

- [VFR] will be displayed.
- The frame rate display will change.

(Example)

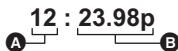

- Ⓐ Frame Rate (fps)
- Ⓑ Frame rate in [REC FORMAT]

- [ALC] / [AREC] will be displayed. Audio is not recorded during recording.

2 Rotate the jog dial to change the frame rate.

- You can set a frame rate between 2 and 120. Some frame rates cannot be set depending on the [REC FORMAT] setting.
- Push the jog dial to set the frame rate. If you start recording before pushing the jog dial, the setting will not be applied.

3 Press the recording start/stop button to start recording.

- When recording in Variable Frame Rate Mode for the first time since you turned on this unit, a message is displayed, informing you that audio cannot be recorded.*
- * Audio is recorded when the number of frames for the frame rate in [REC FORMAT] and the number of frames for Variable Frame Rate Mode are the same.
- The frame rate cannot be changed during recording.

4 Press the recording start/stop button again to stop recording.

- To cancel Variable Frame Rate Mode, press USER button, or touch USER button icon.

■ Frame rates and their effects

Quick motion (undercrank) or slow motion (overcrank) recording is possible with the following frame rate settings:

- When you set the frame rate to 100 fps or 120 fps, the angle of view will change. (The color of the frame rate value will change to blue.)

[REC FORMAT]	Available frame rates		
[FHD 1080/59.94p 50M]	2 fps to 58 fps	60 fps	62 fps to 120 fps
[FHD 1080/29.97p 50M]	2 fps to 28 fps	30 fps	32 fps to 120 fps
[FHD 1080/23.98p 50M]	2 fps to 22 fps	24 fps	26 fps to 120 fps
[FHD 1080/50.00p 50M]	2 fps to 48 fps	50 fps	52 fps to 120 fps
[FHD 1080/25.00p 50M]	2 fps to 23 fps	25 fps	27 fps to 120 fps
Effect on playback	Quick motion (The smaller the value is, the faster the playback becomes.)	Normal	Slow motion (The larger the value is, the slower the playback becomes.)
Audio recording	No	Yes	No

■ Frame rates during actual recording

There is a slight difference between each frame rate that can be selected and the actual frame rate at which recording is performed.

Recording will be performed at one of the frame rates below.

- Top row: frame rates that can be selected (fps); bottom row: frame rates during actual recording (fps)

(When [SYSTEM FREQ] is set to [59.94Hz])

2	12	15	18	20	22	24	26	28	30
2.00	11.99	14.99	17.98	19.98	22.48	23.98	25.69	27.97	29.97

32	34	36	40	45	48	55	58	60	62
31.97	33.72	35.96	39.96	44.96	47.95	54.95	57.63	59.94	62.44

65	72	75	84	90	96	120
64.94	71.93	74.93	83.92	89.91	95.90	119.88

(When [SYSTEM FREQ] is set to [50.00Hz])

2	12	21	23	25	27	30	33	37	45
2.08	12.50	20.83	23.08	25.00	27.50	30.00	33.33	37.50	45.00

48	50	52	55	62	75	100	120
47.50	50.00	52.50	55.00	62.50	75.00	100.00	120.00

- You can also enable/disable Variable Frame Rate Mode or change the frame rate using the menu.
 - [VFR MODE] (→ 140)
 - [FRAME RATE] (→ 140)
 - Variable Frame Rate Mode is set to [OFF] in following cases:
 - When the [REC MODE] or [REC FORMAT] setting is changed to a setting that does not support Variable Frame Rate Mode
 - When the [REC FORMAT] setting is changed to a setting with a different frame rate
 - This function is not available in the following cases:
 - When you set [OUTPUT BITS] to [4:2:2(10bit)]
 - When [2 SLOTS FUNC.] is set to [DUAL CODEC] (→ 170)
 - The following functions are canceled:
 - Flash band compensation (→ 86, 149)
 - Relay recording (→ 170)
 - Background recording (→ 171)
 - Interval Recording (→ 173)
 - PRE-REC (→ 86, 174)
 - Hybrid Optical Image Stabilizer (→ 42)
 - Area Mode (→ 82)
 - Focus Transition (→ 52)
 - Digital Zoom (→ 93)
 - Infrared Recording mode (→ 84, 175)
 - Custom AF function (→ 46)
 - i.Zoom (→ 41)
 - [BLACK FADE] and [WHITE FADE] are disabled. (→ 79)
 - Still picture recording cannot be used.
 - Even if you press the recording start/stop button as soon as recording has started, it may take some time until the recording stops.
 - The screen may momentarily black out when the frame rate is changed in Step 2.
 - When using Variable Frame Rate (VFR) Mode with a low frame rate setting, this unit may not be able to keep up with changes in the image. In such a case, set the iris, focus and White Balance mode to manual settings.
 - The maximum continuous recordable time for one scene in Variable Frame Rate Mode varies depending on the set frame rate. Recording stops when a certain time has elapsed since the start of the recording, and restarts automatically a few seconds later.
 - With undercrank recording: 10 hours
 - When overcrank recording with the same frame rate as the frame rate in [REC FORMAT]: 10 hours
 - With overcrank recording, the recordable time becomes shorter than 10 hours depending on the ratio between the frame rate for [REC FORMAT] and variable frame rate setting.
- Example: When [REC FORMAT] is set to [FHD 1080/59.94p 50M]

Variable frame rate setting	Maximum continuous recordable time for one scene
2 fps	10 h
60 fps	
120 fps	5 h

- “h” is an abbreviation for hour.

Digital Zoom



- Register “Digital Zoom” to a **USER button**. (→ 75)
 - Set [OUTPUT BITS] to [4:2:2(8bit)]. (→ 31)
- Press **USER button** or touch **USER button icon** in the recording screen.
- When [DIGITAL ZOOM] is set to [×2], [×5] or [×10], Digital Zoom will be turned on/off each time you press the button.

- When [DIGITAL ZOOM] is set to [TOGGLE], the zoom magnification will change each time you press the button.

2× → 5× → 10× → Setting canceled

■ To change the zoom magnification of Digital Zoom

The zoom magnification of Digital Zoom varies depending on the [DIGITAL ZOOM] setting.

 : [SW SETUP] → [DIGITAL ZOOM] → desired setting

[×2]:	Sets the zoom magnification to 2×.
[×5]:	Sets the zoom magnification to 5×.
[×10]:	Sets the zoom magnification to 10×.
[TOGGLE]:	Changes the zoom magnification each time you press the applicable USER button.

- When using Digital Zoom, the larger you set the zoom magnification, the lower the picture quality becomes.
- Digital Zoom is not possible in following cases:
 - When [OUTPUT BITS] is set to [4:2:2(10bit)]
 - During Freeze Frame (→ 81)
 - When using Area Mode (→ 82)
 - In Variable Frame Rate Mode (→ 91)
 - During the Interval Recording (→ 173)
- Digital zoom is canceled in following cases:
 - If you turn the unit off
 - If you press the THUMBNAIL button
 - When [USB MODE SELECT] is set to [DEVICE] and this unit is connected to a PC. (→ 123)

i.Zoom

- Register “i.Zoom” to a USER button. (→ 75)

You can enable/disable i.Zoom.

Log View Assist

When [V-Log L MODE] is selected, you can temporarily display images in REC.709 color space.

- Register “Log View Assist” to a USER button. (→ 75)
- Set [V-Log L MODE] to [ON]. (→ 149)

Press USER button or touch USER button icon in the recording screen.

- Assist appears on the screen.
- To cancel, press the USER button or touch the USER button icon again.

- Log View Assist is canceled in the following cases:
 - When starting motion picture recording
 - When PRE-REC is set (→ 86, 174)
 - When Background recording (→ 171)
- If you start recording during Log View Assist, recording will start after it is canceled.

LCD/EVF Output



- Register “LCD/EVF Output” to a USER button. (→ 75)

This changes how to turn on/off the LCD monitor and Viewfinder. (→ 24)

Histogram



- Register “Histogram” to a USER button. (→ 75)

A graph with brightness as horizontal axis and number of pixels at that brightness as vertical axis is displayed. It is possible to determine the exposure of the whole image by looking at the distribution in the graph.

■ To move a histogram

You can move a histogram by touching and holding the histogram display **A**. Slide the display while touching it to move it to the desired display location.

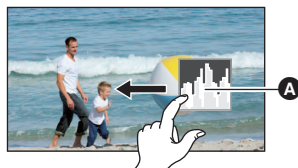

- This function is not available in the following cases:
 - When [REC FORMAT] is set to [UHD 2160/59.94p 150M] or [UHD 2160/50.00p 150M] (→ 151)
 - During Freeze Frame (→ 81)
- To adjust the brightness, refer to page 59.

Push Auto



- Register “Push Auto” to a USER button. (→ 75)

You can use the USER button as the PUSH AUTO button.

- Pressing the USER button or touching the USER button icon in Manual Focus Mode allows you to use One Push AF.
- Pressing and holding the USER button or touching and holding the USER button icon in Manual Focus Mode allows you to use Push AF.

Slot Selection



- Register “Slot Selection” to a USER button. (→ 75)

You can change the card slot used for motion picture recording or the playback media.

- You can change the setting in the following situations:
 - While recording is paused in Recording Mode
 - While a thumbnail screen is displayed in Playback Mode
 - While the list by date is selected

Auto White Balance



- Register “Auto White Balance” to a USER button. (→ 75)

You can change the White Balance mode or use Auto White Balance or Auto Black Balance.

Menu



- Register “Menu” to a USER button. (→ 75)

The menu can be displayed.

Useful functions

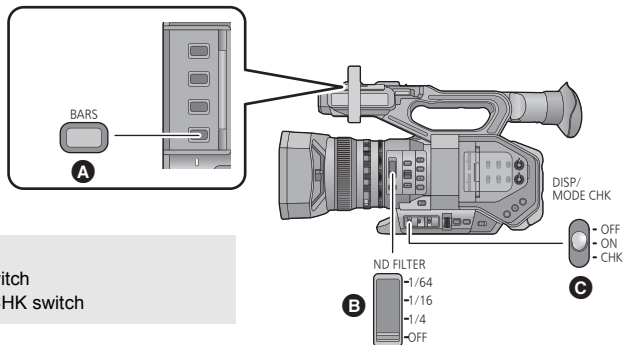

- A** BARS button
- B** ND FILTER switch
- C** DISP/MODE CHK switch

Color Bar Screen

BARS button

Press the BARS button to output a color bar screen to an external monitor so you can adjust them.

- To cancel, press the BARS button again.
- It will be canceled when the unit is turned off.
- While the color bar is displayed, a test tone will be output from the headphone terminal, HDMI terminal, SDI OUT terminal and AUDIO OUT terminal. It will not be output from the speaker of this unit.
- Different color bars are displayed depending on the [BARS TYPE] setting. (→ 167)
- The frequency of a test tone that is output when color bars are displayed differs depending on the setting of the following items:
 - [SYSTEM FREQ] (→ 150)
 - The frame rate in [REC FORMAT] or [OUTPUT FORMAT] (→ 151, 157)

System Frequency setting	Frame rates	Test tone frequency
59.94Hz	All frame rates	1 kHz
50.00Hz	24.00p	
	50.00p/50.00i/25.00p	997 Hz

- The test tone volume differs depending on the [TEST TONE] setting. (→ 181)
- You can record color bars as motion pictures, but not as still pictures.
- If you press the BARS button while recording color bars as a motion picture, you can stop displaying the color bars. To display them again, stop the recording and press the BARS button.

ND filter

Using the ND filter switch, you can switch the built-in optical ND filter setting. (The filter adjusts the amount of light.)

- Use this function when recording a bright subject outdoors under a clear sky that causes the screen to look white.

Slide the ND filter switch.

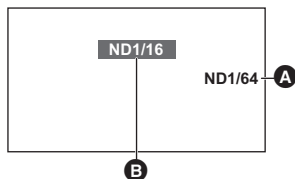

- A** ND filter setting
- B** Recommended ND filter setting

1/64:	Reduces the amount of light to 1/64.
1/16:	Reduces the amount of light to 1/16.
1/4:	Reduces the amount of light to 1/4.
OFF:	Does not use the ND filter.

- If the selected setting 1/64, 1/16 or 1/4 does not match an ND filter setting recommended by this unit, the recommended setting will be displayed on the screen, blink for approximately 5 seconds and disappear.

- A recommend ND filter setting may not be displayed correctly in scenes that are too dark.

Switching the screen indications/mode information display

DISP/MODE CHK switch

When the DISP/MODE CHK switch is set to OFF, all screen displays disappear, except for the counter display, time stamp display*, zebra pattern display, marker display, and safety zone display. (→ 194)

- * When [DATE/TIME] is set to [TIME], [DATE], or [DATE&TIME]
- To cancel the setting, set the DISP/MODE CHK switch to ON.

■ To display the Mode Information

Each time you set the DISP/MODE CHK switch from ON to CHK, the mode information display switches in the following order:

Mode information display1 → Mode information display2 → Mode information display3 → Normal display

Mode information display1:	Displays the list of functions assigned to the USER buttons (USER1 to 8 and AWB).
Mode information display2:	Displays the settings assigned to the GAIN switch ([GAIN L]/[GAIN M]/[GAIN H]), the White Balance mode settings assigned to the WHITE BAL switch ([WHITE BAL A]/[WHITE BAL B]/[WHITE BAL PRST]), and the setting status of the White Balance modes [Ach] and [Bch] ([AWB A]/[AWB B]).
Mode information display3:	Displays the settings for [OUTPUT SEL], [OUTPUT BITS], [SDI REMOTE], [REMOTE REC LINK], [HDMI TC OUTPUT], [CAMERA NUMBER], [SUB REC BUTTON] and [SUB ZOOM].

Recording



Using Operation Icons

You can use convenient functions just by the easy operation of touching the screen.

1 Touch the LCD monitor in the recording screen.

- The operation icons are displayed.

2 Touch an operation icon.

- The following function is available. Refer to the respective pages for the operation.



etc.	Customize Scene (→ 139)
etc.	USER Button Icon (→ 75)
	i.Zoom Button Icon (→ 41)*

* It is not displayed when [i.Zoom] is set to [OFF].

- If you touch the screen while an operation icon is being displayed or do not touch the icon for a certain period, it will disappear. To display again, touch the screen.

Using of jog dial

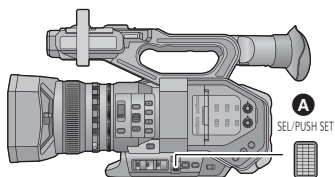

A Jog dial

Selecting/setting items

You can select and set menu items (→ 30), etc. using the jog dial.

1 Rotate the jog dial on the menu screen, etc., to move the cursor.

- The selected item will be displayed in yellow.

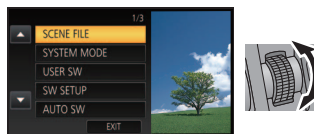

2 Push the jog dial to set.



Menu operations for setting a value

When a menu that lets you set a value is displayed, select the value display before adjusting the setting.

- You cannot select ▲/▼/◀/▶ with the jog dial when a screen that lets you adjust a value is displayed.

(Example: When adjusting the brightness for [LCD SET])

1 Rotate the jog dial to move the cursor to the value display A.

- Push the jog dial to select the value display.

2 Rotate the jog dial to adjust the setting.

- Pushing the jog dial will set the value you have selected.











- The jog dial also allows you to select/set operation icons, thumbnails, etc.
- Parts that are finger-touch sensitive can be operated with the jog dial. (Excluding some functions)



Using the multi manual function

You can select the following functions and adjust their settings using the jog dial.
You can also switch between the functions and adjust their settings.

(When the recording screen is displayed)

On-screen icons	Functions	Settings
 GAIN	Gain adjustment (→ 61)	Adjusts the gain value.
 VAR	VAR adjustment (→ 58)	Adjusts the VAR setting of the White Balance.
 AF AREA	AF Area Range Adjustment (→ 47)	Adjusts the size of the AF area frame.
 VFR	Variable Frame Rate (→ 91)	Changes the frame rate for Variable Frame Rate Mode.
 SHUTTER	Shutter speed (→ 64)	Adjusts the shutter speed.
 AREA	Area Mode (→ 82)	Changes the area frame setting.
 ASSIST	Focus Assist (→ 48)	Changes the magnification level of the magnified display
 VOLUME	Headphone Volume Adjustment (→ 101)	Adjusts the headphone volume.
 ICONS	Allows you to display/select operation icons on the recording screen.	—

(When the playback screen is displayed)

On-screen icons	Functions	Settings
 VOLUME	Volume adjustment (→ 104)	Adjusts the speaker and headphone volume during motion picture playback.
 ICONS	Allows you to display/select operation icons on the playback screen.	—

To change the function you adjust

1 Change settings in advance so that you can select more than two functions.

- Change settings as follows:

Functions	Settings to be changed in advance
Gain adjustment	Switch to Manual Mode. (→ 36)
VAR adjustment	Set the WHITE BAL switch to PRST and press the USER button to which [AWB] is registered to set the White Balance mode to [VAR]. (→ 55)
AF Area Range adjustment	Press the applicable USER button to enable [AF AREA WIDTH] or select menu items to set [AF AREA WIDTH] to [SET]. (→ 47, 90)
Variable Frame Rate	Press the applicable USER button to enable [VFR MODE] or select menu items to set [VFR MODE] to [ON]. (→ 91, 140)
Shutter speed	Press the SHUTTER button to enable Manual Shutter Mode. (→ 64)
Area Mode	Press the applicable USER button to enable Area Mode. (→ 82)
Focus Assist	Set [FOCUS ASSIST 1] or [FOCUS ASSIST 2] to [EXPAND] or [BOTH]* and press the FOCUS ASSIST button or the applicable USER button to set Focus Assist to ON. (→ 48) * This item is only set in [FOCUS ASSIST 1].
Headphone Volume Adjustment	Connect headphones to this unit.

- The on-screen icon for the selected function is displayed in white. (Function Execution Mode)
If you have selected [⚙️ ICONS], you can rotate the jog dial to select an operation icon.

2 Push the jog dial.

- The on-screen icon turns yellow. (Function Selection Mode)

3 Rotate the jog dial to select the function you want to adjust, and press the jog dial to set the selection.

- The on-screen icon for the selected function turns white. (Function Execution Mode)
- You can rotate the jog dial to adjust the setting of the selected function.

■ Headphone Volume Adjustment

Adjust the volume of the headphone while recording.

- Set [VOLUME] to [ON]. (→ 181)

1 Connect headphones to the headphone terminal.

2 Rotate the jog dial to adjust the volume.

- Actual volume to be recorded does not change.

3 Push the jog dial to finish the adjustment.

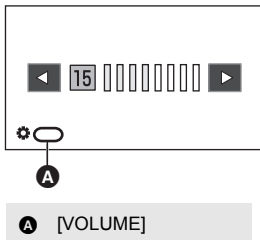

- You can also adjust the volume by touching [◀/▶] in Step 2. Not performing touch operations after the adjustment allows you to exit the setting.



Motion picture/Still picture playback

- 1 Set this unit to playback mode. (→ 23)
- 2 Touch the play mode select icon **A**.

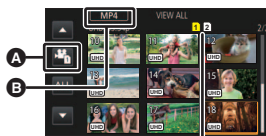

Media display

The selected media is displayed in yellow.

- 3 Select the media **C** you wish to play back.



- 4 (To set this unit to Motion Picture Playback Mode)
Touch the desired recording mode **D** and recording format **E** for playback.

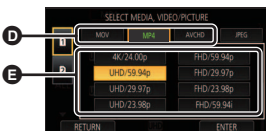



- Recording mode options with recorded scenes are displayed in green.
- The available recording format options differ depending on [SYSTEM FREQ] (→ 188) or the recording mode option you have touched.
- Touch [ENTER].
- A recording mode icon **B** will be displayed on the thumbnail display. (MOV) / (MP4) / (AVCHD)
- (If you have touched a recording mode option [MOV] or [MP4])
After you have touched a recording format option, one of the following icons will be displayed on each thumbnail. The icon to be displayed differs depending on the size of recording format.
 - **4K** : Scenes recorded in 4K (4096×2160)
 - **UHD** : Scenes recorded in UHD (3840×2160)
 - **FHD** : Scenes recorded in FHD (1920×1080)
 - **DUS9** : Scenes recorded as sub recordings with [DUAL CODEC REC] set to [FHD 50Mbps] (→ 170, 172)
 - **DUB** : Scenes recorded as sub recordings with [DUAL CODEC REC] set to [FHD 8Mbps] (→ 170, 172)
- (If you have touched the recording mode option [AVCHD])
After you have touched a recording format option, one of the following icons will be displayed on each thumbnail.
 - **PS** : Scenes recorded in [PS 1080/59.94p]/[PS 1080/50.00p]
 - **PH** : Scenes recorded in [PH 1080/59.94i]/[PH 1080/23.98p]/[PH 1080/50.00i]
 - **HA** : Scenes recorded in [HA 1080/59.94i]/[HA 1080/50.00i]
 - **HE** : Scenes recorded in [HE 1080/59.94i]/[HE 1080/50.00i]
 - **PM** : Scenes recorded in [PM 720/59.94p]/[PM 720/50.00p]
 - **SA** : Scenes recorded in [SA 480/59.94i]/[SA 576/50.00i]

(To set this unit to Still Picture Playback Mode)

Touch the still picture (JPEG) .



5 Touch the scene or the still picture to be played back.

- Next (Previous) page can be displayed by touching  / .
- You can change the playback media by pressing the USER button to which [SLOT SEL] is registered. (→ 75)

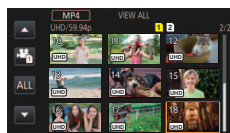











6 Select the playback operation by touching the operation icon.





G Operation icon

- If you touch the screen while an operation icon is being displayed or do not touch the icon for a certain period, it will disappear. To display again, touch the screen.

Motion picture playback	Still picture playback
<p>: Playback/Pause</p> <p>: Fast rewind playback*</p> <p>: Fast forward playback*</p> <p>: Stops the playback and shows the thumbnails.</p>	<p>: Slide show (playback of the still pictures in numerical order) start/pause.</p> <p>: Plays back the previous picture.</p> <p>: Plays back the next picture.</p> <p>: Stops the playback and shows the thumbnails.</p>

* When touched twice, the fast forward/fast rewind speed increases. (Screen display will change to  /  .)

Change the thumbnail display

While the thumbnail is displayed, the thumbnail display changes in the following order if the zoom lever or the sub zoom lever is operated to  side or  side.

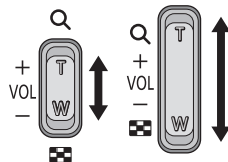

( side)

( side)

20 scenes ↔ 9 scenes ↔ 1 scene ↔ Scene information display*

* Detailed information of the scene is displayed when playing back motion pictures. Following information is displayed.

START TC, START UB, and DURATION are displayed only for AVCHD scenes.

- START TC
- START UB
- DATE
- TIME ZONE
- DURATION
- REC MODE
- FORMAT

- If you press the THUMBNAIL button to switch between Recording Mode and Playback Mode, the thumbnails of 9 scenes will be displayed.
- By displaying in 1 scene, recording date and time are displayed when playing back motion pictures, and recording date and file number when playing back still pictures.

Speaker/Headphone volume adjustment

Operate the volume lever, sub zoom lever or jog dial to adjust the speaker/headphone volume during Motion Picture Playback Mode.

Adjusting the volume with the volume lever/sub zoom lever

Towards “+”:

Increases the volume

Towards “-”:

Decreases the volume

A [VOLUME]

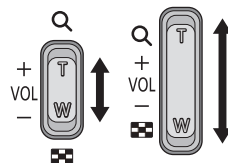
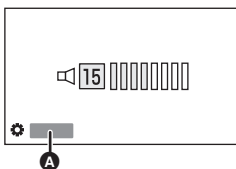

Adjusting the volume with the jog dial

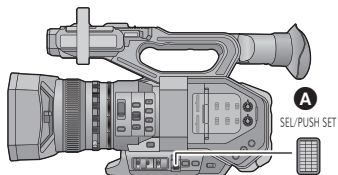

A Jog dial

- 1 Push the jog dial while [ VOLUME] is displayed.



2 Rotate the jog dial to adjust the volume.

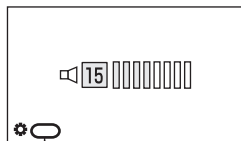

B [VOLUME]

3 Push the jog dial to finish the adjustment.

- Sound will be heard only during normal motion picture playback.
- If pause play is continued for 5 minutes, the screen returns to the thumbnails.
- In the following cases, when you select the desired recording format for playback, this unit will be restarted to switch the system frequency:
 - When you have switched recording format from [4K/24.00p] to a different option.
 - When you have switched recording format from an option other than [4K/24.00p] to [4K/24.00p]
- If you set recording mode to [AVCHD] and recording format to [ALL AVCHD] and play back a scene, the screen may turn dark momentarily when it switches to another scene.

Motion picture compatibility









- This unit is based on AVCHD Progressive/AVCHD.
- Even if the devices used have compatible standards, when playback of video recorded using another device is performed using this device, or when video recorded using this device is played back in another device, playback may not proceed normally, or may not be possible. (Please check compatibility in the instruction manual of your device.)
- Motion pictures recorded with devices other than this unit are not supported by this unit.

Still picture compatibility

- This unit is compliant with the unified standard DCF (Design rule for Camera File system) established by JEITA (Japan Electronics and Information Technology Industries Association).
- The file format of still pictures supported by this unit is JPEG. (Not all JPEG formatted files will be played back.)
- This unit may degrade or not play back still pictures recorded or created on other products and other products may degrade or not play back still pictures recorded on this unit.
- Depending on the playback device, still pictures may be played back with picture sizes different from the ones with which they were recorded.

Motion picture playback using operation icon

For details on the basic playback operations, refer to page 102.

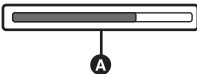
Playback operation	Playback display	Operating steps
Skip playback (to the start of a scene)	During Playback 	Touch the LCD monitor and slide from right to left (from left to right) during playback.
Slow-motion Playback	During Pause 	<p>With the playback paused, continue touching .</p> <p>( is for slow rewind playback.) Playback is slow while touching.</p> <ul style="list-style-type: none"> Normal playback is restored when you touch . When AVCHD scenes are played back in reverse slow-motion, they will be shown continuously at approximately 2/3rd the speed of normal playback (at 0.5 second intervals). MOV/MP4 scenes are played back as follows: <ul style="list-style-type: none"> Scenes recorded with [REC FORMAT] set to [FHD 1080/59.94p ^{ALL-I} 200M], [FHD 1080/29.97p ^{ALL-I} 200M], [FHD 1080/50.00p ^{ALL-I} 200M], [FHD 1080/25.00p ^{ALL-I} 200M], [FHD 1080/23.98p ^{ALL-I} 200M]: Reverse slow-motion playback at 1 second intervals Scenes recorded with [REC FORMAT] set to an option other than the above: Reverse slow-motion playback at 0.5 second intervals
Frame-by-frame Playback	During Pause 	<p>With the playback paused, touch .</p> <p>(Touch  to advance the frames one at a time in the reverse direction.)</p> <ul style="list-style-type: none"> Normal playback is restored when you touch . Frames are played back at 0.5 second intervals during reverse frames-by-frame playback.
Direct playback	During Playback 	<p>Touch the direct playback bar A or slide it while touching.</p> <ul style="list-style-type: none"> The playback pauses temporarily and skips to the position touched or slid to while touching. Playback will start by releasing your touching or sliding finger.



Useful functions

Creating still picture from motion picture

You can save a frame of a recorded motion picture as a still picture. The picture size with which a still picture will be recorded differs depending on the picture size of [REC FORMAT] with which the motion picture was recorded.

Recording format	Aspect ratio	Picture size
[REC FORMAT] setting with a size of 4K (4096×2160)	17:9	4096×2160
[REC FORMAT] setting with a size of UHD (3840×2160)	16:9	3840×2160
[REC FORMAT] setting with a size of FHD (1920×1080)		1920×1080
[PS 1080/59.94p]/[PS 1080/50.00p]/ [PH 1080/59.94i]/[PH 1080/23.98p]/ [PH 1080/50.00i]/ [HA 1080/59.94i]/[HA 1080/50.00i]/ [HE 1080/59.94i]/[HE 1080/50.00i]		
[PM 720/59.94p]/[PM 720/50.00p]		1280×720

While playing back a motion picture, touch the at the scene you want to save it as a still picture.

- If you register [CAPTURE] to any of the USER buttons 1–8 or AWB button, you can capture a still picture by pressing the USER button. For information on how to register functions to the USER buttons, refer to page 75.
- It is convenient to use Pause, Slow-motion Playback and Frame-by-frame Playback.
- Date the motion picture was recorded will be registered as date of the still picture.
- Quality will be different from the normal still picture.



- Please refer to page 217 about approximate number of recordable pictures.

Repeat Playback

Playback of the first scene starts after playback of the last scene finishes.

Select the menu.

 : [VIDEO SETUP] → [REPEAT PLAY] → [ON]

The  indication appears on the full screen views.

- All the scenes displayed in the thumbnail will be repeatedly played back.

-
- Repeat Playback cannot be used for the slide show playback of the still pictures. (→ [103](#))

Resuming the previous playback

If playback of a scene was stopped halfway, the playback can be resumed from where it was stopped.

Select the menu.

 : [VIDEO SETUP] → [RESUME PLAY] → [ON]

If playback of a motion picture is stopped,  appears on the thumbnail view of the stopped scene.

-
- The memorized resume position is canceled if you turn off the unit or press the THUMBNAIL button. (The setting of [RESUME PLAY] does not change.)

Playing back scenes or still pictures by date

The scenes or still pictures recorded on the same day can be played back in succession.

1 Touch the date select icon.

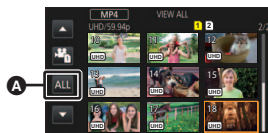

A Date select icon

2 Touch the playback date.

- The scenes or still pictures recorded on the date selected are displayed as thumbnails.

3 Touch the scenes or still picture to be played back.

- If you press the THUMBNAIL button to switch between Recording Mode and Playback Mode, the thumbnails of all scenes will be displayed.
- In cases such as those described below, scenes and still pictures are grouped separately on the date list, and -1, -2... may be added after the date:
 - When the number of scenes exceeds 99
 - When the number of still pictures exceeds 999
 - When you change the [REC FORMAT] setting (→ 151)
 - When you set [REC MODE] to [AVCHD] and set Interval Recording to an option other than [OFF] (→ 173)
 - When you set [REC MODE] to [MOV] or [MP4] and change the system frequency (→ 150)
 - When [NUMBER RESET] is performed (→ 189)
- Scenes recorded with the following [REC FORMAT] settings are grouped separately on the date list. A recording format icon will be displayed next to the date.

Recording format	Icon to be displayed
[REC FORMAT] setting with a size of 4K (4096×2160)	4K
[REC FORMAT] setting with a size of UHD (3840×2160)	UHD
[REC FORMAT] setting with a size of FHD (1920×1080)	FHD
Scenes recorded as sub recordings with [DUAL CODEC REC] set to [FHD 50Mbps] (→ 170, 172)	DU50
Scenes recorded as sub recordings with [DUAL CODEC REC] set to [FHD 8Mbps] (→ 170, 172)	DU8
[PS 1080/59.94p]/[PS 1080/50.00p]	PS
[PH 1080/59.94i]/[PH 1080/23.98p]/[PH 1080/50.00i]	PH
[HA 1080/59.94i]/[HA 1080/50.00i]	HA
[HE 1080/59.94i]/[HE 1080/50.00i]	HE
[PM 720/59.94p]/[PM 720/50.00p]	PM
[SA 480/59.94i]/[SA 576/50.00i]	SA

-  is displayed after the date in the list by date for the still pictures created from the motion picture. (→ 107)

Deleting scenes/still pictures

Deleted scenes/still pictures cannot be restored, so perform appropriate confirmation of the contents before proceeding with deletion.

- Press the THUMBNAIL button to switch this unit to the Playback Mode. (→ 23)
- To delete the scene or still picture being played back

Touch while scenes or still pictures to be deleted are being played back.



■ To delete scenes or still pictures from the thumbnail display

- Switch to the thumbnail display of the scenes or still pictures to delete. (→ 102)

1 Select the menu.

: [VIDEO SETUP] or [PICT. SETUP] → [DELETE] → desired setting

[ALL SCENES]:

All the scenes or still pictures displayed as thumbnails can be deleted.

(When playing back scenes or still pictures by date, all scenes or still pictures of the selected date will be deleted.)

[MULTI]:

Multiple scenes or still pictures can be selected and deleted.

[SINGLE]:

Single scene or still picture can be selected and deleted.

- Protected scenes/still pictures cannot be deleted.

2 (When [MULTI] is selected in Step 1)

Touch the scene/still picture to be deleted.

- When touched, the scene/still picture is selected and the indication appears on the thumbnail. Touch the scene/still picture again to cancel the operation.
- Up to 99 scenes can be selected to be deleted.

(When [SINGLE] is selected in Step 1)

Touch the scene/still picture to be deleted.

3 (When [MULTI] is selected in Step 1)

Touch [Delete].

- To continuously delete other scenes/still pictures, repeat Steps 2-3.

When you stop deleting halfway:

Touch [CANCEL] or press MENU button while deleting.

- The scenes or still pictures that have already been deleted when the deletion is canceled cannot be restored.

To complete editing:

Touch [Return] or press MENU button.

-
- Scenes/still pictures that cannot be played back (the thumbnails are displayed as ) cannot be deleted.
 - In case of [ALL SCENES], the deletion may take time if there are many scenes or still pictures.
 - If you delete scenes recorded on other products or still pictures conforming to DCF standard with this unit, all the data related to the scenes/still pictures may be deleted.
 - When still pictures recorded on an SD card by other products are deleted, a still picture (other than JPEG) that cannot be played back on this unit, may be erased.

Protecting scenes/still pictures



Scenes/still pictures can be protected so that they are not deleted by mistake.

(Even if you protect some scenes/still pictures, formatting the SD card will delete them.)

- Press the THUMBNAIL button to switch this unit to the Playback Mode. (→ 23)

1 Select the menu.

 : [VIDEO SETUP] or [PICT. SETUP] → [SCENE PROTECT]

2 Touch the scene/still picture to be protected.

- When touched, the scene/still picture is selected and the  indication appears on the thumbnail. Touch the scene/still picture again to cancel the operation.
- Touch [Return] to complete the settings.

Copying between SD cards

Motion pictures or still pictures recorded with this unit can be copied between SD Cards inserted in this unit.

- Copying is not possible if the type of the source SD card (SDHC Memory Card/SDXC Memory Card) is different from that of the target SD card.

■ Check the used space of the copy destination

It is possible to check the used space of the SD Card by [MEDIA STATUS]. (→ 187)

- By displaying in 1 scene, recording date and time can be checked when playing back motion pictures, and recording date and file number when playing back still pictures.
- Depending on the media condition, some remaining capacity of the SD Card may not be used.

Copying

1 Press the THUMBNAIL button to switch this unit to the Playback Mode.

- Use a sufficiently charged battery or the AC adaptor.

2 Select the menu.

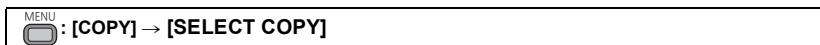

- [→]: Copies from card 1 to card 2
- [→]: Copies from card 2 to card 1
- [→]*: Copies from card 1 to an external media device
- [→]*: Copies from card 2 to an external media device

* Displayed only when the external media is connected. (→ 126)

3 Touch desired items following the screen display.

- It will return to the previous step by touching [Return].
- (When [SELECT SCENES] is selected)
When touched, the scene/still picture is selected and the indication appears on the thumbnail. Touch the scene/still picture again to cancel the operation.
- (When [SELECT DATE] is selected)
When touched, the date is selected and surrounded by red. Touch the date again to cancel the operation.
- Up to 99 scenes/still pictures or 99 dates can be set in succession.

4 Touch [EXIT] when the copy complete message is displayed.

- The thumbnail view of the copy destination is indicated.

When you stop copying halfway

Touch [CANCEL] while copying.

If you will delete the motion pictures or still pictures after copying is complete, be sure to play back the motion pictures or still pictures to check that they have been copied to correctly before deleting.

- Depending on the following conditions, the time it takes for copying may be longer.
 - The number of recorded scenes is large.
- If some motion pictures or still pictures have already been recorded to the copy destination, then the same date may be assigned or images may not display by date when the list by date is selected.
- Motion pictures that have been recorded on another device may not be copied. Data recorded on a PC cannot be copied.
- The settings for the copied motion pictures and still pictures will be cleared if the protected motion pictures or still pictures are copied.
- The order in which the scenes or still pictures were copied cannot be changed.

Connecting Headphones, a Remote Control or an External Monitor

Headphones

You can connect headphones (commercially-available) to the headphone output jack (3.5 mm (0.14 ") diameter stereo mini jack).

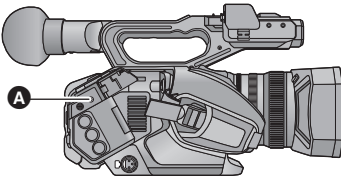

A Headphone output jack

- Sound is not output from the speaker when headphones are connected.

Remote control



You can connect a remote control (commercially-available) to either of the CAM REMOTE terminals (FOCUS IRIS or ZOOM S/S).

- Connecting a remote control to the FOCUS IRIS terminal (3.5 mm (0.14 ") diameter mini jack) allows you to remotely control the focus and iris.
- Connecting a remote control to the ZOOM S/S terminal (2.5 mm (0.1 ") diameter super-mini jack) allows you to remotely control the zoom and start/stop recording.

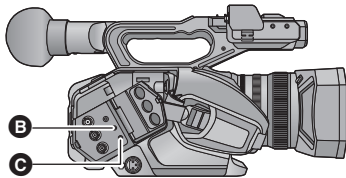

B FOCUS IRIS terminal
C ZOOM S/S terminal

- Do not connect any device other than a remote control to the CAM REMOTE terminals. Doing so may change the image brightness or cause the image to be out of focus.

(When a remote control is connected to the FOCUS IRIS terminal)

- Priority for iris adjustment is given to the remote control. It is not possible to adjust the iris with the iris ring of this unit.
- If you switch to Auto Mode when [A.IRIS] is set to [ON], the remote control cannot be used.

External monitor

You can connect this unit to an external monitor as shown in the figure below.

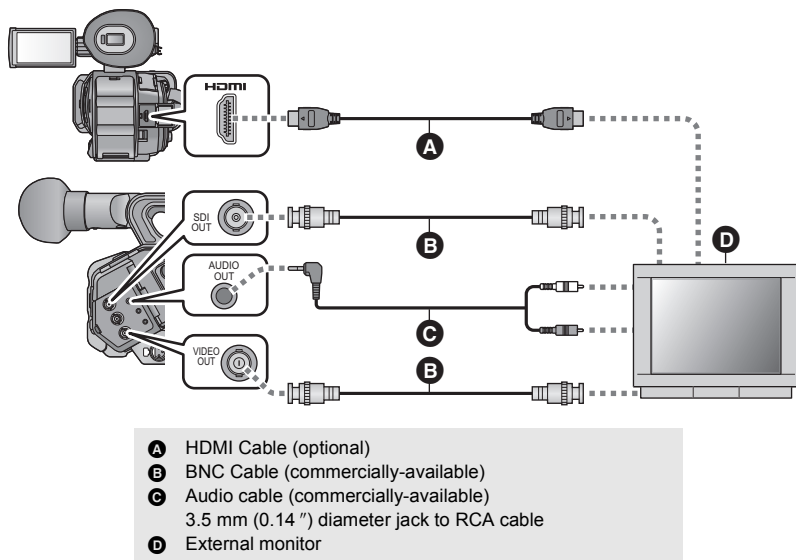

- By connecting this unit to a 4K-compatible external monitor with HDMI Cable and play back scenes recorded with their size set to 4K (4096×2160) or UHD (3840×2160) in [REC FORMAT], you can enjoy finely-detailed 4K motion pictures. For an external monitor that does not support 4K motion picture, you can change the [RESOLUTION] or [HDMI UHD OUTPUT LIMIT] setting so that 4K motion pictures can be played back at a lower resolution.
- If you set [REC FORMAT] to [UHD 2160/59.94p 150M] or [UHD 2160/50.00p 150M] in Recording Mode and then connect this unit to a 4K-compatible external monitor with an HDMI cable, images will be output in 3840×2160 when recording is stopped and in 1920×1080 during recording or PRE-REC. Please note that the image on the screen of this unit and on the external monitor disappears for a few seconds every time you start or stop recording or every time you switch the PRE-REC on/off.

These irregularities do not occur when [RESOLUTION] is set to [1080p] or [1080i], which outputs images in 1920×1080.

**When connecting with an HDMI cable using an HDMI-to-DVI converter, etc., be sure to connect the HDMI cable to the connector of this unit last.
Connecting the HDMI cable to the connector of this unit first may result in malfunction.**

- This unit is not compatible with the VIERA Link.
- Use a commercially-available High Speed HDMI cable.
If possible, we recommend using a cable with a length of 3 m (9.84 feet) or less.
- Use a commercially-available, double-shielded BNC cable equivalent to 5C-FB.

- If you connect this unit to the external monitor when this unit is set to Recording Mode, a squealing sound* may be output. Before connecting this unit, set it to Playback Mode.
- * The microphone may pick up the sound from the speakers, producing an abnormal sound.
- When the external monitor is connected via the VIDEO OUT terminal of this unit, even if you set [RESOLUTION] to [DOWN CONV.], scenes with a recording format size of 4K (4096×2160) cannot be output.

■ To display the on-screen information on the external monitor

When the menu setting is changed, the information displayed on the screen (operation icon and Counter display etc.) can be displayed/not displayed on the external monitor.

- (In Recording Mode)
Set [OUTPUT BITS] to [4:2:2(8bit)]. (→ 31)

 : [DISP SETUP] → [VIDEO OUT OSD] → [ON] or [OFF]

- This item is set to [OFF] in the following situations when this unit is in Recording Mode:
 - When [OUTPUT BITS] is set to [4:2:2(10bit)]
 - When [REC FORMAT] is set to a setting with a size of 4K (4096×2160) or UHD (3840×2160) (→ 151)
 - During auto recording (→ 90, 179)

Setting the external output resolution

When connecting this unit to an external monitor or other external device (recorder, etc.), select the settings below that match the terminal to be used.

1 Select the [OUTPUT SEL] menu.

 : [OUTPUT SETUP] → [OUTPUT SEL] → desired setting

- [HDMI]: Select this setting when connecting to the HDMI OUT terminal.
- [SDI]: Select this setting when connecting to the SDI OUT terminal.
- [SDI+AV]: Select this setting when connecting to the VIDEO OUT terminal.

2 Select the [RESOLUTION] menu.

 : [OUTPUT SETUP] → [RESOLUTION] → desired setting

[SYSTEM]/[1080p]/[1080i]/[DOWN CONV.]

- [SYSTEM] automatically sets the output resolution according to the setting in [REC FORMAT] or [OUTPUT FORMAT].
If the images are not output on the external device when the setting is [SYSTEM], switch to the method [1080p], [1080i] or [DOWN CONV.] which enables the images to be displayed on your external device. (Please read the operating instructions for the external device.)
- [DOWN CONV.] outputs images in standard picture quality.

- When [OUTPUT BITS] (→ 31) is set to [4:2:2(10bit)], following settings are not available:
 - [OUTPUT SEL] is set to [SDI+AV].
 - [RESOLUTION] is set to [DOWN CONV.].
- When [REC FORMAT] or [OUTPUT FORMAT] is set to [4K 2160/24.00p 100M], following settings are not available:
 - [OUTPUT SEL] is set to [SDI+AV].
 - [RESOLUTION] is set to [1080i] or [DOWN CONV.].
- When [REC FORMAT] is set to [SA 480/59.94i] or [SA 576/50.00i], [RESOLUTION] is fixed to [SYSTEM].
- When [OUTPUT SEL] is set to [SDI+AV], [RESOLUTION] is fixed to [DOWN CONV.].
- [RESOLUTION] cannot be set during Freeze Frame. (→ 81)
- Images may not be displayed on the external device for several seconds in some cases, such as when changing between scenes.

Resolution of images output to the external device

Depending on the [RESOLUTION] setting and connected terminal, the resolution of images output to the external device varies.

When [OUTPUT BITS] is set to [4:2:2(8bit)]/In Playback Mode

- When [RESOLUTION] is set to [SYSTEM], the resolution of images output to the external device varies depending on the picture size and frame rate in [REC FORMAT].

(When [SYSTEM FREQ] is set to [59.94Hz])

Setting		Resolution of images output to the external device		
Picture size/Frame rate in [REC FORMAT]	[RESOLUTION] setting	HDMI OUT terminal	SDI OUT terminal	VIDEO OUT terminal
4K (4096×2160)/24.00p	[SYSTEM]	2160/24.00p	1080/24.00PsF	—
	[1080p]	1080/24.00p	1080/24.00PsF	
UHD (3840×2160)/59.94p	[SYSTEM]	2160/59.94p*1	1080/59.94p	—
	[1080p]	1080/59.94p		
	[1080i]	1080/59.94i		
	[DOWN CONV.]	480/59.94p	480/59.94i	
UHD (3840×2160)/29.97p	[SYSTEM]	2160/29.97p	1080/29.97PsF	—
	[1080p]	1080/59.94p		
	[1080i]	1080/59.94i		
	[DOWN CONV.]	480/59.94p	480/59.94i	
UHD (3840×2160)/23.98p	[SYSTEM]	2160/23.98p	1080/23.98PsF	—
	[1080p]	1080/59.94p		
	[1080i]	1080/59.94i		
	[DOWN CONV.]	480/59.94p	480/59.94i	
FHD (1920×1080)/59.94p, PS 1080/59.94p	[SYSTEM]	1080/59.94p		—
	[1080p]	1080/59.94p		
	[1080i]	1080/59.94i		
	[DOWN CONV.]	480/59.94p	480/59.94i	

Setting		Resolution of images output to the external device		
Picture size/Frame rate in [REC FORMAT]	[RESOLUTION] setting	HDMI OUT terminal	SDI OUT terminal	VIDEO OUT terminal
FHD (1920×1080)/ 59.94i, PH 1080/59.94i, HA 1080/59.94i, HE 1080/59.94i	[SYSTEM]	1080/59.94i		—
	[1080p]	1080/59.94p		
	[1080i]	1080/59.94i		
	[DOWN CONV.]	480/59.94p	480/59.94i	
FHD (1920×1080)/ 29.97p	[SYSTEM]	1080/29.97p	1080/29.97PsF	—
	[1080p]	1080/59.94p		
	[1080i]	1080/59.94i		
	[DOWN CONV.]	480/59.94p	480/59.94i	

*1 For this resolution (2160/59.94p), an [OUTPUT BITS] setting of 4:2:0 (8bit) will be set. When you record motion picture with this unit, a resolution of 1080/59.94p with an [OUTPUT BITS] setting of 4:2:2 (8bit) will be set.

Setting		Resolution of images output to the external device		
Picture size/Frame rate in [REC FORMAT]	[RESOLUTION] setting	HDMI OUT terminal	SDI OUT terminal	VIDEO OUT terminal
FHD (1920×1080)/ 23.98p, PH 1080/23.98p	[SYSTEM]	1080/23.98p	1080/23.98PsF	—
	[1080p]	1080/59.94p		
	[1080i]	1080/59.94i		
	[DOWN CONV.]	480/59.94p	480/59.94i	
PM 720 (1280×720)/ 59.94p	[SYSTEM]	720/59.94p		—
	[1080p]	1080/59.94p		
	[1080i]	1080/59.94i		
	[DOWN CONV.]	480/59.94p	480/59.94i	
SA 480 (750×480)/ 59.94i	[SYSTEM]	480/59.94p	480/59.94i	
In Playback Mode (still picture)	[SYSTEM]	1080/59.94p		—
	[1080p]			
	[1080i]	1080/59.94i		
	[DOWN CONV.]	480/59.94p	480/59.94i	

(When [SYSTEM FREQ] is set to [50.00Hz])

Setting		Resolution of images output to the external device		
Picture size/Frame rate in [REC FORMAT]	[RESOLUTION] setting	HDMI OUT terminal	SDI OUT terminal	VIDEO OUT terminal
4K (4096×2160)/24.00p	[SYSTEM]	2160/24.00p	1080/24.00PsF	—
	[1080p]	1080/24.00p	1080/24.00PsF	
UHD (3840×2160)/ 50.00p	[SYSTEM]	2160/50.00p ^{*2}	1080/50.00p	—
	[1080p]	1080/50.00p		
	[1080i]	1080/50.00i		
	[DOWN CONV.]	576/50.00p	576/50.00i	

Setting		Resolution of images output to the external device		
Picture size/Frame rate in [REC FORMAT]	[RESOLUTION] setting	HDMI OUT terminal	SDI OUT terminal	VIDEO OUT terminal
UHD (3840×2160)/ 25.00p	[SYSTEM]	2160/25.00p	1080/25.00PsF	—
	[1080p]	1080/50.00p		
	[1080i]	1080/50.00i		
	[DOWN CONV.]	576/50.00p	576/50.00i	
FHD (1920×1080)/ 50.00p, PS 1080/50.00p	[SYSTEM]	1080/50.00p		—
	[1080p]	1080/50.00p		
	[1080i]	1080/50.00i		
	[DOWN CONV.]	576/50.00p	576/50.00i	
FHD (1920×1080)/ 50.00i, PH 1080/50.00i, HA 1080/50.00i, HE 1080/50.00i	[SYSTEM]	1080/50.00i		—
	[1080p]	1080/50.00p		
	[1080i]	1080/50.00i		
	[DOWN CONV.]	576/50.00p	576/50.00i	

- *2 For this resolution (2160/50.00p), an [OUTPUT BITS] setting of 4:2:0 (8bit) will be set. When you record motion picture with this unit, a resolution of 1080/50.00p with an [OUTPUT BITS] setting of 4:2:2 (8bit) will be set.

Setting		Resolution of images output to the external device		
Picture size/Frame rate in [REC FORMAT]	[RESOLUTION] setting	HDMI OUT terminal	SDI OUT terminal	VIDEO OUT terminal
FHD (1920×1080)/ 25.00p	[SYSTEM]	1080/25.00p	1080/25.00PsF	—
	[1080p]	1080/50.00p		
	[1080i]	1080/50.00i		
	[DOWN CONV.]	576/50.00p	576/50.00i	
PM 720 (1280×720)/ 50.00p	[SYSTEM]	720/50.00p		—
	[1080p]	1080/50.00p		
	[1080i]	1080/50.00i		
	[DOWN CONV.]	576/50.00p	576/50.00i	
SA 576 (750×576)/ 50.00i	[SYSTEM]	576/50.00p	576/50.00i	
In Playback Mode (still picture)	[SYSTEM]	1080/50.00p		—
	[1080p]	1080/50.00p		
	[1080i]	1080/50.00i		
	[DOWN CONV.]	576/50.00p	576/50.00i	

- If you enable Variable Frame Rate Mode when [RESOLUTION] is set to [SYSTEM], the resolution will be set to either 1080/59.94p or 1080/50.00p. (→ 91)

When [OUTPUT BITS] is set to [4:2:2(10bit)]

- When [RESOLUTION] is set to [SYSTEM], the resolution of images output to the external device varies depending on the picture size and frame rate in [OUTPUT FORMAT].

(When [SYSTEM FREQ] is set to [59.94Hz])

Setting		Resolution of images output to the external device	
Picture size/Frame rate in [OUTPUT FORMAT]	[RESOLUTION] setting	HDMI OUT terminal	SDI OUT terminal
4K (4096×2160)/24.00p	[SYSTEM]	2160/24.00p	1080/24.00PsF
	[1080p]	1080/24.00p	1080/24.00PsF
UHD (3840×2160)/29.97p	[SYSTEM]	2160/29.97p	1080/29.97PsF
	[1080p]	1080/59.94p	
	[1080i]	1080/59.94i	
UHD (3840×2160)/23.98p	[SYSTEM]	2160/23.98p	1080/23.98PsF
	[1080p]	1080/59.94p	
	[1080i]	1080/59.94i	
FHD (1920×1080)/59.94p	[SYSTEM]	1080/59.94p	
	[1080p]	1080/59.94i	
	[1080i]	1080/59.94i	
FHD (1920×1080)/59.94i	[SYSTEM]	1080/59.94i	
	[1080p]	1080/59.94p	
	[1080i]	1080/59.94i	
FHD (1920×1080)/29.97p	[SYSTEM]	1080/29.97p	1080/29.97PsF
	[1080p]	1080/59.94p	
	[1080i]	1080/59.94i	
FHD (1920×1080)/23.98p	[SYSTEM]	1080/23.98p	1080/23.98PsF
	[1080p]	1080/59.94p	
	[1080i]	1080/59.94i	

(When [SYSTEM FREQ] is set to [50.00Hz])

Setting		Resolution of images output to the external device	
Picture size/Frame rate in [OUTPUT FORMAT]	[RESOLUTION] setting	HDMI OUT terminal	SDI OUT terminal
4K (4096×2160)/24.00p	[SYSTEM]	2160/24.00p	1080/24.00PsF
	[1080p]	1080/24.00p	1080/24.00PsF
UHD (3840×2160)/25.00p	[SYSTEM]	2160/25.00p	1080/25.00PsF
	[1080p]	1080/50.00p	
	[1080i]	1080/50.00i	

Setting		Resolution of images output to the external device	
Picture size/Frame rate in [OUTPUT FORMAT]	[RESOLUTION] setting	HDMI OUT terminal	SDI OUT terminal
FHD (1920×1080)/50.00p	[SYSTEM]	1080/50.00p	
	[1080p]		
	[1080i]		
FHD (1920×1080)/50.00i	[SYSTEM]	1080/50.00i	
	[1080p]	1080/50.00p	
	[1080i]	1080/50.00i	
FHD (1920×1080)/25.00p	[SYSTEM]	1080/25.00p	1080/25.00PsF
	[1080p]	1080/50.00p	
	[1080i]	1080/50.00i	



Connecting to a PC (File transfer/nonlinear editing)

When this device and a computer for editing are connected using a USB 3.0 Cable (commercially-available), image data in the SD card can be transferred.

- This unit supports USB 3.0.
- Concerning non-linear editing, refer to the instruction manual of your editing software.
- It is impossible to write data to the SD card on this unit from a PC.

Operating environment (mass storage)

- Even if the system requirements mentioned in these operating instructions are fulfilled, some PCs cannot be used.
- The USB equipment operates with the driver installed as standard in the OS.

■ If using Windows

- Operation is not guaranteed in the following cases.
 - Operation on an upgraded OS.
 - Operation on an OS other than the one pre-installed.

OS	Windows 10 (32 bit/64 bit) Windows 8/Windows 8.1 (32 bit/64 bit) Windows 7 (32 bit/64 bit) SP1
CPU	1 GHz or higher 32-bit (×86) or 64-bit (×64) processor
RAM	2 GB or more (64 bit)/1 GB or more (32 bit)
Interface	USB port
Other requirements	Mouse or equivalent pointing device

■ If using Mac

PC	Mac
OS	OS X v10.10
CPU	Intel Core 2 Duo or better
RAM	2 GB or more
Interface	USB port
Other requirements	Mouse or equivalent pointing device

Connecting to a PC

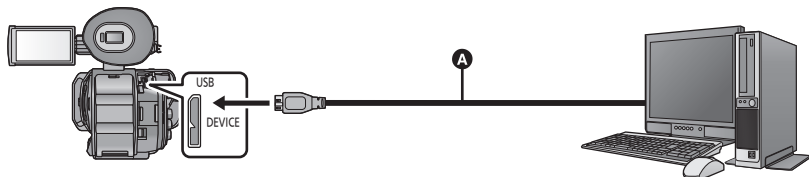

A USB 3.0 Cable (commercially-available)

- Insert the plugs as far as they will go.

1 Connect this unit to the AC adaptor.

- Use the AC adaptor to free you from worrying about the battery running down.

2 Turn on the unit.

3 Press the THUMBNAIL button to switch this unit to the Playback Mode.

4 Set [USB MODE SELECT] to [DEVICE].

MENU
[MENU] : [OTHER FUNCTION] → [USB MODE SELECT] → [DEVICE]

5 Set [USB MODE] to [ON].

MENU
[MENU] : [OTHER FUNCTION] → [USB MODE] → [ON]

6 Connect this unit to a PC.

- The USB function selection screen will appear.

7 Touch [PC] on the screen of this unit.

- This unit is automatically recognized as an external drive of the PC. (→ 124)
- When you select an option other than [PC], reconnect the USB Cable.
- When using the battery, the LCD monitor turns off after about 5 seconds. Touch the screen to turn the LCD monitor on.

-
- A USB 3.0 cable is not supplied with this unit. Use a commercially-available double-shielded USB 3.0 cable with a ferrite core.
If possible, we recommend using a cable with a length of 1.5 m (4.9 feet) or less.
 - When performing reading/writing between a PC and an SD card, be aware that some SD card slots built into PCs and some SD card readers are not compatible with the SDHC Memory Card or SDXC Memory Card.
 - If you are using an SDXC Memory Card, some PC may not recognize the data. Make sure your PC supports SDXC cards.

■ To disconnect USB Cable safely

(For Windows)

Select the  icon in task tray displayed on the PC, and then click the on-screen display that lets you eject [AG-DVX200].

- Depending on your PC's settings, this icon may not be displayed.

(For Mac)

Drag [CAM_SD] disk icon to the [Trash], and then disconnect the USB Cable.

About the screen indication of the unit

- Do not disconnect the USB Cable, battery, or AC adaptor while the access lamp is on or card access icon () appears on the unit screen.
- If the screen does not change when the unit is operated while connected to a PC, disconnect the battery and/or AC adaptor, wait approximately 1 minute, reconnect the battery and/or AC adaptor, wait approximately 1 minute again, and then turn the unit back on. (Data may be destroyed when above operation is performed while accessing the SD card.)

About the PC display

When the unit is connected to a PC, it is recognized as an external drive.

- Removable disk (Example:  CAM_SD (F:)) is displayed in [Computer].

Data recorded using AVCHD format has excellent compatibility with computers, due to its file form; however, it contains not just image and sound data, but also various important information, and it is associated using a folder structure which is like a figure. If even part of this information is changed or erased, faults may occur; for example, it may not be possible for the data to be recognized as AVCHD data, or it may no longer be possible for the SD card to be used in an AVCHD device.

Data from a computer cannot be written to the SD card of this device.

Example folder structure of a SD card:

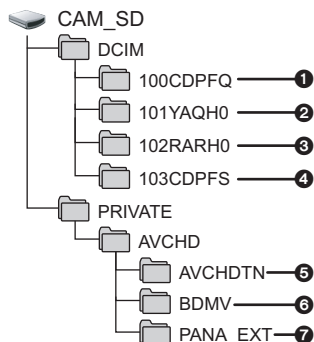

The following data will be recorded.

- 1 Up to 999 still pictures in JPEG format ([01000001.JPG] etc.)
- 2 MOV format motion picture data ([01000001.MOV], etc.)
- 3 MP4 format motion picture data ([01000001.MP4], etc.)
- 4 JPEG format still pictures created from the motion picture
- 5 The motion picture thumbnails
- 6 AVCHD format motion picture files ([00000.MTS] etc.)
- 7 For management

Folder names for motion picture data recorded in MOV/MP4 format

The fourth to eighth characters of the folder name of a recorded MOV/MP4 scene are determined by its picture size, frame rate, motion picture format, recording setting and camera number setting.

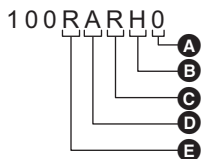

- A** Camera number setting (→ 159)
- B** Recording setting
- C** Motion picture format
- D** Frame rate
- E** Picture size

(Example) If the folder name is 100RARHO:

Motion picture data that has a picture size of 3840×2160, frame rate of 59.94 fps, and motion picture format categorized as progressive recording (MP4 and LPCM) is stored.

Picture size	Frame rate	Motion picture format	Recording setting
Y: 1920×1080	A: 59.94 fps	J: Interlace recording (MOV, LPCM)	H: Recordings other than the ones below
R: 3840×2160	B: 50 fps	K: Interlace recording (MP4, LPCM)	D: Sub recordings of dual codec recording (50 Mbps)
Q: 4096×2160	C: 29.97 fps	Q: Progressive recording (MOV, LPCM)	E: Sub recordings of dual codec recording (8 Mbps)
	D: 25 fps	R: Progressive recording (MP4, LPCM)	P: Main recordings of dual codec recording
	E: 24 fps	X: FastScan recording (MP4, LPCM)	
	F: 23.98 fps	Y: FastScan recording (MOV, LPCM)	

- Do not delete the SD card's folders on a PC. Doing so may make the SD card unusable in this unit.
- When data not supported by this unit has been recorded on a PC, it will not be recognized by this unit.
- Always use this unit to format SD cards.



Copying/playing back with an external media device

● In these Operating Instructions, “USB hard disk drive” is indicated as “USB HDD”.
If you connect an external media device, such as USB HDD or USB flash memory (commercially-available) to this unit, you can copy motion pictures and still pictures recorded on this unit to an external media device.

It can also play back the scenes and still pictures copied to the external media device.

- This unit supports USB 3.0.
- You can copy scenes and still pictures recorded with this unit while maintaining the image quality.
- Please read the operating instructions of the external media device for how to use it.

Preparing for copying/playing back

Refer to the following support site for information about an external media device.

<https://pro-av.panasonic.net/>

(This Site is English only)

When the external media device that requires formatting is connected, a message is displayed. Follow the instructions on the screen to format it.

Once the external media device has been formatted, all data stored on it will be deleted. The data cannot be recovered.

This unit formats the external media device in exFAT.

- In the following cases, an external media device cannot be used by connecting it to this unit:
 - An external media device with a capacity below 32 GB or above 2 TB
 - When an external media device has two or more partitions
 - If an external media device is in a format other than FAT32 or exFAT
 - When connected by using a USB hub
- You cannot copy scenes recorded on an SDXC Memory Card to an external media device in FAT32 format.

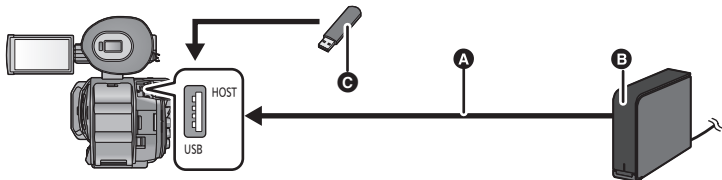

- A** Connect this unit to the external device with USB Cable (supplied with the external media device)
- B** External media device (commercially-available)
- C** USB flash memory (commercially-available)

1

(When using USB HDD)

Connect the AC adaptor (supplied with USB HDD) to the USB HDD.

- If you are using a bus-powered or portable USB HDD, this unit can supply power to the USB HDD by USB Cable (supplied with USB HDD).

2 Connect the AC adaptor to this unit.

- Use the AC adaptor to free you from worrying about the battery running down.

3 Turn on this unit, and press the THUMBNAIL button to switch to Playback Mode.

4 Set [USB MODE SELECT] to [HOST].

 : [OTHER FUNCTION] → [USB MODE SELECT] → [HOST]

5 Set [USB MODE] to [ON].

 : [OTHER FUNCTION] → [USB MODE] → [ON]

6 Connect the external media device to the USB HOST terminal of this unit.

- If you use a USB HDD, connect to the USB HDD with the USB Cable supplied with the USB HDD.
- It may take several minutes until the connection is completed.

7 Touch the desired item.

[COPY ONCE]:	Copies all scenes and still pictures recorded with this unit that have not been copied yet. (→ 128)
[SELECT COPY]:	Allows you to select desired scenes/still pictures, and then copy. (→ 129)
[Playback from External Media]:	Plays back scenes and still pictures stored in an external media device on this unit. (→ 130)
[Safe Removal]:	Allows you to safely remove this unit and an external media device.

When the external media device is connected to other devices such as Blu-ray disc recorder, a message prompting to format the external media device may display. All the scenes and still pictures recorded on the external media device will be erased if formatted. Do not format as important data will get erased and it will be impossible to restore.

■ Points to check before copying

- When using an external media device for the first time, or using an external media device that has been used with other devices, first run [FORMAT MEDIA].
- Before copying, go to [MEDIA STATUS] to check the amount of free space on the external media device. (→ 128)
- It may take longer to copy when there are many scenes.
- If you copy protected scenes or still pictures, the protection setting of the copied scenes or still pictures are canceled.
- The order in which the scenes were copied cannot be changed.

Before you delete the data on the SD card after copying is complete, be sure to play back the external media device to check that they have been copied to correctly. (→ 130)

■ Formatting

This is for initializing the external media device.

- **Please be aware that if a media is formatted then all the data recorded on the media is erased and cannot be recovered. Back up important data on a PC etc.**
- **Connect this unit to the external media device and touch [Playback from External Media]. Select the menu.**



- When formatting is complete, touch [EXIT] to exit the message screen.
- Connect this unit and the external media device to format.
You may no longer be able to use the external media device if you format them on another device such as a PC etc.
- This unit formats the external media device in exFAT.

■ Displaying media information

The used space of the external media device can be checked.

- **Connect this unit to the external media device and touch [Playback from External Media]. Select the menu.**

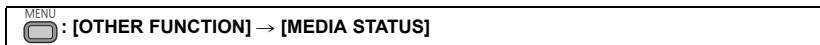

- If you touch [CHANGE MEDIA], you can switch the display between the SD card 1, SD card 2, and the external media device.

Copy once

1 Connect this unit to the external media device to prepare for copying. (→ 126)

2 Touch [COPY ONCE].

- You can also access this function by selecting menu items.
[COPY] → [COPY ONCE]

3 Touch the media you want to copy.

4 Touch [YES].

5 Touch [EXIT] when the copy complete message is displayed.

- The thumbnail view of the copy destination is indicated.

When you stop copying halfway:

Touch [CANCEL] while copying.

Copy selected files



1 Connect this unit to the external media device to prepare for copying. (→ 126)



2 Touch [SELECT COPY].

- You can also access this function by selecting menu items.

[COPY] → [SELECT COPY]

3 Touch the media you want to copy.

[ → ]: When copying from the SD card 1 to the external media device.

[ → ]: When copying from the SD card 2 to the external media device.

- For information on copying between SD cards, refer to page 112.

4 Touch the desired items following the instructions on the screen.

- It will return to the previous step by touching [Return].

- (When [SELECT SCENES] is selected)

When touched, the scene/still picture is selected and the  indication appears on the thumbnail. Touch the scene/still picture again to cancel the operation.

- (When [SELECT DATE] is selected)

When touched, the date is selected and surrounded by red. Touch the date again to cancel the operation.

- Up to 99 scenes/ 99 dates can be selected continuously.

5 Touch [EXIT] when the copy complete message is displayed.

- The thumbnail view of the copy destination is indicated.

When you stop copying halfway:

Touch [CANCEL] while copying.

Playing back the External Media

- Only motion picture/still picture that have been copied by connecting this unit to the external media device can be played back.

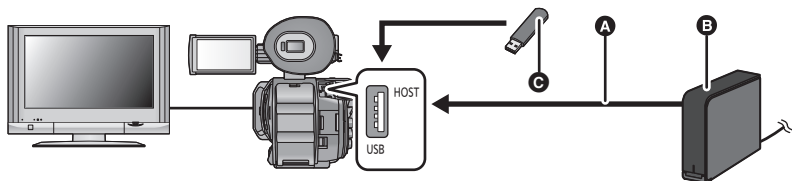

- A** USB Cable (supplied with USB HDD)
- B** USB HDD (commercially-available)
- C** USB flash memory (commercially-available)

1 Connect this unit to the external media device to prepare for playback. (→ 126)

- When playing back on an external monitor, connect this unit to the external monitor. (→ 115)

2 Touch [Playback from External Media].

3 Touch the scene or still picture to be played back and then play it back.



- The playback operation is performed the same as when playing back motion pictures or still pictures. (→ 102, 106)

To terminate the connection between this unit and the external media device

Touch the play mode select icon (→ 102) and then touch .

- Disconnect the USB Cable from this unit.



- It is also possible to switch the media to play back by touching the play mode select icon. When the external media device is connected, the  (external media device) can be selected from the displayed media types. (→ 102)
- In the following cases, when you have touched a play mode select icon and selected the recording format for playback, this unit will be restarted to change the system frequency. After the restart, perform Step 2.
 - When you have switched recording format from [4K/24.00p] to a different option.
 - When you have switched recording format from an option other than [4K/24.00p] to [4K/24.00p]
- Deleting scenes and still pictures on the external media device may take time.
- You cannot set the [SCENE PROTECT] during playback of  (external media device). (→ 111)

Using an iPad as a Remote Control (AG ROP application)

Attaching a wireless module that support this unit (→ 132) to the USB HOST terminal of this unit allows you to connect to a wireless LAN network. You can remotely control some functions by connecting this unit and an iPad on which the AG ROP application is installed.

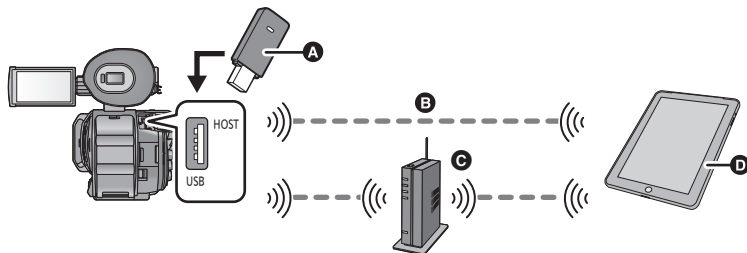

- A** Wireless module that support this unit
- B** Direct connection
- C** Wireless access point connection
- D** iPad and AG ROP application

You can perform the following remote control operations with the AG ROP application:

- Checking the camera status
- Playing back scenes recorded as sub recordings with [DUAL CODEC REC] set to [FHD 8Mbps] and checking the thumbnails of these scenes
- Controlling the camera remotely (recording control and Time Code/User Information operations)

-
- For information on how to operate the AG ROP application, refer to its Help.
 - After removing the wireless module, you can store it in the grip belt.

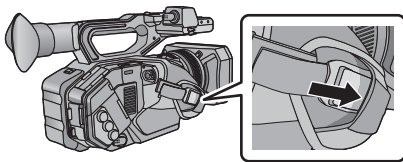

Before connection

iPad/AG ROP application

Install the AG ROP application on the iPad.

- Download the AG ROP application from the App StoreSM.
- Supported OS for the AG ROP application: iOS 7.1 or later (as of January 2016)

Wireless module

Attach a wireless module that support this unit to the USB HOST terminal of this unit.

- Wireless module that support this unit (as of January 2016)
 - Panasonic : AJ-WM30
 - ASUS : USB-N53 (Ver.A1)
- For details on wireless modules that support this unit, refer to the support desk at the following website.
<https://pro-av.panasonic.net>

■ Notes on the use of a Panasonic wireless module (AJ-WM30: optional)

Before use, carefully read the manual of the wireless module carefully to fully understand its content. The following limitations apply to prevent accidental operations:

- Supported standard: IEEE802.11g/n
IEEE802.11a and IEEE802.11b cannot be used.
- Communication frequency: 2412 MHz to 2462 MHz (1ch, 6ch, 11ch)
12ch and higher cannot be used.

For overseas use

The four types of products below are available to comply with laws regulating radio waves in every region of the world.

The products can be used only in the country or region where they are supported.

Model number	Compatible countries and regions
AJ-WM30MC	People's Republic of China
AJ-WM30P	United States, Canada, Mexico, Argentina, Peru, Taiwan
AJ-WM30E	EU countries, EFTA countries, Australia, New Zealand, Russia, Ukraine, Saudi Arabia, United Arab Emirates, Kuwait, Oman, Egypt, Republic of South Africa, South Korea, Philippines, Malaysia, Singapore
AJ-WM30	Japan

- Outdoor use is prohibited in France.

Settings to be made on this unit

To connect an iPad to this unit via wireless LAN, the following information on this unit is required:

- User account name
- Password
- IP address
- If you set [DHCP] in [Wireless LAN setup] to [SERVER] and connect to a network, you are not required to set the IP address.
- The user account and password can be set in [USER ACCOUNT].
- The IP address can be set in [Wireless LAN setup]. (→ 133)

■ Setting the user account name and password

1 Select the menu.

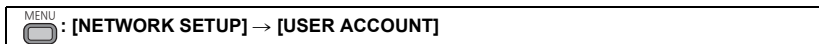

- 2 Touch [SET].
 - 3 Select and touch an item that has not been registered.
 - 4 Touch [Refresh]
- Touch [DELETE] to clear the selected user account.
- 5 Enter a user account name.
- Enter a maximum of 31 characters.
 - After entering the title, touch [Enter].

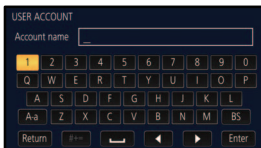

Entering text

Operate in the same way as you enter characters with a keyboard.

Icon	Description of operation
[A-a]	Switches between uppercase and lowercase.
[Return]	Returns to the previous screen.
[#+=]	Switches to symbols and numbers.
[]	Enters a space.
[BS]	Deletes a character. Deletes the previous character if the cursor is in an empty space.
[◀ / ▶]	Moves the cursor to left or right.
[Enter]	Ends text entry.

- 6 Enter a password.
- Enter between 6 and 31 characters.
 - After entering the title, touch [Enter].
- 7 Re-enter the password.
- When the entry is complete, touch [Enter].
- 8 Touch [RETURN].
- Touch [EXIT] to exit the menu screen.

-
- The default setting is [OFF] with a user account name of [guest] and a password of [aggest].
 - Apply the set user account name and password to [AG ROP] in [Settings] on the iPad. For details, refer to [CONNECTION] in Help of the AG ROP app.

■ Configuring the wireless LAN settings (IP address, etc.)

- 1 Select the menu.

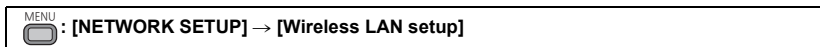

- 2 Touch and set the desired items as needed.
- All default settings are indicated with underlined text.

- [IP Address]: Enter the IP address.
- The default setting is [192.168.0.1].
- [Subnet Mask]: Enter the subnet mask.
- The default setting is [255.255.255.0].

[Gateway]:	Enter the gateway. • The default setting is [192.168.0.254].
[DHCP]:	[OFF]: Disables automatic retrieval by DHCP and the DHCP server function.
	[CLIENT]: Performs automatic retrieval by DHCP when connecting with [WIRELESS SETUP] set to [SSID(SELECT)] or [SSID(MANUAL)].
	[SERVER]: Enables the DHCP server function when connecting with [WIRELESS SETUP] set to [DIRECT].
[MAC Address]:	Displays the MAC address.

- If you make a connection with [WIRELESS SETUP] set to [DIRECT], the [Gateway] setting will be disabled.
- [IP Address], [Subnet Mask], and [Gateway] cannot be set when [DHCP] is set to [CLIENT].
- [MAC Address] cannot be changed.
- For details on how to enter characters, refer to page 133.

3 Touch [EXIT].

- A connection cannot be made unless the combination of the IP address, subnet mask, and gateway are correct.
- When not using the gateway, set it to [0.0.0.0].
- When [DHCP] is set to [OFF] or [CLIENT], apply the [IP Address] setting to [AG ROP] in [Settings] on the iPad. For details, refer to [CONNECTION] in Help of the AG ROP app.

Connecting this unit and an iPad

- **Change the mode to Recording Mode. (→ 23)**

If you switch to Recording Mode while this unit is connected in Playback Mode, the connection may be terminated to restart this unit. We recommend setting this unit to Recording Mode before making a connection.

■ Settings to be made on the iPad

For information on the settings to be made on the iPad, refer to [CONNECTION] in Help of the AG ROP app.

■ Icons to be displayed during connection



Wireless LAN connection:

- connected/ not connected
- The display will change as follows according to the radio wave intensity: (Weak) → → (Strong).

AG ROP application connection:

- connected
- The display will change as follows according to the radio wave intensity: (Weak) → → (Strong).

Connecting directly

Configure the settings in this section to directly connect this unit and the iPad.

- Attach a wireless module that support this unit to the USB HOST terminal of this unit. (→ 132)
- Set [USB MODE SELECT] to [HOST]. (→ 189)
- Set [USB MODE] to [ON]. (→ 189)

1 Select the menu.

 : [NETWORK SETUP] → [WIRELESS SETUP] → [DIRECT]

2 Touch and set the desired items as needed.

- All default settings are indicated with underlined text.

[SSID]:	Enter the network name (SSID) for this unit.
[BAND]:	Select the frequency band to be used. <u>[2.4GHz]</u> / <u>[5GHz]</u>
[CHANNEL (2.4GHz)]:	Sets the channel to be used for 2.4 GHz. <u>[AUTO]</u> / <u>[CH1]</u> / <u>[CH6]</u> / <u>[CH11]</u>
[CHANNEL (5GHz)]:	Sets the channel to be used for 5 GHz. <u>[AUTO]</u> / <u>[CH36]</u> / <u>[CH40]</u> / <u>[CH44]</u> / <u>[CH48]</u>
[Password]:	Sets the password. <ul style="list-style-type: none">● The default setting is [01234567890123456789abcdef].

- When [DIRECT] is selected, [SECURITY TYPE] is fixed to [WPA2-AES].
- Some settings in [BAND], [CHANNEL (2.4GHz)] and [CHANNEL (5GHz)] cannot be selected depending on the wireless module used.
- For details on how to enter characters, refer to page 133.

3 Touch [RETURN].

4 Set [DHCP] to [SERVER].

 : [NETWORK SETUP] → [WIRELESS SETUP] → [DHCP] → [SERVER]

5 Touch [EXIT].

6 Select the SSID of this unit from the Wi-Fi® setup of the iPad.

7 Enter the password into the iPad.

8 Check the network connection.

- When this unit is ready to be connected,  will be displayed on its screen.
- To terminate the connection, after terminating the connection on the iPad side, set [USB MODE] to [OFF].

Connecting to a wireless access point

Configure the settings in this section to connect this unit and an iPad using a wireless access point.

■ Searching for wireless access points to set up a connection

- Attach a wireless module that support this unit to the USB HOST terminal of this unit. (→ 132)
- Set [USB MODE SELECT] to [HOST]. (→ 189)
- Set [USB MODE] to [ON]. (→ 189)

1 Select the menu.

 : [NETWORK SETUP] → [WIRELESS SETUP] → [SSID(SELECT)]

2 Touch the wireless access point to connect to.

- The SSIDs of wireless access points found with the search will be displayed.
- If you touch [Refresh], you can search for wireless access points again.

3 Touch [ENTER].

- If an encryption key (password) is not set, the setup is complete.

4 (If an encryption key (password) is set)

Enter the password.

- For details on how to enter characters, refer to page 133.
- When the connection is complete, touch [Enter].

5 Check the network connection.

- When the connection is complete,  is displayed on the screen of this unit.
- To terminate the connection, after terminating the connection on the iPad side, set [USB MODE] to [OFF].

-
- [SSID(SELECT)] is available only when [USB MODE] is set to [ON], [USB MODE SELECT] is set to [HOST] and a wireless module that supports this unit is attached.
 - Depending on your environment, the communication speed may become slower or the wireless access point may not be available for use.
 - When [DHCP] in [Wireless LAN setup] is set to [OFF] or [CLIENT], apply the [IP Address] setting to [AG ROP] in [Settings] (→ 133) on the iPad. For details, refer to [CONNECTION] in Help of the AG ROP app.

■ Setting up a connection manually

- Attach a wireless module that support this unit to the USB HOST terminal of this unit. (→ 132)
- Set [USB MODE SELECT] to [HOST]. (→ 189)
- Set [USB MODE] to [ON]. (→ 189)

1 Select the menu.

 : [NETWORK SETUP] → [WIRELESS SETUP] → [SSID(MANUAL)]

2 Touch and set the desired items as needed.

- All default settings are indicated with underlined text.

[SSID]:	Enter the SSID for the wireless access point to connect to. <ul style="list-style-type: none"> • This item is not set by default.
[SECURITY TYPE]:	Set the network authentication and encryption types. <u>[WPA2-AES]/[WPA-AES]/[WPA2-TKIP]/[WPA-TKIP]/[NONE]</u>
[Password]:	Enter the password for the wireless access point to be connected. <ul style="list-style-type: none"> • This item is not set by default. • This item is not available when [SECURITY TYPE] is set to [NONE].

- When [SSID(MANUAL)] is selected, [BAND] is fixed to 2.4 GHz, and [CHANNEL (2.4GHz)] and [CHANNEL (5GHz)] are fixed to [AUTO].
- For details on how to enter characters, refer to page 133.

3 Touch [EXIT].

4 Check the network connection.

- When the connection is complete,  is displayed on the screen of this unit.
- To terminate the connection, after terminating the connection on the iPad side, set [USB MODE] to [OFF].

- Depending on your environment, the communication speed may become slower or the wireless access point may not be available for use.
- When [DHCP] in [Wireless LAN setup] is set to [OFF] or [CLIENT], apply the [IP Address] setting to [AG ROP] in [Settings] (→ 133) on the iPad. For details, refer to [CONNECTION] in Help of the AG ROP app.

■ Connecting from History

Connections made to wireless access points are saved in History. Connecting from History allows you to easily connect with the same settings as used previously.

- **Attach a wireless module that support this unit to the USB HOST terminal of this unit.**
(→ 132)
- **Set [USB MODE SELECT] to [HOST].** (→ 189)
- **Set [USB MODE] to [ON].** (→ 189)

1 Select the menu.

 : [NETWORK SETUP] → [CONNECTION HISTORY]

2 Touch the item you want to connect to.

- Connection records in History will be displayed as SSIDs of wireless access points.
- Touch [DELETE] to clear the selected history data.

3 Touch [EXIT].

4 Check the network connection.

- When the connection is complete,  is displayed on the screen of this unit.
- To terminate the connection, after terminating the AG ROP application connection, set [USB MODE] to [OFF].

- Up to 20 most recently used connections can be stored in History.
- [CONNECTION HISTORY] is available only when [USB MODE] is set to [ON], [USB MODE SELECT] is set to [HOST] and a wireless module that supports this unit is attached.

Operations during AG ROP application connection

■ Operations with the switches of this unit during connection

- The following switches and buttons are disabled:
 - SHUTTER button
 - GAIN switch
 - WHITE BAL switch
 - MENU button (The applicable USER button is also disabled, making it impossible to operate the menu.)
 - BARS button
 - THUMBNAIL button
- You can change the [ZOOM/FOCUS] setting in the [SW SETUP] menu to switch between operating this unit and operating it with the AG ROP application. Since selecting [IP REMOTE] will disable the following switches and buttons, to operate them with this unit, select [CAMERA]:
 - Focus ring
 - Zoom lever
 - Sub zoom lever
 - PUSH AUTO button, USER button to which [PUSH AUTO] is registered.
 - FOCUS A/M/ ∞ switch
 - Switching to Auto Focus Mode with the AUTO/MANU switch (→ 36)
- You can press the IRIS button to switch between operating the iris ring of this unit and operating it with the AG ROP application. The iris ring of this unit cannot be used when you operate this unit with the AG ROP application.

■ Recording and playback operations during connection

You can perform operations with either this unit or the AG ROP application while connected to the AG ROP application.

■ Limitations on this unit during connection

- The following functions are disabled during AG ROP application connection:
 - Magnifying the Focus Assist display (→ 49)
 - Focus Transition (→ 52)
 - USB Mode (USER button) (→ 78)
 - Area Mode (→ 82)
-
- Settings that are changed remotely with the AG ROP application are applied to the corresponding settings of this unit.
 - When [WARNING] is flashing on the AG ROP application screen, remote control operations may not be performed due to an error on this unit. Check this unit. For details, refer to “Warning Indications” on page 201.

Using the Menu

Refer to page 30 for how to set up the Menu.

Scene file



Settings that are assigned to [SCENE1] in [CUSTOMIZE SCENE] by default are indicated with underlined text.

 : [SCENE FILE] → desired setting

[CUSTOMIZE SCENE]

[SCENE1]/[SCENE2]/[SCENE3]/[SCENE4]/[SCENE5]/[SCENE6]

You can save the desired image settings to each scene number. Switch the scene number in accordance with the recording conditions.

1 Touch [CUSTOMIZE SCENE].

2 Touch the scene number.

- The scene number will switch by touching [SCENE1] to [SCENE6].
- Touch [EXIT] to exit the menu screen.

3 (To change the image settings)

Change the setting of [SCENE FILE] menu.

- You can save the settings of the following menu items to the scene number you have selected.

(→ 141 to 148)

- | | |
|------------------------------|----------------------------|
| – [SYNCHRO SCAN] | – [MASTER PED] |
| – [MASTER DETAIL] | – [GAMMA MODE] |
| – [DETAIL CORING] | – [BLACK GAMMA] |
| – [SKIN TONE DTL] | – [BLACK GAMMA RANGE] |
| – [V DETAIL LEVEL] | – [KNEE MODE] |
| – [KNEE APE LEVEL] | – [KNEE MASTER POINT] |
| – [RB GAIN CONTROL SETTING] | – [KNEE MASTER SLOPE] |
| – [CHROMA LEVEL] | – [DRS] |
| – [CHROMA PHASE] | – [DRS EFFECT] |
| – [MATRIX] | – [AUTO IRIS LEVEL] |
| – [COLOR CORRECTION SETTING] | – [AUTO IRIS LEVEL EFFECT] |

Default scene number settings

[SCENE1]	Setting appropriate for standard recording
[SCENE2]	Setting appropriate for recording considering the characteristic of fluorescent lamps (indoors, etc.)
[SCENE3]	Setting appropriate for recording with modulation in resolution, color shade, and contrast
[SCENE4]	Setting appropriate for recording with wider gradation in dark area (dusk, etc.)
[SCENE5]	Setting appropriate for recording as a cinema with high contrast
[SCENE6]	Setting appropriate for recording as a cinema with high dynamic range

- This function's default setting is [SCENE1].
- It is possible to switch the scene file by touching **SCN1** to **SCN6** while displaying the operation icons. (→ 98)
- It will return to the default settings when [SCENE] is selected in [INITIAL SET]. (→ 189)

[SCENE FILE]

[LOAD]/[SAVE]

You can save the scene file settings of [CUSTOMIZE SCENE] to the SD card or load them from the SD card to this unit. (→ 89)

[VFR MODE]

[ON]/[OFF]

This enables/disables Variable Frame Rate Mode.

In Variable Frame Rate Mode, you can record quick or slow motion picture by changing the frame rate before recording.

- For information on how to use Variable Frame Rate Mode, refer to page 91.

- This function's default setting is [OFF].

[FRAME RATE]

You can adjust the frame rate for Variable Frame Rate Mode.

- Set [VFR MODE] to [ON]. (→ 91, above)

1 Touch [FRAME RATE].

2 Touch **▲** / **▼** to adjust the frame rate.

- You can select a value between 2fps and 120fps.

3 Touch [EXIT] to complete the setting.

- When the default setting for [SYSTEM FREQ] is [59.94Hz]:
This function's default setting is "60fps".
When the default setting for [SYSTEM FREQ] is [50.00Hz]:
This function's default setting is "50fps".
- When [REC MODE] and [REC FORMAT] are set to settings that are not available for Variable Frame Rate Mode, [FRAME RATE] cannot be set. (→ 91)
- If you set the frame rate to 100fps or 120fps, the angle of view will change. (The color of the frame rate value will change to blue.)

[SYNCHRO SCAN]

Sets the initial Synchro Scan setting.

- The setting range changes depending on the size and frame rate in [REC FORMAT] or [OUTPUT FORMAT]. (→ 151, 157)

- 1 Touch [SYNCHRO SCAN].
- 2 Touch  /  to adjust settings.
- 3 Touch [EXIT] to complete the setting.

■ Note on the [SYNCHRO SCAN] setting

A separate [SYNCHRO SCAN] setting is maintained for each size and frame rate of [REC FORMAT] or [OUTPUT FORMAT].



- Default settings are indicated with underlined text.

Frame rates	[SYNCHRO SCAN] setting
59.94p/59.94i	(When the size for [REC FORMAT] or [OUTPUT FORMAT] is UHD (3840×2160)) <u>1/60.0</u> to 1/249.7
	(When the picture size for [REC FORMAT] or [OUTPUT FORMAT] is 1920×1080 or below) 1/60.0 to 1/249.8
29.97p	1/30.0 to <u>1/60.0</u> to 1/249.8
23.98p	1/24.0 to 1/48.0 to 1/249.6
24.00p	
50.00p/50.00i	1/50.0 to 1/250.0
25.00p	1/25.0 to 1/50.0 to 1/250.0

- When the default setting for [SYSTEM FREQ] is [59.94Hz]:
This function's default setting is "1/60.0".
When the default setting for [SYSTEM FREQ] is [50.00Hz]:
This function's default setting is "1/50.0".

[MASTER DETAIL]



Adjusts the degree of overall outline correction in images.

- 1 Touch [MASTER DETAIL].
- 2 Touch  /  to adjust settings.
- You can select a value between -31 and +31.
- 3 Touch [EXIT] to exit the menu screen.

- The default setting that is assigned to [SCENE1] in [CUSTOMIZE SCENE] is "0".

[DETAIL CORING]

Adjusts the detail noise removal level.

- 1 Touch [DETAIL CORING].
- 2 Touch  /  to adjust settings.
 - You can select a value between 0 and 60.
- 3 Touch [EXIT] to exit the menu screen.

-
- The default setting that is assigned to [SCENE1] in [CUSTOMIZE SCENE] is “1”.

[SKIN TONE DTL]

[ON]/[OFF]

This makes skin colors appear softer for a more attractive appearance.



This is more effective if you record a person closely from the torso up.

- 1 Touch [SKIN TONE DTL].
- 2 Touch [ON].
- 3 Touch [EXIT] to exit the menu screen.

-
- If the background or anything else in the scene has colors similar to the skin color, they will also be smoothed.
 - If the brightness is insufficient, the effect may not be clear.
 - If you record a person in the distance, the face may not be recorded clearly. In this case, set [SKIN TONE DTL] to [OFF] or zoom in on the face (close-up) to record.

[V DETAIL LEVEL]

Adjusts the degree of vertical outline correction in images.

- 1 Touch [V DETAIL LEVEL].
- 2 Touch  /  to adjust settings.
 - You can select a value between -7 and +7.
- 3 Touch [EXIT] to exit the menu screen.

-
- The default setting that is assigned to [SCENE1] in [CUSTOMIZE SCENE] is “0”.

[KNEE APE LEVEL]

This sets the detail level of high luminosity areas (extremely bright areas).

- 1 Touch **[KNEE APE LEVEL]**.
- 2 Touch the desired setting item.

[0]/[1]/[2]/[3]/[4]/[5]

- 3 Touch **[EXIT]** to exit the menu screen.

[RB GAIN CONTROL SETTING]

This adjusts the color balance for each position of the WHITE BAL switch. You can also set whether or not to apply the color balance settings to Auto White Balance/Auto Black Balance.

- These settings do not work when the White Balance mode is set to [ATW].

- 1 Touch **[RB GAIN CONTROL SETTING]**, and select the desired item.

[AWB PRE]: Setting for the PRST position of the WHITE BAL switch

[AWB A]: Setting for the A position of the WHITE BAL switch

[AWB B]: Setting for the B position of the WHITE BAL switch

- 2 Touch the desired setting item.

[R GAIN]: Adjusts the intensity of red.

[B GAIN]: Adjusts the intensity of blue.

[GAIN OFFSET]*: Sets whether to maintain or reset the [R GAIN] and [B GAIN] settings when Auto White Balance/Auto Black Balance is used.

- * Displayed only if you touch [AWB A] or [AWB B] in Step 1.

- 3 (If you have touched [R GAIN]/[B GAIN] in Step 2)

Touch  /  to adjust the color balance.

- You can select a value between -30 and +30.
- Touch [RETURN].
(If you have touched [GAIN OFFSET] in Step 2)

Touch **[ON]** or **[OFF]**.

[ON]: Maintains the [R GAIN] and [B GAIN] settings when Auto White Balance/Auto Black Balance is used.

[OFF]: Resets the [R GAIN] and [B GAIN] settings when Auto White Balance/Auto Black Balance is used.



- To make additional changes, repeat Steps 2–3.

- 4 Touch **[EXIT]** to exit the menu screen.

-
- The default settings that are assigned to [SCENE1] in [CUSTOMIZE SCENE] are as follows:
 - [R GAIN]: "0"
 - [B GAIN]: "0"
 - [GAIN OFFSET]: [OFF]

[CHROMA LEVEL]



Adjusts color density.

- 1 Touch [CHROMA LEVEL].
- 2 Touch  /  to adjust settings.
 - You can select a value between -70 and +30.
- 3 Touch [EXIT] to exit the menu screen.

-
- The default setting that is assigned to [SCENE1] in [CUSTOMIZE SCENE] is "0".

[CHROMA PHASE]

Adjusts color balance.

- 1 Touch [CHROMA PHASE].
- 2 Touch  /  to adjust settings.
 - You can select a value between -31 and +31.
- 3 Touch [EXIT] to exit the menu screen.

-
- The default setting that is assigned to [SCENE1] in [CUSTOMIZE SCENE] is "0".

[MATRIX]

Represents the color during the recording.

- 1 Touch [MATRIX].
- 2 Touch the desired setting item.

[NORM1]:	Suitable for recording in the open air or under a halogen lamp.
[NORM2]:	Suitable for brighter colors than the [NORM1] mode.
[FLUO]:	Suitable for recording indoors under fluorescent lamp.
[CINE-LIKE]:	Suitable for cinema-like image.

- 3 Touch [EXIT] to exit the menu screen.

[COLOR CORRECTION SETTING]

This function sets color saturation and phase. It applies individual effect on 16 phases in an image. It can be set to individual color hue.

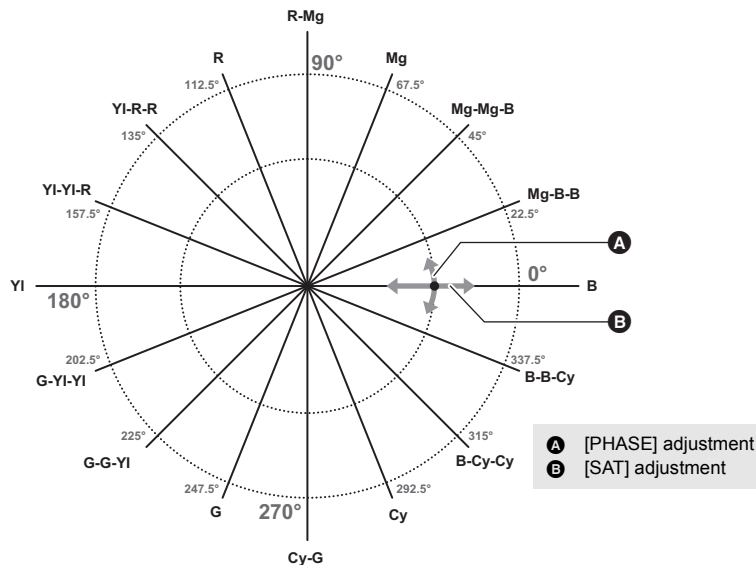



- 1 Touch [COLOR CORRECTION SETTING].
- 2 Touch the phase you want to set.

[R]/[R-Mg]/[Mg]/[Mg-Mg-B]/[Mg-B-B]/[B]/[B-B-Cy]/
[B-Cy-Cy]/[Cy]/[Cy-G]/[G]/[G-G-YI]/[G-YI-YI]/[YI]/
[YI-YI-R]/[YI-R-R]

- Next (Previous) page can be displayed by touching ▲ / ▼.
- 3 (To adjust the saturation)
Touch [SAT].
(To adjust the phase)
Touch [PHASE].
 - 4 Touch ◀ / ▶ to adjust settings.
 - You can select a value between -63 and +63.
 - (If you have touched [PHASE])
Making adjustments in the + direction corresponds to making adjustments clockwise in the diagram above. Conversely, making adjustments in the - direction corresponds to making adjustments counterclockwise in the diagram.
 - 5 Touch [RETURN].
 - Touch [EXIT] to exit the menu screen.

[MASTER PED]

Adjustment of black level based on the image is performed.

- 1 Touch **[MASTER PED]**.
- 2 Touch  /  to adjust the black level.
 - You can select a value between -150 and +150.
- 3 Touch **[EXIT]** to exit the menu screen.

- The default setting that is assigned to [SCENE1] in [CUSTOMIZE SCENE] is "0".

[GAMMA MODE]

Tone or contrast of the image is set in accordance with the recorded scenes.

- 1 Touch **[GAMMA MODE]**.
- 2 Touch the desired setting item.



[HD]:	This is the video gamma feature for HD (High Definition).
[SD]:	This increases gain in darker areas more than [HD] does.
[FILMLIKE1]:	This feature reproduces highlight areas more than [HD] does.
[FILMLIKE2]:	This feature reproduces highlight areas more than [FILMLIKE1] does.
[FILMLIKE3]:	This feature reproduces highlight areas more than [FILMLIKE2] does.
[CINE-LIKE V]:	This gamma feature creates cinematic images with sharper contrast.
[CINE-LIKE D]:	This gamma feature creates cinematic images.

- 3 Touch **[EXIT]** to exit the menu screen.

- When [CINE-LIKE V] or [CINE-LIKE D] is selected, we recommend that you set the lens aperture to a level lower than the normal lens iris level (approximately 1/2) to fully utilize the feature of the selected setting.

[BLACK GAMMA]

This sets the gamma curve of dark areas.

- 1 Touch **[BLACK GAMMA]**.
- 2 Touch  /  to adjust settings.
 - You can select a value between -8 and +8.
 - Making adjustments in the - direction compresses dark areas, while making adjustments in the + direction expands them.
- 3 Touch **[EXIT]** to complete the setting.

- The default setting that is assigned to [SCENE1] in [CUSTOMIZE SCENE] is "0".

[BLACK GAMMA RANGE]

This sets the upper limit on the compression/expansion of the [BLACK GAMMA] setting.

- 1 Touch **[BLACK GAMMA RANGE]**.
- 2 Touch the desired setting item.

[1] (approx. 20%)/[2] (approx. 30%)/[3] (approx. 40%)

- 3 Touch **[EXIT]** to exit the menu screen.

[KNEE MODE]

To avoid overexposure, select the compression level of the high intensity video signals received through the image sensor.

- 1 Touch **[KNEE MODE]**.
- 2 Touch the desired setting item.

[AUTO]: Sets the level automatically according to the signals received.



[MANUAL]: Applies the [KNEE MASTER POINT] and [KNEE MASTER SLOPE] settings.

[OFF]: Disables the Knee function.

- 3 Touch **[EXIT]** to exit the menu screen.

[KNEE MASTER POINT]



This adjusts the knee point position in 0.5% steps when [KNEE MODE] is set to [MANUAL].

- 1 Touch **[KNEE MASTER POINT]**.
- 2 Touch  /  to adjust settings.
 - You can select a value between 80.0 and 107.0.
- 3 Touch **[EXIT]** to exit the menu screen.

- The default setting that is assigned to [SCENE1] in [CUSTOMIZE SCENE] is "93.0".

[KNEE MASTER SLOPE]

This sets the knee inclination when [KNEE MODE] is set to [MANUAL].

- 1 Touch **[KNEE MASTER SLOPE]**.
- 2 Touch  /  to adjust settings.
 - You can select a value between 0 and 99.
- 3 Touch **[EXIT]** to exit the menu screen.

- The default setting that is assigned to [SCENE1] in [CUSTOMIZE SCENE] is “85”.

[DRS]

[ON]/[OFF]

Selects the DRS (Dynamic Range Stretcher) function. (→ 81)

[DRS EFFECT]

Selects the level of the DRS function.

- 1 Touch **[DRS EFFECT]**.
- 2 Touch the desired setting item.

[1]/[2]/[3]

- Higher the value, greater the compression level of the highly illuminated area.
 - Higher the value, greater the noise of the dark area.
- 3 Touch **[EXIT]** to exit the menu screen.

[AUTO IRIS LEVEL]

[ON]/[OFF]

This enables/disables Auto Iris Level. (→ 60)

[AUTO IRIS LEVEL EFFECT]

Adjusting brightness during the Auto Iris Mode. (→ 60)

- The default setting that is assigned to [SCENE1] in [CUSTOMIZE SCENE] is “0”.

[V-Log L MODE]

[ON]/[OFF]

When this item is set to [ON], V-Log L (12 stops) allows you to record expressive images with greater latitude.

- Images recorded in this mode are suitable for color grading.

-
- The following menu items are not available when [V-Log L MODE] is set to [ON]:

- [SCENE FILE] (→ 89, 140)
- [MASTER DETAIL] (→ 141)
- [DETAIL CORING] (→ 142)
- [SKIN TONE DTL] (→ 142)
- [V DETAIL LEVEL] (→ 142)
- [KNEE APE LEVEL] (→ 143)
- [RB GAIN CONTROL SETTING] (→ 143)
- [CHROMA LEVEL] (→ 144)
- [CHROMA PHASE] (→ 144)
- [MATRIX] (→ 144)
- [COLOR CORRECTION SETTING] (→ 145)
- [MASTER PED] (→ 146)
- [GAMMA MODE] (→ 146)
- [BLACK GAMMA] (→ 147)
- [BLACK GAMMA RANGE] (→ 147)
- [KNEE MODE] (→ 147)
- [KNEE MASTER POINT] (→ 147)
- [KNEE MASTER SLOPE] (→ 148)
- [DRS] (→ 81, 148)
- [DRS EFFECT] (→ 148)
- [HIGH SENS. MODE] (→ 158)

[FLASH BAND COMPENSATION]

[ON]/[OFF]

If you set this item to [ON], you can compensate for and reduce flash band, a phenomenon that creates markedly different levels of luminance between the top and bottom of the image when recording is performed in an environment where another camera is firing its flash. (→ 86)

-
- This function's default setting is [OFF].

System mode



All default settings are indicated with underlined text.

 : **[SYSTEM MODE]** → **desired setting**

[SYSTEM FREQ]

Set the system frequency of this unit.

[59.94Hz]:	System frequency for regions where the TV broadcasting system is NTSC
[50.00Hz]:	System frequency for regions where the TV broadcasting system is PAL

- After you have changed the system frequency, this unit will be restarted automatically.
- By default, the system frequency is set to the broadcasting system of the region where this product was purchased.
AG-DVX200PJ/PB/PX: This function's default setting is [59.94Hz].
AG-DVX200EJ/EN/ED: This function's default setting is [50.00Hz].
- When recording with [REC MODE] set to [AVCHD], you cannot record scenes of different system frequencies into a single SD card. Use a different SD card for each system frequency.

[OUTPUT BITS]

[4:2:2(10bit)]/[4:2:2(8bit)]

You can change the picture quality of images to be output to an external device according to the recording method used. (→ 31)

[REC MODE]

Switch the recording mode of the motion pictures to record.

- Set [OUTPUT BITS] to [4:2:2(8bit)].

[MOV]*:	This recording method is suitable for editing images. Motion pictures will be saved in MOV format.
[MP4]*:	This recording method is suitable for editing images. Motion pictures will be saved in MP4 format.
[AVCHD]:	This recording method is suitable for playback on a high-definition compatible external monitor.

* It is not compatible with motion pictures recorded in AVCHD.

- This function is not available in the following cases:
 - When [OUTPUT BITS] is set to [4:2:2(10bit)]
 - In Variable Frame Rate Mode (→ 91)
 - During the Interval Recording (→ 173)
 - During Freeze Frame (→ 81)

[REC FORMAT]

Switch the picture quality of motion pictures to be recorded with this unit.

Depending on the settings of [SYSTEM FREQ] (→ 150) and [REC MODE], the available [REC FORMAT] settings differ.

How to read a [REC FORMAT] setting

Items that make up a [REC FORMAT] setting represent Size, Vertical resolution, Frame rate, and Bit rate. (Excluding the [REC FORMAT] settings that are available when [REC MODE] is set to [AVCHD])

A UHD **B** 2160 / **C** 59.94p **D** 150M

- | | |
|------------------------------|---------------------|
| A Size | C Frame rate |
| B Vertical resolution | D Bit rate |

- Smoother motion picture can be recorded with the higher value for the frame rate. [i] and [p] of the frame rate means interlace and progressive respectively.

Interlace (interlacing scanning)

Video signal that divides the effective scanning lines to half and send them alternatively

Progressive (progressive scanning)

High density video signal sending the effective scanning lines simultaneously (It will be higher quality image than the interlace.)

- The higher the bit rate value is, the higher the picture quality becomes, except for when the recording format is $\frac{ALL-I}{200M}$ (This exception is due to a difference in compression method).
- It can record with highest quality image in this unit when set to [UHD 2160/59.94p 150M] or [UHD 2160/50.00p 150M].
- Recording with a [REC FORMAT] setting indicated with $\frac{FastScan}{100M}$ allows you to reduce the distortion of fast-moving subjects, although the angle of view becomes narrower.
- When the recording format is $\frac{ALL-I}{200M}$, recording is performed with ALL-Intra. ALL-Intra is a compression method that compresses each frame. This method results in larger file sizes, but it can minimize the deterioration in picture quality that occurs during editing.
- Depending on the [REC MODE] setting and the bit rate of the [REC FORMAT] setting, its required Speed Class of the SD card differs. Use an SD card that meets the settings. For details, refer to "About the Speed Class ratings for recording motion pictures" on page 21.

- Set [OUTPUT BITS] to [4:2:2(8bit)]. (→ 31)
- When [MOV] or [MP4] in [REC MODE] is selected

Recording format	System frequency setting	Size (Picture size)	Frame rate	Bit rate (VBR)
[4K 2160/24.00p 100M]	[59.94Hz]/ [50.00Hz]	4K (4096×2160)	24.00p	Average 100 Mbps
[4K 2160/24.00p ^{FastScan} _{100M}]				
[UHD 2160/59.94p 150M]	[59.94Hz]	UHD (3840×2160)	59.94p	Average 150 Mbps
[UHD 2160/29.97p 100M]			29.97p	Average 100 Mbps
[UHD 2160/29.97p ^{FastScan} _{100M}]				
[UHD 2160/23.98p 100M]				
[UHD 2160/23.98p ^{FastScan} _{100M}]			23.98p	Average 100 Mbps
[FHD 1080/59.94p ^{ALL-I} _{200M}]				
[FHD 1080/59.94p 100M]		Average 100 Mbps		
[FHD 1080/59.94p 50M]		Average 50 Mbps		
[FHD 1080/29.97p ^{ALL-I} _{200M}]		FHD (1920×1080)	29.97p	Average 200 Mbps
[FHD 1080/23.98p ^{ALL-I} _{200M}]			23.98p	
[FHD 1080/29.97p 50M]			29.97p	Average 50 Mbps
[FHD 1080/23.98p 50M]			23.98p	
[FHD 1080/59.94i 50M]			59.94i	
[UHD 2160/50.00p 150M]			[50.00Hz]	UHD (3840×2160)
[UHD 2160/25.00p 100M]	25.00p	Average 100 Mbps		
[UHD 2160/25.00p ^{FastScan} _{100M}]		FHD (1920×1080)		50.00p
[FHD 1080/50.00p ^{ALL-I} _{200M}]	Average 100 Mbps			
[FHD 1080/50.00p 100M]	Average 50 Mbps			
[FHD 1080/50.00p 50M]	25.00p			Average 200 Mbps
[FHD 1080/25.00p ^{ALL-I} _{200M}]				Average 50 Mbps
[FHD 1080/25.00p 50M]				
[FHD 1080/50.00i 50M]	50.00i	Average 50 Mbps		

● When [AVCHD] in [REC MODE] is selected

Recording format	System frequency setting	Picture size	Frame rate	Bit rate (VBR)	
[PS 1080/59.94p]	[59.94Hz]	1920×1080	59.94p	Average 25 Mbps	
[PH 1080/59.94i]			59.94i	Average 21 Mbps	
[PH 1080/23.98p]			23.98p		
[HA 1080/59.94i]				59.94i	Average 17 Mbps
[HE 1080/59.94i]			1440×1080		Average 5 Mbps
[PM 720/59.94p]			1280×720	59.94p	Average 8 Mbps
[SA 480/59.94i]			720×480	59.94i	Average 9 Mbps
[PS 1080/50.00p]	[50.00Hz]	1920×1080	50.00p	Average 25 Mbps	
[PH 1080/50.00i]			50.00i	Average 21 Mbps	
[HA 1080/50.00i]		Average 17 Mbps			
[HE 1080/50.00i]			1440×1080		Average 5 Mbps
[PM 720/50.00p]			1280×720	50.00p	Average 8 Mbps
[SA 576/50.00i]			720×576	50.00i	Average 9 Mbps

● **Recordable time using the battery (→ 18)**

- The system frequency is set to 24.00 Hz when [REC FORMAT] is set to a setting with a frame rate of 24.00p.
- When the default setting for [SYSTEM FREQ] is [59.94Hz]:
The default setting for [REC MODE] is [MP4], and the default setting for [REC FORMAT] is [UHD 2160/59.94p 150M].
When the default setting for [SYSTEM FREQ] is [50.00Hz]:
The default setting for [REC MODE] is [MP4], and the default setting for [REC FORMAT] is [UHD 2160/50.00p 150M].
- This item cannot be set in the following cases:
 - When [OUTPUT BITS] is set to [4:2:2(10bit)]
 - During the Interval Recording (→ 173)
 - During Freeze Frame (→ 81)
- The following [REC FORMAT] settings are available when [2 SLOTS FUNC.] is set to [BACKGROUND] (→ 170):
 - [FHD 1080/59.94p 50M]/[FHD 1080/29.97p 50M]/[FHD 1080/23.98p 50M]/[FHD 1080/59.94i 50M]/[FHD 1080/50.00p 50M]/[FHD 1080/25.00p 50M]/[FHD 1080/50.00i 50M]
- The following [REC FORMAT] settings are available in Variable Frame Rate Mode (→ 91):
 - [FHD 1080/59.94p 50M]/[FHD 1080/29.97p 50M]/[FHD 1080/23.98p 50M]/[FHD 1080/50.00p 50M]/[FHD 1080/25.00p 50M]
- Please refer to page 215 about approximate recordable time.
- When any of the following [REC FORMAT] settings is selected, the angle of view will change.
 - [4K 2160/24.00p 100M]/[4K 2160/24.00p ^{FastScan}100M]
 - [UHD 2160/59.94p 150M]/[UHD 2160/50.00p 150M]/[UHD 2160/29.97p ^{FastScan}100M]/[UHD 2160/23.98p ^{FastScan}100M]/[UHD 2160/25.00p ^{FastScan}100M]
 - [REC FORMAT] settings with a size of FHD (1920×1080)

- When the unit is moved a lot or moved quickly, or when a fast-moving subject is recorded, mosaic-type noise may appear at playback. (Only when recording AVCHD scenes)
- In the following cases, this unit will be restarted to switch the system frequency:
 - When you change the [REC FORMAT] setting from a setting with a frame rate of 24.00p to a setting with a different frame rate
 - When you change the [REC FORMAT] setting from a setting with a frame rate other than 24.00p to a setting with a frame rate of 24.00p

About recording formats and recording functions

The relationship between recording formats and recording functions of this unit are shown below.

- “○”: Available; “—”: Not available*

* “Not available” includes instances where the desired function cannot be used or selected.

Recording format	Recording function						
	Normal recording	Interval Rec (→ 173)	VFR Mode (→ 91, 140)	Relay recording (→ 170)	Simultaneous recording (→ 171)	Background recording (→ 171)	Dual codec recording (→ 171, 172)
[4K 2160/24.00p 100M]	○	○	—	○	○	—	—
[4K 2160/24.00p FastScan 100M]	○	—	—	○	○	—	—
[UHD 2160/59.94p 150M]	○	—	—	○	○	—	—
[UHD 2160/50.00p 150M]	○	—	—	○	○	—	—
[UHD 2160/29.97p 100M]	○	○	—	○	○	—	○
[UHD 2160/25.00p 100M]	○	○	—	○	○	—	○
[UHD 2160/23.98p 100M]	○	—	—	○	○	—	○
[UHD 2160/29.97p FastScan 100M]	○	—	—	○	○	—	○
[UHD 2160/25.00p FastScan 100M]	○	—	—	○	○	—	○
[UHD 2160/23.98p FastScan 100M]	○	—	—	○	○	—	○
[FHD 1080/59.94p ALL-I 200M]	○	—	—	○	○	—	○
[FHD 1080/50.00p ALL-I 200M]	○	—	—	○	○	—	○

Recording format	Recording function						
	Normal recording	Interval Rec (→ 173)	VFR Mode (→ 91, 140)	Relay recording (→ 170)	Simultaneous recording (→ 171)	Background recording (→ 171)	Dual codec recording (→ 171, 172)
[FHD 1080/29.97p _{ALL-I 200M}]	○	—	—	○	○	—	○
[FHD 1080/25.00p _{ALL-I 200M}]	○	—	—	○	○	—	○
[FHD 1080/23.98p _{ALL-I 200M}]	○	—	—	○	○	—	○
[FHD 1080/59.94p 100M]	○	—	—	○	○	—	○
[FHD 1080/50.00p 100M]	○	—	—	○	○	—	○
[FHD 1080/59.94p 50M]	○	—	○	○	○	○	—
[FHD 1080/50.00p 50M]	○	—	○	○	○	○	—
[FHD 1080/29.97p 50M]	○	○	○	○	○	○	—
[FHD 1080/25.00p 50M]	○	○	○	○	○	○	—
[FHD 1080/23.98p 50M]	○	—	○	○	○	○	—
[FHD 1080/59.94i 50M]	○	—	—	○	○	○	—
[FHD 1080/50.00i 50M]	○	—	—	○	○	○	—
[PS 1080/59.94p]	○	—	—	○	○	○	—
[PS 1080/50.00p]	○	—	—	○	○	○	—
[PH 1080/59.94i]	○	—	—	○	○	○	—
[PH 1080/50.00i]	○	—	—	○	○	○	—
[PH 1080/23.98p]	○	—	—	○	○	○	—
[HA 1080/59.94i]	○	○	—	○	○	○	—
[HA 1080/50.00i]	○	○	—	○	○	○	—

Recording format	Recording function						
	Normal recording	Interval Rec (→ 173)	VFR Mode (→ 91, 140)	Relay recording (→ 170)	Simultaneous recording (→ 171)	Background recording (→ 171)	Dual codec recording (→ 171, 172)
[HE 1080/59.94i]	○	—	—	○	○	○	—
[HE 1080/50.00i]	○	—	—	○	○	○	—
[PM 720/59.94p]	○	—	—	○	○	○	—
[PM 720/50.00p]	○	—	—	○	○	○	—
[SA 480/59.94i]	○	—	—	○	○	○	—
[SA 576/50.00i]	○	—	—	○	○	○	—

[OUTPUT FORMAT]

This changes the picture quality of images to be output to an external device. The available [OUTPUT FORMAT] vary depending on the [SYSTEM FREQ] (→ 150) setting.

- Outputting images with an [OUTPUT FORMAT] setting indicated with *FastScan* allows you to reduce the distortion of fast-moving subjects during recording, although the angle of view becomes narrower.
- Set [OUTPUT BITS] to [4:2:2(10bit)]. (→ 31)

[OUTPUT FORMAT]	System frequency setting	Size (Picture size)	Frame rate	
[4K 2160/24.00p]	59.94Hz/ 50.00Hz	4K (4096×2160)	24.00p	
[4K 2160/24.00p <i>FastScan</i>]				
[UHD 2160/29.97p]	59.94Hz	UHD (3840×2160)	29.97p	
[UHD 2160/29.97p <i>FastScan</i>]			23.98p	
[UHD 2160/23.98p]			FHD(1920×1080)	59.94p
[UHD 2160/23.98p <i>FastScan</i>]				29.97p
[FHD 1080/59.94p]		23.98p		
[FHD 1080/29.97p]		59.94i		
[FHD 1080/23.98p]		50.00Hz	UHD (3840×2160)	25.00p
[FHD 1080/59.94i]				50.00p
[UHD 2160/25.00p]	FHD (1920×1080)		25.00p	
[UHD 2160/25.00p <i>FastScan</i>]			50.00i	
[FHD 1080/50.00p]				
[FHD 1080/25.00p]				
[FHD 1080/50.00i]				

- When the default setting for [SYSTEM FREQ] is [59.94Hz]:
This function's default setting is [UHD 2160/29.97p].
When the default setting for [SYSTEM FREQ] is [50.00Hz]:
This function's default setting is [UHD 2160/25.00p].
- The system frequency is set to 24.00 Hz when [OUTPUT FORMAT] is set to a setting with a frame rate of 24.00p.
- This unit restarts in the following situations to change the system frequency:
 - When you change the [OUTPUT FORMAT] setting from a setting with a frame rate of 24.00p to a setting with a different frame rate
 - When you change the [OUTPUT FORMAT] setting from a setting with a frame rate other than 24.00p to a setting with a frame rate of 24.00p
- This item cannot be set in the following cases:
 - When [OUTPUT BITS] is set to [4:2:2(8bit)]
 - During Freeze Frame (→ 81)

[ASPECT CONVERT]

This sets the aspect ratio of images to be recorded with a [REC FORMAT] setting of [SA 480/59.94i] or [SA 576/50.00i].

- Set [OUTPUT BITS] to [4:2:2(8bit)]. (→ 31)
- Set [REC FORMAT] to [SA 480/59.94i] or [SA 576/50.00i]. (→ 151)

[SIDE CROP]:	Records images in standard 4:3 mode. The sides will be cut off.
[LETTERBOX]:	Records images in the 16:9 aspect ratio. Black bands at the top and bottom of the picture will be recorded. Since the screen size of the viewfinder and LCD monitor of this unit is 16:9, black bands do not appear at their top and bottom.
[SQUEEZE]:	Records images by compressing images in the horizontal direction. When recorded images are played back on a wide-screen external monitor, they appear in the 16:9 aspect ratio.

- This function is not available in the following cases:
 - When [REC FORMAT] is set to an option other than [SA 480/59.94i] or [SA 576/50.00i] (→ 151)
 - When [OUTPUT BITS] is set to [4:2:2(10bit)]
 - During Freeze Frame (→ 81)

[EXTENDED SENSITIVITY]

[ON]/[OFF]

Setting this item to [ON] allows you to set a negative gain value. (→ 61)

- When this item is set to [ON], [HIGH SENS. MODE] is set to [NORMAL].

[HIGH SENS. MODE]



This sets the optimal recording mode for the recording environment.

[NORMAL]:	Select this setting when the light level of the recording environment is normal.
[HIGH SENS.]:	Select this setting when recording in a dark environment.

- [H.SENS] is displayed on the screen when [HIGH SENS.] is selected.
- This function is not available in the following cases:
 - In Variable Frame Rate Mode (→ 91)
 - During Freeze Frame (→ 81)
- [EXTENDED SENSITIVITY] will be set to [OFF] when [HIGH SENS.] is selected.

[CAMERA NUMBER SET]

This sets the camera number for this unit.

- 1 Touch **[CAMERA NUMBER SET]**.
- 2 Touch  /  to change the Camera Number.
 - Numbers between 0 and 9 can be set.
- 3 Touch **[RETURN]**.
 - Touch [EXIT] to exit the menu screen.

- This function's default setting is "0".

User switch

All default settings are indicated with underlined text.

 : **[USER SW]** → desired setting

[USER1]/[USER2]/[USER3]/[USER4]/ [USER5]/[USER6]/[USER7]/[USER8]/[AWB]



Sets the function to assign to the USER buttons. (→ 75)

- For the functions of the USER button that can be registered, refer to page 77.

- The default settings are as follows:

- | | |
|------------------------|----------------------|
| – USER1: [DRS] | – USER6: [ZEBRA] |
| – USER2: [ATW] | – USER7: [WFM] |
| – USER3: [BACKLIGHT] | – USER8: [REC CHECK] |
| – USER4: [FOCUS MACRO] | – AWB: [AWB] |
| – USER5: [O.I.S.] | |

[USER10]/[USER11]/[USER12]/[USER13]



Register functions to USER button icons. (→ 75)

- For the functions of the USER button that can be registered, refer to page 77.

- The default settings are as follows:

- | | |
|----------------------------|----------------------|
| – USER10: [FRZ FRAME] | – USER12: [ATW LOCK] |
| – USER11: [EVF/LCD DETAIL] | – USER13: [MENU] |

[USER BUTTON DISPLAY]



[ON]/[OFF]

Switches the display of the set USER button icons. (→ 76)

Switch setting



All default settings are indicated with underlined text.

MENU : [SW SETUP] → desired setting

[IRIS RING]

Sets the rotation direction and iris control of the iris ring.

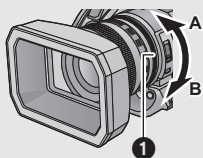

[DOWN OPEN]: Iris will open when it is turned toward B.

[UP OPEN]: Iris will open when it is turned toward A.

① Iris ring

[LOW GAIN]

Sets the gain value for the [L] position of the GAIN switch.

1 Touch [LOW GAIN].

2 Touch / to adjust settings.

- When [GAIN/ISO DISPLAY CHG] (→ 184) is set to [GAIN], you can select [AUTO] or a value between 0dB and 24dB.

When [EXTENDED SENSITIVITY] is set to [ON], you can set a value between -6dB and 24dB. (→ 158)

- When [GAIN/ISO DISPLAY CHG] is set to [ISO], you can select [AUTO] or a value between ISO500 and ISO8000.

When [EXTENDED SENSITIVITY] is set to [ON], you can set a value between ISO250 and ISO8000.

In High-Sensitivity Recording Mode, you can set a value between ISO1000 and ISO16000. (→ 158)

3 Touch [EXIT] to exit the menu screen.

- This function's default setting is "0dB".
- When a negative gain value (a value between -6dB and -1dB or ISO250 and ISO400) is selected, if you set [EXTENDED SENSITIVITY] to [OFF] and operate the GAIN switch, the gain value will be set to 0dB or ISO500. However, the [LOW GAIN] setting will be maintained.

[MID GAIN]

Sets the gain value for the [M] position of the GAIN switch.

1 Touch [MID GAIN].

2 Touch / to adjust settings.

- When [GAIN/ISO DISPLAY CHG] (→ 184) is set to [GAIN], you can select [AUTO] or a value between 0dB and 24dB.
When [EXTENDED SENSITIVITY] is set to [ON], you can set a value between -6dB and 24dB. (→ 158)
- When [GAIN/ISO DISPLAY CHG] is set to [ISO], you can select [AUTO] or a value between ISO500 and ISO8000.
When [EXTENDED SENSITIVITY] is set to [ON], you can set a value between ISO250 and ISO8000.
In High-Sensitivity Recording Mode, you can set a value between ISO1000 and ISO16000. (→ 158)

3 Touch [EXIT] to exit the menu screen.

-
- This function's default setting is "6dB".
 - When a negative gain value (a value between -6dB and -1dB or ISO250 and ISO400) is selected, if you set [EXTENDED SENSITIVITY] to [OFF] and operate the GAIN switch, the gain value will be set to 0dB or ISO500. However, the [MID GAIN] setting will be maintained.

[HIGH GAIN]

Sets the gain value for the [H] position of the GAIN switch.

1 Touch [HIGH GAIN].

2 Touch / to adjust settings.

- When [GAIN/ISO DISPLAY CHG] (→ 184) is set to [GAIN], you can select [AUTO] or a value between 0dB and 24dB.
When [EXTENDED SENSITIVITY] is set to [ON], you can set a value between -6dB and 24dB. (→ 158)
- When [GAIN/ISO DISPLAY CHG] is set to [ISO], you can select [AUTO] or a value between ISO500 and ISO8000.
When [EXTENDED SENSITIVITY] is set to [ON], you can set a value between ISO250 and ISO8000.
In High-Sensitivity Recording Mode, you can set a value between ISO1000 and ISO16000. (→ 158)

3 Touch [EXIT] to exit the menu screen.

-
- This function's default setting is "12dB".
 - When a negative gain value (a value between -6dB and -1dB or ISO250 and ISO400) is selected, if you set [EXTENDED SENSITIVITY] to [OFF] and operate the GAIN switch, the gain value will be set to 0dB or ISO500. However, the [HIGH GAIN] setting will be maintained.

[SUPER GAIN]

Sets the gain value for the USER button function [SUPER GAIN]. (→ 62)

- **Switch to Manual Mode.** (→ 36)

(When [GAIN/ISO DISPLAY CHG] (→ 184) is set to [GAIN])

[30 dB]/[36 dB]

(When [GAIN/ISO DISPLAY CHG] is set to [ISO])

[ISO16000]/[ISO32000]

[O.I.S.]

[ON]/[OFF]

This enables/disables the Image Stabilizer. (→ 42)

[HYBRID O.I.S.]

[ON]/[OFF]

You can set the Hybrid Optical Image Stabilizer. (→ 42)

[CUSTOM O.I.S.]

[ON]/[OFF]

When [ON] is selected, the Image Stabilizer works with customized [BLUR AMPLITUDE] and [BLUR FREQUENCY] settings. (→ 43)

[BLUR AMPLITUDE]

[1]/[2]/[3]/[4]/[5]

This sets the blur amplitude of the Image Stabilizer during recording. (→ 43)

[BLUR FREQUENCY]

[1]/[2]/[3]

This sets the blur frequency of the Image Stabilizer. (→ 43)

[ATW SET]

You can assign ATW to the WHITE BAL switch.

[OFF]:	Does not assign ATW to the WHITE BAL switch.
[Ach]:	Sets the White Balance mode to ATW when the WHITE BAL switch is set to A.
[Bch]:	Sets the White Balance mode to ATW when the WHITE BAL switch is set to B.
[PRST]:	Sets the White Balance mode to ATW when the WHITE BAL switch is set to PRST.

[ATW SPEED]

[FAST]/[NORMAL]/[SLOW]

This sets the control speed for ATW. (→ 57)

[ATW TARGET R]

This fine-adjusts the intensity of red. (→ 57)

- This function's default setting is "0".

[ATW TARGET B]

This fine-adjusts the intensity of blue. (→ 57)

- This function's default setting is "0".



[WB PRESET]

[3200K]/[5600K]/[VAR]

Sets which White Balance mode to use when the WHITE BAL switch is set to the PRST position.

[WB VAR]

Sets the color temperature when the White Balance mode is set to [VAR]. (→ 58)

- 1 Touch [WB VAR].
- 2 Touch  /  to adjust settings.
- 3 Touch [EXIT] to exit the menu screen.

- This function's default setting is [3200K].

[MF ASSIST]

[ON]/[OFF]

When [ON] is selected, focus is automatically adjusted after you adjust it with the focus ring in Manual Focus Mode. (→ 51)

[MF ASSIST MODE]

[CENTER AREA]/[MULTI AREA]

You can change the focus position setting for the automatic focus adjustment of MF Assist. (→ 52)

[FOCUS ASSIST 1]

[EXPAND]/[PEAKING]/[BOTH]

Sets the Focus Assist method for the FOCUS ASSIST button and the USER button to which [FOCUS ASSIST 1] is registered. (→ 48)

[FOCUS ASSIST 2]

Sets the Focus Assist method for the USER button to which [FOCUS ASSIST 2] is registered. (→ 48)

This item is not available when [FOCUS ASSIST 1] is set to [BOTH].

- Set [FOCUS ASSIST 1] to [EXPAND] or [PEAKING]

[EXPAND]/[PEAKING]

[PEAKING COLOR]

[Red]/[Blue]/[Yellow]/[White]

You can set the peaking color for Focus Assist. (→ 50)

[PEAKING LEVEL]

You can set the peaking strength for Focus Assist. (→ 50)

- This function's default setting is "0".

[FOCUS RING DRIVE]

[SPEED]/[COARSE]/[FINE]

This sets the way you adjust focus with the focus ring. (→ 45)

[FOCUS MACRO]

[ON]/[OFF]

This enables/disables the Focus Macro function.

- If [ON] is selected, subjects at a distance of approximately 10 cm (3.93 ") to infinity can be brought into focus when the zoom position is at the W end. (→ 40)

[A.IRIS SPEED]

[FAST]/[NORMAL]/[SLOW]

This sets the control speed in Auto Iris Mode. (→ 60)

[AREA MODE]

[INH]/[FOCUS]/[IRIS]/[Y GET]/[FOCUS/IRIS]/[FOCUS/Y GET]

You can set an Area Mode effect. (→ 82)

[CUSTOM AF]

[ON]/[OFF]

When [ON] is selected, Auto Focus works with customized [AF SPEED] and [AF SENSITIVITY] settings. (→ 46)

[AF SPEED]

You can adjust the focus speed of Auto Focus. (→ 46)

- This function's default setting is "0".

[AF SENSITIVITY]

You can adjust the tracking sensitivity of Auto Focus. (→ 46)

- This function's default setting is "5".

[AF AREA WIDTH]

You can adjust the effective area width for Auto Focus according to the size of the subject. (→ 47)

[WFM]

[ON]/[OFF]

This enables/disables the Wave Form Monitor function. (→ 87)

[WFM TYPE]

[WAVE]/[VECTOR]/[WAVE/VECTOR]

This sets the type of Wave Form Monitor. (→ 87)

[WFM POSITION]

[TOP/LEFT]/[TOP/RIGHT]/[BOTTOM/LEFT]/[BOTTOM/RIGHT]

This sets the display positions of Wave Form Monitor. (→ 87)

[ZEBRA]

[ZEBRA 1]/[ZEBRA 2]*/[MARKER]*/[OFF]

* Not displayed when [ZEBRA 2]/[MARKER] is set to [OFF]. (→ 182)

Switch between the zebra display and marker display.

- For information on the zebra display and marker display, refer to page 88.

[ZEBRA MODE]

This sets the display duration of the zebra display.

[CONTINUE]: Displays the zebra display until it is switched to another zebra display setting.

[MOMENT]: Displays the zebra display for approximately 5 seconds.

[BARS TYPE]

You can switch the type of color bars to be displayed when you press the BARS button. (→ 96)

[TYPE 1]	[TYPE 2]	[TYPE 3]
		

- When the default setting for [SYSTEM FREQ] is [59.94Hz]:
This function's default setting is [TYPE 1].
When the default setting for [SYSTEM FREQ] is [50.00Hz]:
This function's default setting is [TYPE 2].

[SUB REC BUTTON]

- Set [OUTPUT BITS] to [4:2:2(8bit)]. (→ 31)

[ACTIVE]/[INHIBIT]

Enable/disable of the sub recording start/stop button on the handle can be switched.

[FAST ZOOM]

[ON]/[OFF]

When [ON] is selected, you can use Fast Zoom when operating the zoom with the zoom lever. (→ 41)

[SUB ZOOM]

[OFF]/[1]/[2]/[3]/[4]/[5]/[6]/[7]

Enable/disable of the sub zoom lever on the handle can be switched. Zoom speed will be different depending on the setting.

- The larger the value is, the faster the zoom speed becomes, and vice versa.

[DIGITAL ZOOM]

[×2]/[×5]/[×10]/[TOGGLE]

Changes the zoom magnification setting of Digital Zoom. (→ 93)

[i.Zoom]

- Set [REC FORMAT] or [OUTPUT FORMAT] to a setting with a picture size of 1920×1080 or below. (→ 151, 157)

[ON]/[OFF]

You can zoom in while maintaining the beauty of high-definition picture quality up to a magnification of 20×. (→ 41)

[ZOOM/FOCUS]

You can switch between operating controls such as the zoom lever and focus ring with this unit and operating them with the AG ROP application during AG ROP application connection. (→ 138)

[IP REMOTE]/[CAMERA]

- Selecting [IP REMOTE] enables you to operate this unit with the AG ROP application, while selecting [CAMERA] enables you to operate this unit directly.

Auto switch setting



All default settings are indicated with underlined text.

 : [AUTO SW] → **desired setting**

[A.IRIS]

[ON]/[OFF]

This enables/disables Auto Iris for Auto Iris Mode. (→ 36)

[AGC]

[ON]/[OFF]

This enables/disables AGC for Auto Iris Mode. (→ 36)

[AGC LIMIT]

Sets the maximum possible gain value for Auto Gain Mode. (→ 62)
(When [GAIN/ISO DISPLAY CHG] is set to [GAIN])

[3 dB]/[6 dB]/[9 dB]/[12 dB]/[15 dB]/[18 dB]/[21 dB]/[24 dB]

(When [GAIN/ISO DISPLAY CHG] is set to [ISO])

[ISO1000]/[ISO2000]/[ISO4000]/[ISO8000]

- Settings available in High-sensitivity Recording Mode are [ISO2000], [ISO4000], [ISO8000], and [ISO16000]. (→ 158)

[AUTO SHUTTER]

[ON]/[OFF]

This enables/disables Auto Shutter for Auto Mode. (→ 36)

[AUTO SHUTTER LIMIT]

[1/100]/[1/120]*¹/[1/125]*²/[1/250]/[OFF]

*1 This option is not displayed when [SYSTEM FREQ] is set to [50.00Hz].

*2 This option is not displayed when [SYSTEM FREQ] is set to [59.94Hz].

This sets the upper limit on the shutter speed for Auto Shutter Mode. (→ 65)

[AUTO SLOW SHTR]

[ON]/[OFF]

You can record bright pictures even in dark places by slowing the shutter speed.

Slow Shutter works in Auto Shutter Mode. (→ 64)

- The shutter speed will be adjusted to one of the following values according to the ambient brightness. The value will differ depending on the frame rate of the [REC FORMAT] or [OUTPUT FORMAT].

Frame rates	Shutter speed
59.94p/59.94i/29.97p	1/30 or more
50.00p/50.00i/25.00p	1/25 or more
23.98p/24.00p	1/24 or more

- This item cannot be set during Freeze Frame. (→ 81)

- When the shutter speed becomes 1/30, 1/24 or 1/25, the screen may be seen as if frames are missed and after images may appear.

[ATW]

[ON]/[OFF]

This enables/disables ATW for Auto Mode. (→ 36)

[AF]

[ON]/[OFF]

This enables/disables Auto Focus for Auto Mode. (→ 36)

Recording Setup



All default settings are indicated with underlined text.

 : **[RECORD SETUP]** → **desired setting**

[MEDIA SELECT]

- Set **[OUTPUT BITS]** to **[4:2:2(8bit)]**. (→ 31)

[SD CARD 1] and [SD CARD 2] can be selected separately to record motion pictures or still pictures. (→ 32)

[2 SLOTS FUNC.]

You can set relay/simultaneous/background/dual codec recording.

- Set **[OUTPUT BITS]** to **[4:2:2(8bit)]**. (→ 31)
- Insert SD cards to card slot 1 and card slot 2.

[OFF]:	Cancel the setting.
[RELAY REC]^{*1}:	Set the relay recording
[SIMULTANEOUS]^{*2}:	Set the simultaneous recording
[BACKGROUND]^{*1, 3}:	Set the background recording
[DUAL CODEC]^{*1, 2, 4}:	Set the dual codec recording

*1 This function is not available in the following cases:

- In Variable Frame Rate Mode (→ 91)
- During the Interval Recording (→ 173)

*2 This item is not available when different types of SD cards (SDHC Memory Card/SDXC Memory Card) are used.

*3 This function is not available in the following cases:

- When [REC FORMAT] is set to a setting with a size of 4K (4096×2160) or UHD (3840×2160) (→ 151)
- When the bit rate of [REC FORMAT] is above 50 Mbps

*4 Set [REC FORMAT] to a setting that allows you to use dual codec recording. (→ 173)

■ Relay recording

This is simple Relay Recording. It is possible to continuously record on the SD card in the other card slot even when the available capacity of the SD card runs out during the recording.

- **[RELAY]** is displayed beside the display of the SD card selected as the recording destination of motion pictures in [MEDIA SELECT] (→ 32). When the recording media is switched and Relay Recording starts, **[RELAY]** will disappear from the location and instead be displayed beside the other SD card display.
- Even after switching of the recording media, you can replace the SD card that ran out of space with a new one and record the motion picture onto three or more SD cards. Since it may take a while for this unit to recognize a new SD card, replace the SD card that ran out of space when the SD card currently being used as a destination still has sufficient remaining recordable time.

■ Simultaneous recording

Same motion picture can be recorded on two SD cards.

- [SIMUL] is displayed beside the display of the SD card selected as the recording destination of motion pictures in [MEDIA SELECT] (→ 32).
- If you set the recording destination of motion pictures to [SD CARD 1] in [MEDIA SELECT], they will also be recorded to [SD CARD 2] simultaneously.
- We recommend that you perform simultaneous recording using SD cards of the same Speed Class rating and capacity.

■ Background recording

You can continue recording a motion picture by recording it on the SD card that is not set as a recording destination in [MEDIA SELECT] (→ 32).

- When the recording destination of motion pictures is set to [SD CARD 1] in [MEDIA SELECT], [SD CARD 2] will be used for background recording. The following instructions assume that the recording destination of motion pictures is set to [SD CARD 1].
- [BACKGR] is displayed beside the SD card display for card 2.

How to use background recording

- Register [BACKGROUND] to a USER button. (→ 75)

1 Press the recording start/stop button to start recording.

- A motion picture will start being recorded to the two SD cards. ([BACKGR] will be displayed in red.)
- If you press the USER button to which [BACKGROUND] is registered, you can start recording only to the SD card in card slot 2.
- For information on how to register a function to USER buttons, refer to page 75. For information on how to use the USER button to which [BACKGROUND] is registered, refer to page 85.

2 Press the recording start/stop button again to stop recording.

- Recording to the SD card in card slot 1 will stop, but recording to the SD card in card slot 2 will continue.
- You can repeat recording to the SD card in card slot 1 by pressing the recording start/stop button.
- You can stop background recording by pressing and holding the USER button to which [BACKGROUND] is registered.

■ Dual codec recording

You can make main and sub recordings in separate [REC FORMAT] settings.

Sub recording records scenes in a picture quality lower than that of the [REC FORMAT] setting for main recording.

- If you set the recording destination of motion picture to [SD CARD 1] in [MEDIA SELECT] (→ 32), [SD CARD 1] will be used for main recording, while [SD CARD 2] will be used for sub recording.
- Set the sub recording scene setting in [DUAL CODEC REC].
- The icon for the card used for main recording will be displayed with [DUAL 50M] or [DUAL 8M].

- [2 SLOTS FUNC.] is not available when [OUTPUT BITS] is set to [4:2:2(10bit)].

(Relay recording)

- Destination to record still pictures will be switched to other SD card after performing the relay recording. In addition, a message about the remaining card capacity will be displayed. Replace the SD card that ran out of space or set [2 SLOTS FUNC.] to [OFF].

(Simultaneous recording)

- Simultaneous recording will not be performed for still pictures.
- When performing simultaneous recording, even in the case where an error has occurred in one of the SD cards and recording has stopped, recording can be continued using the other SD card.
- When one of the media reaches its maximum recording time, the simultaneous recording stops.

(Background recording)

- An alert sound is not emitted for background recording.
- If you record still pictures, their picture quality will differ from that during normal still picture recording.
- Background recording stops in the following cases:
 - When you have turned off this unit
 - When the SD card being used as a background recording destination runs out of space
- If the SD card being used as a background recording destination runs out of space during motion picture recording, background recording does not restart automatically even if you replace the SD card.

(Dual codec recording)

- Main recording does not stop even if an error occurs in the memory card used for sub recording. If an error occurs in the memory card used for main recording, the recording stops.

[DUAL CODEC REC]

This sets the sub recording scene settings for dual codec recording.

- For information on dual codec recording, refer to page 171.
- Set [OUTPUT BITS] to [4:2:2(8bit)]. (→ 31)
- Set [REC FORMAT] to a setting with a size of UHD (3840×2160). (→ 151)

[FHD 50Mbps]: Performs recording at a bit rate of 50Mbps. Scenes can be saved in either MOV or MP4 format.

[FHD 8Mbps]: Performs recording at a bit rate of 8Mbps. Scenes can be saved in MOV format.

- Sub recording scenes will be recorded with the following settings:
 - Recording is performed with a size setting of FHD (1920×1080)
 - When [FHD 50Mbps] is selected, the [REC MODE] setting selected for sub recording will be the same as the setting selected for main recording (MOV/MP4).
 - Recording is performed at the same frame rate as that of the [REC FORMAT] setting for main recording.

■ [REC FORMAT] settings that support main recording of dual codec recording

(When [DUAL CODEC REC] is set to [FHD 50Mbps])

Recording mode	System frequency setting	Recording format
MOV, MP4	[59.94Hz]	UHD 2160/29.97p 100M, UHD 2160/29.97p ^{FastScan} 100M , UHD 2160/23.98p 100M, UHD 2160/23.98p ^{FastScan} 100M
	[50.00Hz]	UHD 2160/25.00p 100M, UHD 2160/25.00p ^{FastScan} 100M

(When [DUAL CODEC REC] is set to [FHD 8Mbps])

Recording mode	System frequency setting	Recording format
MOV, MP4	[59.94Hz]	UHD 2160/29.97p 100M, UHD 2160/29.97p ^{FastScan} 100M , UHD 2160/23.98p 100M, UHD 2160/23.98p ^{FastScan} 100M , FHD 1080/59.94p ^{ALL-I} 200M, FHD 1080/59.94p 100M, FHD 1080/29.97p ^{ALL-I} 200M , FHD 1080/23.98p ^{ALL-I} 200M
	[50.00Hz]	UHD 2160/25.00p 100M, UHD 2160/25.00p ^{FastScan} 100M , FHD 1080/50.00p ^{ALL-I} 200M, FHD 1080/50.00p 100M, FHD 1080/25.00p ^{ALL-I} 200M

● This function is not available in the following cases:

- When [OUTPUT BITS] is set to [4:2:2(10bit)]
- In Variable Frame Rate Mode (→ 91)
- When [REC MODE] is set to [AVCHD] (→ 150)
- When the size of [REC FORMAT] is set an option other than UHD (3840×2160)
- During the Interval Recording (→ 173)

[INTERVAL REC]

A scene that moves slowly for long period of time is recorded frame by frame with an interval, and is recorded as a short time motion picture.

One frame is recorded every recording interval that is set.

● The number of frames per second differs depending on the frame rate of [REC FORMAT].

- When the frame rate is set to 59.94i or 29.97p: 30 frames for a scene of 1 second
- When the frame rate is set to 50.00i or 25.00p: 25 frames for a scene of 1 second
- When the frame rate is set to 24.00p or 23.98p: 24 frames for a scene of 1 second

● Set [OUTPUT BITS] to [4:2:2(8bit)]. (→ 31)

[OFF]/[1 SEC.]/[10 SEC.]/[30 SEC.]/[1 MINUTE]/[2 MINUTES]

- [I-] is displayed on the screen. The icon changes to [I-REC] after recording starts.
- After recording, the setting of Interval Recording is canceled.
- Audio cannot be recorded.

Setup example	Setup time (recording interval)	Recording time	Recorded time
Sunset	1 s	1 h	2 min
Blooming	30 s	3 h	12 s

- "h" is an abbreviation for hour, "min" for minute and "s" for second.
- These times are approximations.
- Maximum recordable time is 168 hours.

-
- Still picture recording cannot be used.
 - This function is not available in the following cases:
 - When [OUTPUT BITS] is set to [4:2:2(10bit)]
 - During Freeze Frame (→ 81)
 - PRE-REC is used (→ 86)
 - In Variable Frame Rate Mode (→ 91)
 - When Interval Recording is set, the [REC FORMAT] setting changes as follows. In addition, the settings for [REC MODE] and [REC FORMAT] cannot be changed.
 - When the size of the [REC FORMAT] setting is 4K (4096×2160):
[4K 2160/24.00p 100M]
 - When the size of the [REC FORMAT] setting is UHD (3840×2160):
[UHD 2160/29.97p 100M]^{*1} or [UHD 2160/25.00p 100M]^{*2}
 - When the size of the [REC FORMAT] setting is FHD (1920×1080):
[FHD 1080/29.97p 50M]^{*1} or [FHD 1080/25.00p 50M]^{*2}
 - When [REC FORMAT] is set to [AVCHD]:
[HA 1080/59.94i]^{*1} or [HA 1080/50.00i]^{*2}
- *1 When [SYSTEM FREQ] (→ 150) is set to [59.94Hz]
 *2 When [SYSTEM FREQ] is set to [50.00Hz]
- [INTERVAL REC] is canceled in the following cases.
 - If you turn the unit off
 - If you press the THUMBNAIL button
 - When [USB MODE SELECT] is set to [DEVICE] and this unit is connected to a PC. (→ 123)
 - The shortest motion picture recording time is approx. 2 second.
 - Color balance and focus may not be adjusted automatically depending on light sources or scenes. If so, manually adjust these settings. (→ 44, 55)
 - We recommend connecting the AC adaptor to this unit when recording images for a long period of time.

[PRE-REC]

- Set [OUTPUT BITS] to [4:2:2(8bit)]. (→ 31)

[ON]/[OFF]

This allows the recording of an image and audio to start before you press the recording start/stop button. AVCHD scenes will be recorded from approximately 3 seconds before the operation, while MOV/MP4 will be recorded from approximately 4 seconds before the operation. (→ 86)

[INFRARED REC]

[ON]/[OFF]

Selecting [ON] enables Infrared Recording Mode, allowing you to record images in the dark. (→ 84)

[FOCUS TRANSITION]

- Switch to Manual Focus. (→ 44)

[SET]/[OFF]

You can register a focus position to Focus Transition. (→ 52)

[FOCUS TRANSITION TIME]

[DIRECT]/[FASTEST]/[2-15 SEC.]/[20 SEC.]/[30 SEC.]/[45 SEC.]/[60 SEC.]/[90 SEC.]

You can set the length of time in which the focus will shift during Focus Transition. (→ 54)

- This function's default setting is 2 seconds.

[FOCUS TRANSITION REC]

[1]/[2]/[3]/[OFF]

You can start recording and Focus Transition simultaneously. (→ 54)

[FOCUS TRANSITION WAIT]

[0 SEC.]/[5 SEC.]/[10 SEC.]

You can set the length of time before Focus Transition starts. (→ 55)

[TIME STAMP]

- Set [OUTPUT BITS] to [4:2:2(8bit)]. (→ 31)

[ON]/[OFF]

You can stamp the date and time of recording on the images you record.

- **R** appears on the screen.
- The display mode and format of the date and time of recording to be stamped vary depending on the settings for [DATE/TIME] and [DATE FORMAT]. (→ 184)
- The month of the date and time of recording is recorded in English.

- In the following cases, even when [TIME STAMP] is set to [ON], the date and time of recording are not displayed:
 - When [OUTPUT BITS] is set to [4:2:2(10bit)]
 - When [REC FORMAT] is set to [SA 480/59.94i] or [SA 576/50.00i] (→ 151)
 - When [2 SLOTS FUNC.] is set to [DUAL CODEC] (→ 170)
 - When [DATE/TIME] is set to [OFF]
 - During Freeze Frame (→ 81)
 - In Variable Frame Rate Mode (→ 91)
 - When this unit is connected to the SDI OUT terminal of the external device and the external output resolution is set to PsF (→ 117)
- Even when [VIDEO OUT OSD] is set to [OFF], the date and time of recording are displayed on the external monitor screen. (→ 116)
- It is not possible to stamp the date and time of recording during normal still picture recording.
- The date and time of recording displayed during [TIME STAMP] recording and the date and time displayed during the playback of the image may not exactly be the same.

[DF MODE]

- Set [SYSTEM FREQ] to [59.94Hz]. (→ 150)

[DF]/[NDF]

Selects the compensation mode for the time code. (→ 72)

[TCG]

[FREE RUN]/[REC RUN]

Sets the way the time code will move. (→ 72)

[TC PRESET]

Initial value of the time code can be set. (→ 73)

[UB PRESET]

- Set [REC MODE] to [AVCHD]. (→ 150)

User Information can be set. (→ 73)

[EXT TC LINK]

[MASTER]/[SLAVE]

You can synchronize the time code of the external device with that of this unit. (→ 74)

Audio Setup



All default settings are indicated with underlined text.

 : **[AUDIO SETUP]** → desired setting

[AUDIO LOW CUT CH1]

[ON]/[OFF]

Reduces the level of low-pitched sound for audio channel 1.

- You may not see the full effect depending on the recording conditions.

[AUDIO LOW CUT CH2]

[ON]/[OFF]

Reduces the level of low-pitched sound for audio channel 2.

- You may not see the full effect depending on the recording conditions.

[AUDIO ALC LINK]

- Set the CH1/CH2 switch to **MANU.** (→ 69)
- Set **[AUDIO ALC CH1]/[AUDIO ALC CH2]** to **[ON]**. (→ 70)

[ON]/[OFF]

If you set this item to **[ON]**, when ALC works for either of the audio channels, it will also work for the other audio channel. (→ 70)

[AUDIO ALC CH1]

[ON]/[OFF]

If you set this item to **[ON]**, you can reduce the audio noise of audio channel 1. It will record with natural sound when set to **[OFF]**. (→ 70)

[AUDIO ALC CH2]

[ON]/[OFF]

If you set this item to **[ON]**, you can reduce the audio noise of audio channel 2. It will record with natural sound when set to **[OFF]**. (→ 70)

[INPUT1 LINE LEVEL]

[+4dBu]/[0dBu]

Sets the input level of the audio equipment connected to AUDIO INPUT1 terminal (XLR 3 pin).

[INPUT2 LINE LEVEL]

[+4dBu]/[0dBu]

Sets the input level of the audio equipment connected to AUDIO INPUT2 terminal (XLR 3 pin).

[INPUT1 MIC LEVEL]

[-40 dB]/[-50 dB]/[-60 dB]

Sets the input level of the external microphone connected to AUDIO INPUT1 terminal (XLR 3 pin).

[INPUT2 MIC LEVEL]

[-40 dB]/[-50 dB]/[-60 dB]

Sets the input level of the external microphone connected to AUDIO INPUT2 terminal (XLR 3 pin).

Output Setup

Different menu items are displayed depending on whether this unit is in Recording Mode or Playback Mode.

All default settings are indicated with underlined text.

 : [OUTPUT SETUP] → desired setting

[OUTPUT SEL]



[HDMI]/[SDI]/[SDI+AV]

This changes the external output destination. (→ 116)

[RESOLUTION]



[SYSTEM]/[1080p]/[1080i]/[DOWN CONV.]

This changes the way in which images are output to an external device. (→ 116)

[SDI REMOTE]



[ON]/[OFF]

This enables/disables a function that controls recording performed with an external device connected to the SDI OUT terminal.

- When [HDMI TC OUTPUT] is set to [ON], you can also control an HDMI device. (→ 181)
- It is not possible to control recording performed with an external device connected to the SDI OUT terminal in the following cases:
 - When [REC FORMAT] is set to [SA 480/59.94i] or [SA 576/50.00i] (→ 151)
 - When [RESOLUTION] is set to [DOWN CONV.] (→ 116)

[REMOTE REC LINK]



When [ON] is selected, you can control recording performed with this unit and an external device using the recording start/stop button.

[ON]: Controls recording performed with this unit and an external device using the recording start/stop button.

[OFF]: Controls recording performed with an external device using the USER button function [AUTO REC]. (→ 90)

[SDI EDH]



When [ON] is selected, EDH is superimposed on images of SD signals (480i and 576i) output from the SDI OUT terminal.

- **(In Playback Mode)**
Touch the play mode select icon, and set this unit to Motion Picture Playback Mode. (→ 102)

[ON]/[OFF]

[SDI AUDIO GAIN CHG]



This adjusts the gain value of audio signals output from the SDI OUT terminal.

- Set [OUTPUT SEL] to [SDI] or [SDI+AV]. (→ 116)
- **(In Playback Mode)**
Touch the play mode select icon, and set this unit to Motion Picture Playback Mode. (→ 102)

[0 dB]/[-6 dB]/[-12 dB]

[DOWN CONV.]





This function allows you to select how to display images with a 16:9 aspect ratio on an external monitor with a 4:3 aspect ratio.

- Set [OUTPUT BITS] to [4:2:2(8bit)]. (→ 31)
- Set [RESOLUTION] to [DOWN CONV.]. (→ 116)

[SIDE CROP]:	Outputs images so that they are fit to the height of the external monitor screen.
[LETTERBOX]:	Outputs images so that they are fit to the width of the external monitor screen.
[SQUEEZE]:	Outputs horizontally-compressed images so that they are fit to the screen.

- This item is fixed to [SQUEEZE] in the following cases:
 - When [REC FORMAT] is set to a setting with a size of 4K (4096×2160) or UHD (3840×2160)
 - When [REC FORMAT] is set to [SA 480/59.94i] or [SA 576/50.00i]

■ Example of images with a [17:9] or [16:9] aspect ratio on an external monitor (4:3):

[RESOLUTION] setting	
[SYSTEM]/[1080p]/[1080i]	[DOWN CONV.]
	

* The screen is displayed this way when [RESOLUTION] is set to [DOWN CONV.] and [DOWN CONV.] is set to [LETTERBOX]. (→ 180)

- When [DOWN CONV.] is set to [SIDE CROP], the sides of an image will be cut off, causing some icons on the external monitor to be hidden from the external monitor screen.

[HDMI UHD OUTPUT LIMIT]



This sets a frame rate when outputting scenes in the recording format [UHD 2160/59.94p 150M] or [UHD 2160/50.00p 150M] from the HDMI OUT terminal.

(When [SYSTEM FREQ] is set to [59.94Hz])

[59.94p]:	Outputs scenes in 2160/59.94p.
[29.97p]:	Outputs scenes in 2160/29.97p

(When [SYSTEM FREQ] is set to [50.00Hz])

[50.00p]:	Outputs scenes in 2160/50.00p.
[25.00p]:	Outputs scenes in 2160/25.00p.

[HDMI TC OUTPUT]



Switches the output setting of time code information when this unit is connected to another device (HDMI-SDI converter, etc.) with an HDMI cable.

- **(In Playback Mode)**

Touch the play mode select icon, and set this unit to Motion Picture Playback Mode.

(→ 102)

[ON]/[OFF]

[VOLUME]



When [ON] is selected, you can adjust the headphone volume in Recording Mode with the jog dial.

(→ 101)

[ON]/[OFF]

[TEST TONE]



Selects the test tone output when color bars are displayed. (→ 96)

[OFF]:	Does not output a test tone.
[LEVEL 1]:	Outputs a high volume test tone.
[LEVEL 2]:	Outputs a low volume test tone.

[VIDEO SETUP]



This sets the setup level of 480i image signals.

- Set [SYSTEM FREQ] to [59.94Hz]. (→ 150, 188)

[0%]/[7.5%A]

- AG-DVX200PJ/PB: This function's default setting is [7.5%A].
AG-DVX200EJ/EN/ED/PX: This function's default setting is [0%].

[LCD/EVF OUTPUT]



[AUTO]/[LCD]/[EVF]

This sets how to turn on/off the LCD monitor and viewfinder. (→ 24)

Display setting

Different menu items are displayed depending on whether this unit is in Recording Mode or Playback Mode.



All default settings are indicated with underlined text.

 : [DISP SETUP] → desired setting

[ZEBRA DETECT 1]



Selects the brightness level of the left-leaning zebra patterns on the screen.

- 1 Touch [ZEBRA DETECT 1].**
 - Touch [YES].
- 2 Touch  /  to adjust settings.**
 - You can select a value between 50% and 105%.
- 3 Touch [EXIT] to complete the setting.**



- This function's default setting is "80%".

[ZEBRA DETECT 2]



[SET]/[OFF]

Selects the brightness level of the right-leaning zebra patterns on the screen.

- 1 Touch [ZEBRA DETECT 2].**
 - Touch [SET].
- 2 Touch  /  to adjust settings.**
 - You can select a value between 50% and 105%.
- 3 Touch [EXIT] to complete the setting.**
 - You can display [ZEBRA 2] after setting the level. (→ [88](#), [166](#))

- This function's default setting is "100%".

[MARKER]



[ON]/[OFF]

Displaying of the luminance level display marker can be switched.

- Marker can be displayed when set to [ON]. (→ [88](#), [166](#))

[GUIDE LINES]



[]/[]/[]/[OFF]

You can check if the image is level while recording motion pictures and still pictures. The function can also be used to estimate the balance of the composition.

- The guidelines do not appear on the images actually recorded.
-
- The setting changes as follows when using Focus Assist. (→ 48)
 - The guidelines are not displayed. (They are displayed on the external monitor when this unit is connected to the external monitor.)
 - The setting cannot be changed.

[SAFETY ZONE]



Display of the range that can be displayed with the external monitor (safety zone **A**) can be switched.

(When [16:9 90%] is set)

Aspect ratio	[SAFETY ZONE]
16:9	[16:9 90%]/[4:3]/[14:9]/[1.85:1]/[17:9]/ [2:1]/[2.35:1]/[2.39:1]/[OFF]
4:3*	[4:3 90%]/[4:3]/[OFF]



* When [REC FORMAT] is set to [SA 480/59.94i] or [SA 576/50.00i] and [ASPECT CONVERT] is set to [SIDE CROP] (→ 151, 158)

- The safety zone is not displayed on the images that is actually recorded.

[CENTER MARKER]



[ON]/[OFF]

Displays/hides the center marker.

[REC COUNTER]



[TOTAL]/[SCENE]

Selects the operation of the Recording Counter during recording. (→ 74)

[SHUTTER DISPLAY CHG]



Changes the setting for the shutter speed display.

[sec]: Displays shutter speeds as time.

[deg]: Displays shutter speeds as open angles of the shutter.

[GAIN/ISO DISPLAY CHG]



This changes the gain value unit in Recording Mode.

[GAIN]: Displays the gain value in dB.

[ISO]: Displays the gain value in ISO.

[ZOOM/FOCUS]



This changes the units of zoom and focus values.

[ZOOM/FOCUS] setting	Zoom value	Focus value
[NUMBER]	A value between 0 and 99 is displayed.	
[mm/feet]	Millimeter	Feet
[mm/m]	Millimeter	Meter
[OFF]	No value is displayed.	

[VIDEO OUT OSD]



- (In Recording Mode)
Set **[OUTPUT BITS]** to **[4:2:2(8bit)]**. (→ 31)

[ON]/[OFF]

The information displayed on the screen (operation icon and counter display etc.) can be displayed/not displayed on the external monitor. (→ 116)

[DATE/TIME]



[OFF]/[TIME]/[DATE]/[DATE&TIME]

It is possible to change the date and time display mode.

[DATE FORMAT]



[Y/M/D]/[M/D/Y]/[D/M/Y]

It is possible to change the date format.

- AG-DVX200P/PB: This function's default setting is [M/D/Y].
AG-DVX200EJ/EN/ED: This function's default setting is [D/M/Y].
AG-DVX200PX: This function's default setting is [Y/M/D].

[LEVEL GAUGE]



[ON]/[OFF]

This function displays the horizontal/vertical tilt of the unit with the electronic level. (→ 85)

[HISTOGRAM]



[ON]/[OFF]

A graph with brightness as horizontal axis and number of pixels at that brightness as vertical axis is displayed. It is possible to determine the exposure of the whole image by looking at the distribution in the graph. (→ 95)

[AUDIO LEVEL METER]



• (In Playback Mode)

Touch the play mode select icon, and set this unit to Motion Picture Playback Mode.

(→ 102)

[ON]/[OFF]

Select to display the audio level meter.

[LENS STATUS]



[ON]/[OFF]

Display relating to lens can be switched. (Zoom Display, Optical Image Stabilizer, ND filter, Focus Display, White Balance, Iris, Gain, Auto Iris, Shutter Speed)

[CARD & BATTERY]



[ON]/[OFF]

Display can be switched between the remaining recordable time of the SD card and the remaining battery capacity indication.

[OTHER DISPLAY]



[ON]/[OFF]

This shows or hides indications on the screen except for [USER BUTTON DISPLAY], [GUIDE LINES], [SAFETY ZONE], [CENTER MARKER], [DATE/TIME], [AUDIO LEVEL METER], [LENS STATUS] and [CARD & BATTERY].

[LCD BACKLIGHT]



[HIGH]/[LOW]

Switches the brightness on the LCD monitor. (→ 26)

[LCD SET]



[COLOR]/[BRIGHTNESS]/[CONTRAST]

It adjusts brightness and color density on the LCD monitor. (→ 26)

- The default settings are as follows:
 - [COLOR]: “0”
 - [BRIGHTNESS]: “0”
 - [CONTRAST]: “0”

[EVF SETTING]



[COLOR]/[BRIGHTNESS]/[CONTRAST]

Adjusts the brightness and color intensity of the viewfinder. (→ 27)

- The default settings are as follows:
 - [COLOR]: “0”
 - [BRIGHTNESS]: “0”
 - [CONTRAST]: “0”

[EYE SENSOR]



Adjusts the eye sensor sensitivity. (→ 28)

- This function's default setting is “-4”.

[SELF SHOOT]



[MIRROR]/[NORMAL]

Switches the mirror function of the LCD monitor when recording yourself. (→ 28)

The image on the LCD monitor is displayed mirrored horizontally during recording of yourself when it is set to [MIRROR].

[EVF COLOR]



[ON]/[OFF]

The recording images or playback images on the viewfinder can be selected between color/black and white. (→ 28)

[EVF/LCD DETAIL]



[ON]/[OFF]

Setting this item to [ON] helps you achieve focus easier by emphasizing the outlines of an image displayed on the LCD monitor and viewfinder. (→ 45)

[EVF/LCD PEAK LEVEL]



Adjusts the emphasis strength for [EVF/LCD DETAIL]. (→ 45)

- This function's default setting is "0".

[EVF/LCD PEAK FREQ.]



[HIGH]/[LOW]

Sets the peaking frequency for [EVF/LCD DETAIL]. (→ 45)

Other Functions

Different menu items are displayed depending on whether this unit is in Recording Mode or Playback Mode.

All default settings are indicated with underlined text.

 : [OTHER FUNCTION] → desired setting

[FORMAT MEDIA]



The SD card or the external media device can be formatted. (→ 32, 128)

- Please be aware that if a medium is formatted, then all the data recorded on the medium will be erased and cannot be restored. Back up important data on a PC etc. (→ 123)

[MEDIA STATUS]



- (In Recording Mode)
Set **[OUTPUT BITS]** to **[4:2:2(8bit)]**. (→ 31)

The used space and remaining recordable time of the SD card can be checked.

- Touching [CHANGE MEDIA] switches the unit between the display for the SD card 1 and the display for the SD card 2.
- Only in Recording Mode, remaining recordable time for the selected recording format is displayed.
- Touch [EXIT] to close the indication.

- The SD card requires some space to store information and manage system files, so the actual usable space is slightly less than the indicated value. The usable space is generally calculated as 1 GB=1,000,000,000 bytes. The capacities of this unit, PCs and software are expressed as 1 GB=1,024×1,024×1,024=1,073,741,824 bytes. Therefore, the indicated value of the capacity appears to be smaller.

[REC LAMP]



[FRONT]/[REAR]/[BOTH]/[OFF]

The recording lamp lights up during recording. When this is set to [OFF], it does not light during recording.

[CLOCK SET]



Set date and time. (→ 29)

[TIME ZONE]



Set the time difference from Greenwich Mean Time. (→ 29)

[ALERT SOUND]



[OFF]/ (Volume low)/ (Volume high)

Touch screen operation, start and stop of recording can be confirmed with this sound. When [OFF] is selected, the sound is not output at the start/end of recording, etc.

2 Beeps for 4 times

When an error occurs. Check the message displayed on the screen. (→ 197)

[ECONOMY (BATT)]



[ON]/[OFF]

When about 5 minutes have passed without any operation, this unit automatically turns off to save battery life.

- This unit will not automatically turn off even if the [ECONOMY (BATT)] is set to [ON] in following cases:
 - PRE-REC is used (→ 86, 174)
 - When [USB MODE SELECT] is set to [DEVICE] and this unit is connected to a PC. (→ 123)

[ECONOMY (AC)]



[ON]/[OFF]

When connected to AC adaptor about 15 minutes have passed without any operation, this unit automatically turns off.

- This unit will not automatically turn off even if the [ECONOMY (AC)] is set to [ON] in following cases:
 - PRE-REC is used (→ 86, 174)
 - When [USB MODE SELECT] is set to [DEVICE] and this unit is connected to a PC. (→ 123)

[SYSTEM FREQ]



Set the system frequency of this unit. (→ 150)

[USB MODE]



[ON]/[OFF]

Enable/disable connections to the USB terminals of this unit.

- If you switch from [ON] to [OFF] while a USB terminal is in use, a message may be displayed, asking you to unmount the USB cable safely. Select [YES] to terminate the connection safely.

[USB MODE SELECT]



The unit's USB terminal to which a USB Cable will be connected can be switched. Switch the terminal according to the shape of the USB Cable's plug you intend to connect to the unit.

[HOST]: For connecting to the USB HOST terminal (Type A) of the unit

[DEVICE]: For connecting to the USB DEVICE terminal (Type Micro-B) of the unit

[INITIAL SET]



The menu settings or [CUSTOMIZE SCENE] are reset to the default. (→ 139)

[ALL]: This is for initializing all menus.*

[SCENE]: This is for initializing the setting of customize scene.

[NETWORK]: This is for initializing the [NETWORK SETUP] menu settings.

[NO]: This is for not performing initialization.

* Settings for [CLOCK SET], [TIME ZONE] and [SYSTEM FREQ] will not be changed.

- Returning all settings to the default is not possible during Freeze Frame. (→ 81)

[NUMBER RESET]



Set the file number of the MOV/MP4 and still picture recorded next to 0001.

- Folder number is updated and file number will start from 0001. (→ 124)
- To reset the folder number, format the SD card, and then perform [NUMBER RESET].

[COLOR TONE]



You can change the color reproduction setting.

[NATURAL]: This setting reproduces colors more naturally. It allows you to easily set a color tone consistent with that of other models.

[Ver. 1.4]: This setting is compatible with the color reproduction capabilities provided by firmware versions earlier than Ver.1.50.

- When using customized color reproduction settings in [SCENE FILE], changing this setting changes the color tone. It is recommended that you check how colors are reproduced after changing this setting.

[LANGUAGE]



You can select the language on the screen display and the menu screen.

NETWORK SETUP



All default settings are indicated with underlined text.

MENU  : [NETWORK SETUP] → **desired setting**

[USER ACCOUNT]

[SET]/[OFF]

Set up a login user account for the AG ROP application. (→ 132)

[WIRELESS SETUP]

[DIRECT]/[SSID(SELECT)]/[SSID(MANUAL)]

Set the wireless LAN connection method. (→ 134)

[Wireless LAN setup]

[IP Address]/[Subnet Mask]/[Gateway][DHCP]/[MAC Address]

You can change or check the network setup, such as the IP address, subnet mask, and MAC address for wireless LAN connections. (→ 133)

[CONNECTION HISTORY]

A history of connections made to wireless access points are displayed. You can easily connect with the same settings as used previously by selecting a connection record from History. (→ 137)

[NETWORK INITIAL SETTING]

You can change the [NETWORK SETUP] menu back to the default condition.

[NETWORK SETUP PASSWORD]

[Setup]/[Delete]

This will set/clear the Password to limit the startup of the [NETWORK SETUP] menu. By setting the Password, it will prevent erroneous operation, prevent wrongful use of the wireless LAN function by third party, and protect the set personal information.

1 Touch [Setup].

2 Enter a password (six characters).

- After finish entering the Password, touch [Enter].
- For details on how to enter characters, refer to page 133.

3 Re-enter the password.

- After finish entering the Password, touch [Enter].
 - If the Passwords match with each other, a message is displayed.
-
- After setting a password, you will be required to enter it each time you touch the [NETWORK SETUP] menu.
 - If you have forgotten the password, from the menu, select [OTHER FUNCTION] → [INITIAL SET] → [NETWORK]. This will reset the [NETWORK SETUP] menu to the default settings, allowing you to use it again.

Maintenance



MENU  : [MAINTENANCE] → desired setting

[VERSION]

The version of the firmware of this unit is displayed.

[UPDATE]

The firmware of this unit is updated. (→ 208)

[HOUR METER]

This displays the operation time of this unit, how many times the zoom lever has been operated, and how many times the zoom motor has worked.

Video Setup



All default settings are indicated with underlined text.

- Press the **THUMBNAIL** button to switch this unit to the **Playback Mode**.
- Touch the play mode select icon, and set this unit to **Motion Picture Playback Mode**.
(→ 102)

: [VIDEO SETUP] → desired setting

[REPEAT PLAY]

[ON]/[OFF]

Playback of the first scene starts after playback of the last scene finishes when set to [ON]. (→ 108)

[RESUME PLAY]

[ON]/[OFF]

If playback of a scene was stopped halfway, the playback can be resumed from where it was stopped when set to [ON]. (→ 108)

[SCENE PROTECT]

Scenes can be protected so that they are not deleted by mistake.

(Even if you protect some scenes, formatting the SD card will delete them.) (→ 111)

[DELETE]

Deletes a scene. (→ 110)

Picture Setup



- Press the **THUMBNAIL** button to switch this unit to the **Playback Mode**.
- Touch the play mode select icon, and set this unit to **Still Picture Playback Mode**. (→ 102)

: [PICT. SETUP] → desired setting

[SCENE PROTECT]

Still pictures can be protected so that they are not deleted by mistake.

(Even if you protect some still pictures, formatting the SD card will delete them.) (→ 111)

[DELETE]

Deletes a still picture. (→ 110)

Copy



- Press the THUMBNAIL button to switch this unit to the Playback Mode.

MENU



: [COPY] → desired setting

[COPY ONCE]

This copies all scenes and still pictures recorded with this unit that have never been copied to another device to the external media device connected to this unit. (→ 128)

[SELECT COPY]

This allows you to select and copy the scenes/still pictures. You can copy between the SD cards in this unit or from either of them to the external media device. (→ 112, 129)

[1 → 2]/[2 → 1]/[1 →]/[2 →]

Indications

■ Recording indications

Example: Display in English

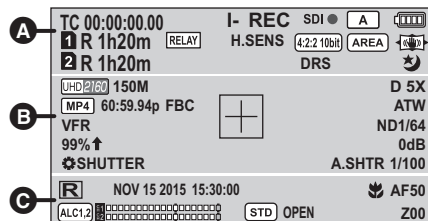

A	
TC 00:00:00.00/TC 00:00:00.00	
Counter display (→ 71)	
I-	Interval Recording (→ 173)
I-REC (Red)	Interval Recording (Recording)
P-	PRE-REC (→ 86, 174)
P-REC (Red)	PRE-REC (Recording)
REC (Red)	Recording
REC (Flashing red)	Recording pause
REC	Recording is not possible. (→ 31)
SDI ●, SDI II	Automatic recording (→ 90)
A	Auto Mode (→ 36)
	Remaining battery power (→ 19)
1, 2 (White)	Recording to card possible (motion picture)
1, 2 (Green)	Card is being recognized (motion picture)
R 1h20m	Remaining time for motion picture recording (→ 33)
RELAY	Relay recording (→ 170)
SIMUL	Simultaneous recording (→ 171)
BACKGR	Background recording (→ 171)
DUAL 50M, DUAL 8M	Dual codec recording (→ 171, 172)

H.SENS	High sensitivity recording mode (→ 158)
V-Log L	V-Log L Mode (→ 149)
4:2:2 10bit	Output bits (→ 31)
AREA	Area Mode (→ 82)
AF-AREA	AF area width adjustment (→ 47, 90)
Freeze	Freeze Frame (→ 81)
	Image Stabilizer (→ 42)
Assist	Log View Assist (→ 94)
DRS	DRS (→ 81, 148)
	Infrared recording (→ 84, 175)

B	
4K 2160, UHD 2160, FHD 1080, PS 1080, PH 1080, HA 1080, HE 1080, PM 720, SA	
Recording format (→ 151)	
4K 2160, UHD 2160, FHD 1080	
Output format (→ 157)	
ALL-I, 150M, 100M, 50M	
Bit rate (→ 151)	
D 2X, D 5X, D 10X	Digital Zoom (→ 93)
MOV, MP4	
Recording mode (→ 150)	

60:59.94p/50:50.00p	Frame rate in Variable Frame Rate Mode (→ 91, 140)
59.94p, 59.94i, 50.00p, 50.00i, 29.97p, 25.00p, 24.00p, 23.98p	Frame rate (→ 151)
FBC	Flash band compensation (→ 86, 149)
FastScan	FastScan (→ 151, 157)
ATW, LOCK, P3200K, P5600K, VAR, Ach, Bch	White Balance (→ 55)
VFR	Variable Frame Rate mode (→ 91, 140)
LT.BOX	When [ASPECT CONVERT] is set to [LETTERBOX] (→ 158)
ND 1/4, ND 1/16, ND 1/64	ND filter (→ 97)
99% ↑	Luminance level (→ 82, 88)
<input type="checkbox"/>	Luminance display frame (→ 88)
+	Center Marker (→ 183)
AGC, ISO AUTO, 0dB, ISO500	Gain value (→ 61)
SHUTTER	Multi Manual Function (→ 100)
A.SHTR	Auto Shutter display (→ 64)
1/100, 5.0d	Shutter speed (→ 64)
1/100.0	Synchro Scan (→ 66)
C	
R	Time Stamp recording in progress (→ 175)
2015 NOV 15 15:30:00	
NOV 15 2015 15:30:00	
15 NOV 2015 15:30:00	
NOV 15 2015 15:30:00	
15 11 2015 15:30:00	
2015 11 15 15:30:00	
Date indication	
Time indication (→ 29)	
S E	
Focus Transition bar (→ 53)	

	Focus Macro (→ 78, 165)
AF50, MF50, MA50, AF 00, MF 00, MA 00	Focus (→ 44)
ALC1	When [AUDIO ALC CH1] is enabled (→ 70)
ALC2	When [AUDIO ALC CH2] is enabled (→ 70)
ALC1,2	When [AUDIO ALC CH1], [AUDIO ALC CH2] are enabled (→ 70)
ALC1,2L	When [AUDIO ALC CH1], [AUDIO ALC CH2], [AUDIO ALC LINK] are enabled (→ 70)
ALC	When [AUDIO ALC CH1], [AUDIO ALC CH2], and [AUDIO ALC LINK] are enabled and audio cannot be recorded. (→ 91)
	Audio level meter (→ 69)
A.REC.	Sound recording disabled (→ 91)
STD	Auto iris mode (→ 59)
	Backlight Compensation (→ 78)
	Spotlight (→ 79)
OPEN, F2.0	Iris value (→ 59)
Z00	Zoom magnification (→ 40)
iZ99 1.00	i.Zoom magnification (→ 40)
Z99	Fast Zoom (→ 40)
1, 2 (White)	Card recording possible status (still picture)
8.8m, 8.3m, 2.1m, 0.9m, 0.3m, 0.2m	Number of recording pixels for still pictures (→ 34, 107)
In Playback Mode, the picture size is not displayed for still pictures recorded with other products that have different picture sizes from the sizes shown above.	
R3000	Remaining number of still pictures (→ 34)
(Red)	Recording still picture

■ Playback indications

Example: Display in English

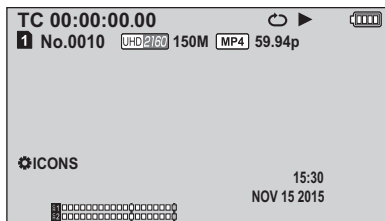

Display during playback (→ 102, 106)

TC 00:00:00.00/TC 00:00:00:00

Counter Display (→ 71)

15:30 Time indication (→ 29)

NOV 15 2015 Date indication (→ 29)

15 11 2015

2015 11 15

No.0010 Scene Number

Repeat Playback (→ 108)

Resume Playback (→ 108)

100-0001 Still picture folder/file name

Protected motion pictures/still pictures (→ 111)

MOV, MP4, AVCHD

Recording mode (When thumbnails are displayed) (→ 102)

4K, UHD, FHD, DU50, DU8, PH, PS, HA, HE, PM, SA

Recording format (When thumbnails are displayed) (→ 102, 151)

10 Scene Number (In 9-scene display in thumbnail mode) (→ 102)

■ Indication of connection to the external media device

Playback of the external media device (→ 130)

■ Indication of connection to other devices

Accessing the card (→ 124)

■ Indications for wireless LAN connection

Wireless LAN connection status (→ 134)

AG ROP application connection status (→ 134)

■ Confirmatory indications

-- (Time display) The built-in battery is low. (→ 29)

Warning for recording of yourself (→ 28)

SD card is not inserted.

SD card is write-protected.

SD card is non-compatible.

SD card is full.

Playback-only SD card

Messages

Major confirmation/error messages to be indicated on the screen in text.

During recording/playback

Display	Description	Behavior and cause
CHECK CARD.	The SD card is not supported by this unit.	<ul style="list-style-type: none"> ● Check the SD card.
THIS CARD CANNOT RECORD IN VIDEO MODE.	This is displayed when the SD card has a capacity of less than 4 GB.	<ul style="list-style-type: none"> ● Use an SD card with a capacity of 4 GB or more.
INCOMPATIBLE CARD. CHECK CARD SPEED.	This is displayed if the maximum writing speed of the SD card is not fast enough.	<ul style="list-style-type: none"> ● The operation will continue. ● Use an SD card with a maximum writing speed that is fast enough.
CANNOT BE USED DUE TO INCOMPATIBLE DATA.	The SD card cannot be used with this unit.	<ul style="list-style-type: none"> ● Insert a recordable SD card.
CANNOT RECORD - INCOMPATIBLE CONTROL DATA.	The content versions do not match. This is displayed when the SD card contains scenes recorded with another device, for example.	<ul style="list-style-type: none"> ● Match the device and content version.
ERROR OCCURRED. RECORDING IS STOPPED.	This is displayed when the SD card is removed during recording or data cannot be written to the SD card correctly.	<ul style="list-style-type: none"> ● Check the SD card.
CANNOT RECORD.THE NUMBER OF SCENES HAS EXCEEDED THE MAXIMUM LIMIT.	No additional scenes can be recorded to the SD card.	<ul style="list-style-type: none"> ● Delete unnecessary scenes, or use a new SD card.
CANNOT RECORD - DATE CAPACITY IS FULL. Cannot record - Playlist capacity is full.	This is displayed when you try to record in excess of the maximum number of scenes allowed for one SD card.	<ul style="list-style-type: none"> ● The operation will stop. ● Replace the SD card or delete unnecessary scenes.
INVALID	This is displayed when the operation is invalid.	<ul style="list-style-type: none"> ● Before performing the operation, wait until this unit is ready for it.

Display	Description	Behavior and cause
ERROR - UNABLE TO REPAIR DATA.	This is displayed when the management information cannot be recovered.	<ul style="list-style-type: none"> ● Check the SD card.
CANNOT USE SD CARD IN VIDEO MODE, CONTROL DATA ERROR.	This is displayed when the management information cannot be recovered.	<ul style="list-style-type: none"> ● The operation will stop. ● Use another SD card to perform recording.
CONTROL DATA ERROR HAS BEEN DETECTED. (SD CARD)	Defective management information has been found.	<ul style="list-style-type: none"> ● The management information will be automatically recovered after this message is displayed.
VFR ON, NO AUDIO RECORDING	Audio cannot be recorded if you change the frame rate when using Variable Frame Rate Mode.	<ul style="list-style-type: none"> ● To record audio, disable Variable Frame Rate Mode.
CANNOT REC	Recording cannot be performed with this unit when [OUTPUT BITS] is set to [4:2:2(10bit)].	<ul style="list-style-type: none"> ● To perform recording with this unit, set [OUTPUT BITS] to [4:2:2(8bit)].
CANNOT PLAY.	This is displayed when an error in the recording folder name or file name has occurred, for example.	<ul style="list-style-type: none"> ● Check the SD card.

During thumbnail and menu operation

Display	Description	Behavior and cause
NO DATA.	There are no scenes in the currently selected recording mode option and recording format option.	<ul style="list-style-type: none"> Select a recording mode option or recording format option containing recorded scenes.
CANNOT REC IN THIS MODE.	Recording cannot be performed with this unit when [OUTPUT BITS] is set to [4:2:2(10bit)].	<ul style="list-style-type: none"> To perform recording with this unit, set [OUTPUT BITS] to [4:2:2(8bit)].
CANNOT DELETE.	The content versions do not match. This is displayed when you try to delete scenes recorded with another device, for example.	<ul style="list-style-type: none"> Match the device and content version.
CARD ERROR. PLEASE REFORMAT.	This is displayed when the SD card cannot be formatted.	<ul style="list-style-type: none"> Check the SD card. Replace the SD card in the card slot at which the error has occurred.
UNABLE TO FORMAT.	Formatting is not possible due to, for example, a problem with the SD card.	<ul style="list-style-type: none"> Check the SD card.
Cannot delete data on card.	The SD card cannot be formatted.	<ul style="list-style-type: none"> Check the SD card.
CANNOT PROTECT.	The content versions do not match. This is displayed when you try to set protection for scenes recorded with another device, for example.	<ul style="list-style-type: none"> Match the device and content version.
CANNOT RESET NUMBER.	The SD card cannot be used with this unit.	<ul style="list-style-type: none"> Insert a recordable SD card.

During USB Device mode

Display	Description	Behavior and cause
DISCONNECT USB CABLE.	An error has occurred while accessing the SD card, or the OS is not supported.	<ul style="list-style-type: none"> • Check the SD card. • Check to see if the OS is supported.

During USB Host mode

Display	Description	Behavior and cause
CANNOT CHECK CONNECTED DEVICE. DISCONNECT THE USB CABLE FROM THIS UNIT.	This is displayed when the device is connected to this unit with a product such as a USB hub.	<ul style="list-style-type: none"> • Do not connect the devices with a product such as a USB hub. Connect to this unit directly.
FORMATTING FAILED.	The external media device cannot be formatted.	<ul style="list-style-type: none"> • Change the connected external media device.

During copying between SD cards or copying to an external media device

Display	Description	Behavior and cause
PLEASE CHECK THE EXTERNAL MEDIA.	Copying cannot be performed due to, for example, a problem with the copy destination media device.	<ul style="list-style-type: none"> • Check the copy destination media device.
THIS SCENE CANNOT BE COPIED. Cannot copy: contains recordings from other devices.	This is displayed when one or more of the scenes you are trying to copy cannot be played back on this unit.	<ul style="list-style-type: none"> • Copy scenes except for the ones that cannot be copied.
COPY FAILED. PLEASE CHECK THE CARD.	An error has occurred while accessing the SD card.	<ul style="list-style-type: none"> • Check the SD card.
Cancel card lock to write information.	The write-protect switch of the copy destination SD card is locked.	<ul style="list-style-type: none"> • Unlock the write-protect switch of the SD card.





During wireless LAN connection

Display	Description	Behavior and cause
Connection to wireless access point failed.	This is displayed when a connection to the wireless access point cannot be established.	<ul style="list-style-type: none"> • Check the settings for [WIRELESS SETUP] and [Wireless LAN setup], and the settings on the wireless access point.

Warning Indications

When an error is detected immediately after this unit is turned on or while it is being operated, the status indicator, on-screen displays and the AG ROP application screen (during AG ROP connection) inform you of the error.

System error	Status indicator	It flashes once per second.
	On-screen display	—
	AG ROP application screen	[WARNING] flashes four times per second.
	Meaning of the warning	A reference signal error or communication error has occurred.
	Recording/playback	The operation stops.
	Solution	Turn off and on this unit. If the warning persists, consult your dealer.
The battery is depleted (Low input voltage)	Status indicator	It flashes once per second.
	On-screen display	The message [LOW BATTERY.] is displayed.
	AG ROP application screen	[WARNING] lights up.
	Meaning of the warning	The battery is depleted.
	Recording/playback	The operation stops. This unit turns off automatically.
	Solution	Charge or replace the battery. Connect the AC adaptor to cancel the warning.
The card is full	Status indicator	—
	On-screen display	The remaining recordable time flashes red when it reaches [R 0h00m].
	AG ROP application screen	[WARNING] lights up until you perform some operation after the recording.
	Meaning of the warning	The SD card capacity is full.
	Recording/playback	The recording stops.
	Solution	Delete unnecessary scenes, or use a new SD card.

Recording error	Status indicator	It flashes once per second.
	On-screen display	—
	AG ROP application screen	[] flashes four times per second.
	Meaning of the warning	A recording error or recording circuit setting error has occurred.
	Recording/playback	The recording may either continue or stop.
	Solution	Turn off and on this unit. If the warning persists, consult your dealer.
Card error	Status indicator	—
	On-screen display	[] is displayed.
	AG ROP application screen	[] flashes four times per second.
	Meaning of the warning	An SD card error has occurred during recording or playback.
	Recording/playback	The operation stops.
	Solution	Replace the SD card.
The battery will be depleted soon	Status indicator	—
	On-screen display	The message [CHANGE THE BATTERY.] is displayed and  flashes red.
	AG ROP application screen	[] flashes once per second.
	Meaning of the warning	The battery will be depleted soon.
	Recording/playback	The operation continues.
	Solution	Charge or replace the battery as needed. Connect the AC adaptor to cancel the warning.

The card is nearly full	Status indicator	—
	On-screen display	The remaining recordable time flashes red. (When it is less than 1 minute)
	AG ROP application screen	[WARNING] flashes once per second. (When it is less than 1 minute)
	Meaning of the warning	The SD card is almost out of space.
	Recording/playback	The recording continues.
	Solution	Delete unnecessary scenes or use a new SD card as needed.
The cooling fan has stopped	Status indicator	It flashes twice per second.
	On-screen display	—
	AG ROP application screen	[WARNING] flashes four times per second.
	Meaning of the warning	A cooling fan error has stopped the cooling fan.
	Recording/playback	The operation stops and this unit turns off automatically.
	Solution	Check to see if the air inlet or outlet is blocked. If the warning persists, consult your dealer.

Troubleshooting

■ It is not a malfunction in following cases

The lens, the viewfinder or LCD monitor fog up.	<ul style="list-style-type: none"> This is due to condensation. This is not a malfunction. Please refer to page 2.
A clicking sound is heard when the unit is shaken.	<ul style="list-style-type: none"> This is the sound of the lens moving and is not a defect. This sound will no longer be heard when the unit is turned on and switch to Recording Mode.
Object seems to be warped.	<ul style="list-style-type: none"> Object seems to be warped slightly when the object moves across the image very fast, but this is because the unit is using MOS for the image sensor. This is not a malfunction.



Power

Problem	Check points
<p>This unit cannot be turned on.</p> <p>This unit does not stay on long enough.</p> <p>Battery runs down quickly.</p>	<ul style="list-style-type: none"> Charge the battery again to ensure it is sufficiently charged. (→ 16) In cold places, the battery using time becomes shorter. The battery has a limited life. If the operating time is still too short even after the battery is fully charged, the battery has worn out and needs to be replaced.
<p>This unit cannot be operated though it is turned on.</p> <p>This unit does not operate normally.</p>	<ul style="list-style-type: none"> Remove the battery or AC adaptor, wait about 1 minute and then reconnect the battery or AC adaptor. Then about 1 minute later, turn on the unit again. (Conducting the above operation while the SD card is being accessed may damage the data on the media.) If normal operation is still not restored, detach the power connected, and consult the dealer who you purchased this unit from.
<p>“ERROR OCCURRED. PLEASE TURN UNIT OFF, THEN TURN ON AGAIN.” is displayed.</p>	<ul style="list-style-type: none"> The unit has automatically detected an error. Restart the unit by turning off and on. The unit will be turned off in about 1 minute if the unit is not turned off and on. Repair is needed if it is repeatedly displayed even if it is restarted. Detach the power connected, and consult the dealer who you purchased this unit from. Do not attempt to repair the unit by yourself.

Indication	
Problem	Check points
Function display (Remaining Display, Counter Display, etc.) is not displayed.	<ul style="list-style-type: none"> ● [CARD & BATTERY] or [OTHER DISPLAY] of the [DISP SETUP] is [OFF]. (→ 185) ● Press the COUNTER button to switch the counter display. (→ 71)

Recording	
Problem	Check points
The unit arbitrarily stops recording.	<ul style="list-style-type: none"> ● Use an SD card that can be used for motion picture recording. (→ 21) ● The recordable time may have shortened due to the deterioration of the data writing speed or repeated recording and deletion. Using the unit, format the SD card. (→ 32)
Auto Focus function does not work.	<ul style="list-style-type: none"> ● If you are trying to record a scene which is hard to bring into focus in Auto Focus Mode, use the Manual Focus Mode to adjust the focus. (→ 37, 44)
Audio is not recorded.	<ul style="list-style-type: none"> ● Variable Frame Rate Mode or Interval Recording is enabled. (→ 91, 173) ● A REC is displayed and audio is not recorded in Variable Frame Rate Mode. ● Audio is not recorded for Interval Recording.
Color or brightness of the image changes, or you may see horizontal bars in the image. The LCD monitor flickers indoors.	<ul style="list-style-type: none"> ● Color or brightness of the image may change, or you may see horizontal bars in the image when the object is recorded under fluorescent light, mercury light or sodium light, etc., but this is not a malfunction. ● Record images in Auto Shutter Mode or adjust the shutter speed to 1/50, 1/60 or 1/100. ● Adjust the Synchro Scan shutter speed. (→ 66)

Playback

Problem	Check points
<p>Scenes/still pictures cannot be played back.</p>	<ul style="list-style-type: none"> ● Any scenes/still pictures where the thumbnails are displayed as  cannot be played back. ● In most cases,  is displayed for the following scenes: <ul style="list-style-type: none"> – Scenes recorded with another device or edited with editing software – Scenes with damaged data
<p>Scenes/still pictures cannot be deleted.</p>	<ul style="list-style-type: none"> ● Release the protect setting. (→ 111) ● Any scenes/still pictures where the thumbnails are displayed as  cannot be deleted. If the scenes/still pictures are unnecessary, format the SD card to erase the data. (→ 32) Please be aware that if a SD card is formatted then all the data recorded on the SD card is erased and cannot be recovered. Back up important data on a PC etc.

With other products

Problem	Check points
<p>Although this unit is correctly connected to an external monitor, images cannot be seen.</p> <p>The images are squeezed horizontally.</p>	<ul style="list-style-type: none"> ● Please read the operating instructions of your external monitor and select the channel that matches the input used for the connection. ● Change the setting of the unit depending on the cable connecting to the external monitor. (→ 116)
<p>Even when this unit is connected to the external monitor by the HDMI cable, images or sounds are not output.</p>	<ul style="list-style-type: none"> ● Check if the HDMI cable is connected correctly. ● Insert the HDMI cable all the way in.
<p>If the SD card is inserted in another device, it is not recognized.</p>	<ul style="list-style-type: none"> ● Check that the device is compatible with the capacity or type of SD card (SDHC Memory Card/SDXC Memory Card) that you inserted. Refer to the operating instructions of the device for details.
<p>When connected by the USB Cable, this unit is not detected by the other devices.</p>	<ul style="list-style-type: none"> ● When connected to other devices using only the battery, reconnect using the AC adaptor.

With a PC	
Problem	Check points
When connected by the USB Cable, this unit is not detected by the PC.	<ul style="list-style-type: none"> • After re-inserting the SD card into the unit, reconnect the USB Cable. • Select another USB terminal on the PC. • Check the operating environment. (→ 122) • Connect the USB Cable again after restarting the PC and turning on this unit again.
When the USB Cable is disconnected, an error message will appear on the PC.	<ul style="list-style-type: none"> • To disconnect the USB Cable safely, double-click the  icon in the task tray and follow the instructions on the screen.

Others	
Problem	Check points
If the SD card is inserted in this unit, it is not recognized.	<ul style="list-style-type: none"> • If the SD card is formatted on a PC, it may not be recognized by this unit. Use this unit to format SD cards. (→ 32)

■ If AVCHD scenes do not change smoothly when played back on another device

The images may be still for several seconds at the joins between the scenes if the following operations are performed when multiple scenes have been continuously played back using another device.

- Just how smoothly the scenes will be played back depends on the playback device. Depending on the device used, the images may stop moving and become still for a moment even when none of the following conditions are applicable.
- A continuous recording of motion picture data that exceeds 4 GB may momentarily stop at every 4 GB of data when played back with another device.

Principal reasons for not playing back smoothly
• The recording format [PS] was switched to another recording format when a scene was recorded
• When the scenes were recorded on different dates
• When scenes lasting under 3 seconds have been recorded
• When PRE-REC was used for recording
• When the Interval Recording is used
• When deleting scenes
• When scenes recorded more than 99 scenes on the same date

About recovery

If faulty management information is found, the messages may appear and a repair is performed. (Repairing may take time depending on the error.)

-  is displayed when abnormal management information is detected when the scenes are displayed in thumbnail.
-

- Use a sufficiently charged battery or the AC adaptor.
- Depending on the condition of the data, it may not be possible to completely repair the data.
- If recovery fails, it will not be possible to play back scenes recorded before the unit turned off.
- When data recorded on another device is recovered, it may not be possible to play back the data on this unit or the other device.
- If recovery fails, turn the unit off and on again after waiting awhile. If recovery fails repeatedly, format a media on the unit. Please be aware that if a media is formatted, then all the data recorded on the media will be erased.
- If the thumbnail information is recovered, displaying the thumbnails may become slower.

Others

Updating the firmware incorporated into the unit

Check the version of the camera in the main menu → [MAINTENANCE] → [VERSION], access the latest information on the firmware from the website described below, and then download the firmware as needed.

- Update completes by loading the downloaded files to the camera via the SD card. For details on update, visit the support desk at the following website:
<https://pro-av.panasonic.net>

Cautions for use

About this unit

The unit and the SD card become warm during use. This is not a malfunction.

Keep this unit as far away as possible from electromagnetic equipment (such as microwave ovens, TVs, video games etc.).

- If you use this unit on top of or near a TV, the pictures and/or sound on this unit may be disrupted by electromagnetic wave radiation.
- Do not use this unit near cell phones because doing so may result in noise adversely affecting the pictures and/or sound.
- Recorded data may be damaged, or pictures may be distorted, by strong magnetic fields created by speakers or large motors.
- Electromagnetic wave radiation generated by microprocessors may adversely affect this unit, disturbing the pictures and/or sound.
- If this unit is adversely affected by electromagnetic equipment and stops functioning properly, turn this unit off and remove the battery or disconnect AC adaptor. Then reinsert the battery or reconnect AC adaptor and turn this unit on.

Do not use this unit near radio transmitters or high-voltage lines.

- If you record near radio transmitters or high-voltage lines, the recorded pictures and/or sound may be adversely affected.

Make sure to use the supplied cords and cables. If you use optional accessories, use the cords and the cables supplied with them.

Do not extend the cords and the cables.

Do not spray insecticides or volatile chemicals onto the unit.

- If the unit is sprayed with such chemicals, its body may be marred and the surface finish may peel off.
- Do not leave rubber or plastic products in contact with the unit for a long time.

When you use the unit in a sandy or dusty place such as a beach, do not let sand or fine dust get into the body and terminals of the unit.

Also, keep the unit away from sea water.

- Sand or dust may damage the unit. (Care should be taken when inserting and removing a card.)
- If sea water splashes onto the unit, wipe off the water with a well wrung cloth. Then wipe the unit again with a dry cloth.

When carrying the unit, do not drop or bump it.

- A strong impact can break the unit's casing, causing it to malfunction.
- When carrying this unit, please hold the hand strap or shoulder strap firmly and treat it with care.

Cleaning

- Before cleaning, detach the battery or pull the AC cable from the AC outlet, and then wipe the unit with a soft, dry cloth.
- If the unit is very dirty, dip a cloth in water and squeeze firmly, and then wipe the unit with the damp cloth. Next, dry the unit with a dry cloth.
- Use of benzine, paint thinner, alcohol, or dishwashing liquid may alter the camera body or peel the surface finish. Do not use these solvents.
- When using a chemical dust cloth, follow the instructions that came with the cloth.

When you are not going to use the unit for an extended time

- When storing the unit, it is recommended that you place a desiccant (silica gel) in with it.

Do not lift up this unit by the handle with the tripod still attached

- When the tripod is attached, its weight will also affect the unit's handle, possibly causing the handle to break and hurting the user.
- To carry the unit while the tripod is attached, take hold of the tripod.

Do not swing the unit around, shake it by, or allow it hang from the handle

- Do not jar, swing, or shake the unit by its handle. Any strong jolt to the handle may damage the unit or result in personal injury.

Do not allow the cord to drag on the ground or pull a connected cord along the passage

- The cord will be damaged, causing fire or electrical shock, when the cord gets caught by the feet, excite will also cause personal injury.

When this unit is turned on, do not use it in direct contact with the skin for a long period of time.

- When using this unit for a long period of time, use a support such as a tripod. Low temperature burns may result if any high temperature part of this unit or hot air from the ventilation openings on the front side of the hand strap of this unit is in direct contact with the skin for a long period of time.

About the battery

The battery used in this unit is a rechargeable lithium-ion battery. It is susceptible to humidity and temperature and the effect increases the more the temperature rises or falls. In cold areas, the full charge indication may not appear or the low battery indication may appear about 5 minutes after starting use. At high temperatures, the protection function may be triggered, making it impossible to use the unit.

Be sure to detach the battery after use.

- If the battery is left attached, a minute amount of current continues to flow even if the unit is off. Keeping the unit in this state may result in over discharge of the battery. This may result in you not being able to use the battery even after it is charged.

- The battery should be stored in the vinyl bag so metal does not come into contact with the terminals.
- The battery should be stored in a cool place free from humidity, with as constant temperature as possible. (Recommended temperature: 15 °C to 25 °C (59 °F to 77 °F), Recommended humidity: 40%RH to 60%RH)
- Extremely high temperatures or low temperatures will shorten the life of the battery.
- If the battery is kept in high-temperature, high-humidity, or oily-smoky places, the terminals may rust and cause malfunctions.
- To store the battery for a long period of time, we recommend you charge it once every year and store it again after you have completely used up the charged capacity.
- Dust and other matter attached to the battery terminals should be removed.

Prepare spare batteries when going out for recording.

- Prepare batteries enough to last for 3 to 4 times the period you are planning to record for. Cold places such as a ski resort can shorten recording time.

If you drop the battery accidentally, check to see if the terminals are damaged.

- When this unit or battery charger is attached with the terminal part in a deformed state, this unit or battery charger may be damaged.

Do not throw old battery into fire.

- Heating a battery or throwing it into a fire may result in an explosion.

If the operating time is very short even after the battery has been recharged, the battery has worn out. Please purchase a new battery.

About the AC adaptor/battery charger

- If the temperature of the battery is extremely high or extremely low, charging may take time or the battery may not be charged.
- If the charging lamp keeps flashing, make sure that the terminals of the battery or the battery charger are not exposed to dirt, foreign objects or dust, then reconnect them properly.
Disconnect the AC cable from the AC outlet when you remove dirt, foreign objects or dust on the terminals of the battery or the battery charger.
If the charging lamp is still flashing, the temperature of the battery may be extremely high or extremely low or something may be wrong with the battery or battery charger. Contact your dealer.
- If you use the AC adaptor or battery charger near a radio, radio reception may be disturbed. Keep the AC adaptor or battery charger 1 m (3.3 feet) or more away from the radio.
- When using the AC adaptor or battery charger, it may generate whirring sounds. However, this is normal.
- After use, be sure to disconnect the AC cable from the AC outlet. (If you leave this unit connected, the AC adaptor will consume approximately 0.3 W and the battery charger approximately 0.3 W of current.)
- Always keep the electrodes of the AC adaptor, battery charger and battery clean.
- **Install the device near an AC outlet so that the power disconnection device (AC mains plug) can be accessed easily by hand.**

About the SD card

When disposing of or giving away the SD card, note that:

- Formatting and deletion of this unit or computer only changes the file management information and does not completely delete the data in the SD card.
- It is recommended that the main SD card is either physically destroyed or the SD card is physically formatted using this unit when disposing of or giving away the SD card.
- To physically format, connect this unit to the AC adaptor, select [OTHER FUNCTION] → [FORMAT MEDIA] → [SD CARD 1] or [SD CARD 2] from the menu, and touch [YES]. Press and hold recording start/stop button in the following screen for three seconds. Screen to delete the SD card data is displayed, so select [YES] and follow the instruction on the screen.

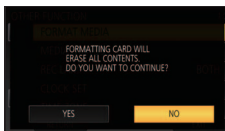

- The customer is responsible for the management of the data in the SD card.

LCD monitor/viewfinder

- When the LCD screen is dirty or condensation has occurred, please wipe it using a soft cloth such as a lens cloth.
- Do not touch the LCD monitor with your finger nails, or rub or press with strong force.
- It may become hard to see or hard to recognize the touch when the LCD protection sheet is affixed.
- When the unit has become very cold, for example due to storage in a cold area, its LCD monitor will be slightly darker than usual immediately after the unit is turned on. The normal brightness will be restored when the unit's internal temperature rises.

Extremely high precision technology is employed to produce the LCD Monitor screen. The result is more than 99.99% effective dots with a mere 0.01% of the dots inactive or always lit. However, this is not a malfunction and does not affect the recorded picture.

Extremely high precision technology is employed to produce the viewfinder screen. The result is more than 99.99% effective dots with a mere 0.01% of the dots inactive or always lit. However, this is not a malfunction and does not affect the recorded picture.

About copyright

■ Carefully observe copyright laws

IMPORTANT

“Unauthorized recording of copyrighted television programs, video tapes and other materials may infringe the right of copyright owners and be contrary to copyright laws.”

■ Licenses

- SDXC Logo is a trademark of SD-3C, LLC.
- “AVCHD”, “AVCHD Progressive” and the “AVCHD Progressive” logo are trademarks of Panasonic Corporation and Sony Corporation.
- Manufactured under license from Dolby Laboratories. Dolby and the double-D symbol are trademarks of Dolby Laboratories.
- HDMI, the HDMI Logo, and High-Definition Multimedia Interface are trademarks or registered trademarks of HDMI Licensing LLC in the United States and other countries.
- LEICA is a registered trademark of Leica Microsystems IR GmbH.
- DICOMAR is a registered trademark of Leica Camera AG.
- Microsoft® and Windows® are either registered trademarks or trademarks of Microsoft Corporation in the United States and/or other countries.
- Microsoft product screen shot(s) reprinted with permission from Microsoft Corporation.
- Intel®, Pentium®, Celeron® and Intel®Core™ are trademarks of Intel Corporation in the U.S. and/or other countries.
- Mac and OS X are trademarks of Apple Inc. registered in the U.S. and other countries.
- iPad is a trademark of Apple Inc., registered in the U.S. and other countries.
- App Store is a service mark of Apple Inc.
- “Wi-Fi®” is a registered trademark of Wi-Fi Alliance®.
- “WPA™”, and “WPA2™” are trademarks of Wi-Fi Alliance®.

- Other names of systems and products mentioned in these instructions are usually the registered trademarks or trademarks of the manufacturers who developed the system or product concerned.

This product is licensed under the AVC Patent Portfolio License for the personal use of a consumer or other uses in which it does not receive remuneration to (i) encode video in compliance with the AVC Standard (“AVC Video”) and/or (ii) decode AVC Video that was encoded by a consumer engaged in a personal activity and/or was obtained from a video provider licensed to provide AVC Video. No license is granted or shall be implied for any other use. Additional information may be obtained from MPEG LA, L.L.C.

See <http://www.mpegla.com>

- Separate license contracts must be obtained from MPEG LA where SD Memory Cards containing information recorded with this product are to be distributed to end users for commercial purposes. “End user” refers to persons or organizations handling such contents for personal use.

This item incorporates copy protection technology that is protected by U.S. patents and other intellectual property rights of Rovi Corporation. Reverse engineering and disassembly are prohibited.

Recording functions that cannot be used simultaneously

Due to the specifications of this unit, depending on the recording function being used, it is not possible to use or select certain other recording functions.

- “○”: Available; “—”: Not available*

* “Not available” includes instances where the desired function cannot be used or selected.

Recording function to be set	Currently set recording function					
	Interval Rec	VFR Mode	Relay recording	Simultaneous recording	Background recording	Dual codec recording
Interval Rec (→ 173)		—	○	○	○	○
VFR Mode (→ 91, 140)	○		○	○	○	○
Relay recording (→ 170)	—	—		○	○	○
Simultaneous recording (→ 171)	○	○	○		○	○
Background recording (→ 171)	—	—	○	○		○
Dual codec recording (→ 171, 172)	—	—	○	○	○	
PRE-REC (→ 86, 174)	—	—	○	○	—	○
Capture (→ 83)	—	—	○	○	○	○
Black Fade (→ 79)	—	—	○	○	○	○
White Fade (→ 79)	—	—	○	○	○	○
Time Stamp (→ 175)	○	—	○	○	○	—
Recording Check (→ 80)	—	○	○	—	—	○
Last Scene Delete (→ 80)	—	○	○	—	—	—

Recording modes/approximate recordable time

- SD cards are only mentioned with their main memory size. The stated times are the approximate recordable times for continuous recording.
- “h” is an abbreviation for hour, “min” for minute and “s” for second.
- If recording for long periods, prepare batteries for 3 or 4 times the period you wish to record for. (→ 18)
- When the default setting for [SYSTEM FREQ] is [59.94Hz]:
The default setting for [REC MODE] is [MP4], and the default setting for [REC FORMAT] is [UHD 2160/59.94p 150M].
When the default setting for [SYSTEM FREQ] is [50.00Hz]:
The default setting for [REC MODE] is [MP4], and the default setting for [REC FORMAT] is [UHD 2160/50.00p 150M].
- Maximum continuously recordable time for one scene: 10 hours
- The recording is paused once when the recording time for one scene exceeds 10 hours, and the recording will automatically resume after a few seconds.
- For information on the maximum continuous recordable time for one scene in Variable Frame Rate Mode, refer to page 93.
- The recordable time may be reduced if recording with a lot of action is recorded or recording of short scene is repeated.
- The recordable times depends on the recording condition or card type to be recorded.
- For information on picture sizes, frame rates, and bit rates in [REC FORMAT], refer to page 151.
- **When [REC MODE] is set to [MOV] or [MP4]**

Recording format	System frequency setting (→ 150)	SD card		
		4 GB	16 GB	64 GB
[4K 2160/24.00p 100M]	[59.94Hz]/ [50.00Hz]	—	20 min	1 h 20 min
[4K 2160/24.00p <small>FastScan 100M</small>]		—	20 min	1 h 20 min
[UHD 2160/59.94p 150M]	[59.94Hz]	—	—	55 min
[UHD 2160/29.97p 100M]		—	20 min	1 h 20 min
[UHD 2160/29.97p <small>FastScan 100M</small>]				
[UHD 2160/23.98p 100M]				
[UHD 2160/23.98p <small>FastScan 100M</small>]				
[FHD 1080/59.94p <small>ALL-I 200M</small>]		—	10 min	40 min
[FHD 1080/59.94p 100M]		—	20 min	1 h 20 min
[FHD 1080/59.94p 50M]		10 min	40 min	2 h 40 min
[FHD 1080/29.97p <small>ALL-I 200M</small>]		—	10 min	40 min
[FHD 1080/23.98p <small>ALL-I 200M</small>]				
[FHD 1080/29.97p 50M]				
[FHD 1080/23.98p 50M]				
[FHD 1080/59.94i 50M]		10 min	40 min	2 h 40 min

Recording format	System frequency setting (→ 150)	SD card		
		4 GB	16 GB	64 GB
[UHD 2160/50.00p 150M]	[50.00Hz]	—	—	55 min
[UHD 2160/25.00p 100M]		—	20 min	1 h 20 min
[UHD 2160/25.00p <small>FastScan 100M</small>]		—	10 min	40 min
[FHD 1080/50.00p <small>ALL-I 200M</small>]		—	20 min	1 h 20 min
[FHD 1080/50.00p 50M]		10 min	40 min	2 h 40 min
[FHD 1080/25.00p <small>ALL-I 200M</small>]		—	10 min	40 min
[FHD 1080/25.00p 50M]		10 min	40 min	2 h 40 min
[FHD 1080/50.00i 50M]		10 min	40 min	2 h 40 min

• When [REC MODE] is set to [AVCHD]

Recording format	System frequency setting (→ 150)	SD card		
		4 GB	16 GB	64 GB
[PS 1080/59.94p]	[59.94Hz]	19 min	1 h 20 min	5 h 20 min
[PH 1080/59.94i]		21 min	1 h 30 min	6 h
[PH 1080/23.98p]		30 min	2 h	8 h 30 min
[HA 1080/59.94i]		1 h 30 min	6 h 40 min	27 h 30 min
[PM 720/59.94p]		1 h	4 h 15 min	17 h 10 min
[SA 480/59.94i]		1 h	4 h	16 h 30 min
[PS 1080/50.00p]		[50.00Hz]	19 min	1 h 20 min
[PH 1080/50.00i]	21 min		1 h 30 min	6 h
[HA 1080/50.00i]	30 min		2 h	8 h 30 min
[HE 1080/50.00i]	1 h 30 min		6 h 40 min	27 h 30 min
[PM 720/50.00p]	1 h		4 h 15 min	17 h 10 min
[SA 576/50.00i]	1 h		4 h	16 h 30 min

Approximate number of recordable pictures

- SD cards are only mentioned with their main memory size. The stated number is the approximate number of recordable pictures.

Picture size	Aspect ratio	Memory Card		
		4 GB	16 GB	64 GB
8.8M 4096×2160	17:9	700	2900	11500
8.3M 3840×2160	16:9	750	3000	12000
2.1M 1920×1080		3200	12500	52000
0.9M 1280×720		7000	29000	118000
0.2M 640×360		28000	117000	475000
0.3M 640×480	4:3			

- Maximum number of recordable pictures that can be displayed is 9999. If the number of recordable pictures exceeds 9999, R 9999+ is displayed. The number will not change when the picture is taken until the number of recordable pictures is 9999 or less.
- The number of recordable pictures depends on the recording condition or card type to be recorded.
- The memory capacity indicated on the label of an SD card is the total of the capacity for copyright protection and management and the capacity which can be used on the unit, a PC etc.

