

Multi Format Compact Switcher

Operating Instructions (Volume II Advanced Settings)

Before operating the unit, please read this manual thoroughly and retain it for future reference.

MCS-8M

Software Version 1.03 or later

HDMI

Table of Contents (this manual)

Chapter 1 Overview

Introduction.....	II-5
System Configuration Examples	II-5

Chapter 2 Video Switching

Overview	II-7
Setting the Transition Type	II-8
General Transition Settings ([Misc] menu).....	II-8
AUX Mixing.....	II-9
Setting Wipes.....	II-10
Basic Operations for Wipe	II-10
Selecting the Pattern and Direction for Wipes	II-10
Making Detailed Adjustments to Wipe Patterns	II-10
Adding the Edge to the Wipe Pattern	II-12
Setting DME Wipes.....	II-12
Basic Operations for DME Wipe	II-12
Selecting the Pattern and Direction for DME Wipes	II-12
Making Detailed Adjustments to DME Wipe Patterns	II-13
Adding an Edge to a DME Wipe Pattern	II-14
Adjusting the Background Color of a DME Wipe	II-14
Details on [Effect] Menu	II-15
[Effect] Menu	II-15
[Wipe Modify] Menu	II-16
[DME Wipe Modify] Menu.....	II-18
Setting Keys.....	II-19
Basic Operations for Keys.....	II-19
Setting Key Transitions	II-20
Selecting the Pattern and Direction for Key Wipes.....	II-20
Making Detailed Adjustments to Key Wipe Patterns.....	II-20
Setting Key DME Wipes	II-20
Making Detailed Adjustments to Key DME Wipe Patterns.....	II-21
Selecting Key Types.....	II-21
Making Detailed Adjustments to the Luminance Key	II-21
Making Detailed Adjustments to the Linear Key	II-21
Making Detailed Adjustments to the Chroma Key	II-21
Setting the Key Fill and Key Source	II-21
Setting a Mask for a Key	II-22
Adding an Edge to a Key.....	II-22
Adjusting the Size and Position of the Key.....	II-22
Details on [Key] Menu	II-23
[Key] Menu	II-23
[Resizer] Menu	II-26
[Auto Chromakey] Menu	II-27
[Manual Chromakey] Menu	II-28
[Key Wipe Modify] Menu.....	II-29
[Key DME Wipe Modify] Menu	II-30

Chapter 3 Audio Mixing

Overview	II-31
Details on [Audio Channel] Menu	II-31

Chapter 4 Input Image Freezing and Frame Memory

Overview	II-34
Freezing Input Images.....	II-34
Selecting Frame Memory for Use as Frame Memory Video (FM).....	II-35
Saving Images to Frame Memory	II-35
Importing and Exporting Images.....	II-36
Importing Images.....	II-36
Export Frame Memory	II-36

Chapter 5 Importing and Exporting Files

Importing and Exporting Configuration Data	II-38
Exporting Configuration Data	II-38
Importing Configuration Data	II-39
Importing and Exporting Snapshots.....	II-39
Exporting Snapshots.....	II-39
Importing Snapshots.....	II-40
Formatting a USB Flash Drive	II-40

Chapter 6 3D System

Overview	II-41
Making the Necessary Settings.....	II-42
Setting the Signal Format and Video Size.....	II-42
Turning 3D Mode On	II-42
Confirming 3D Video Output.....	II-43

Chapter 7 Controlling External Devices

Enabling/Disabling Operation from External Devices	II-44
Connecting with External Devices.....	II-44
Setting GPI Inputs	II-44
Setting GPI Outputs/Tallies.....	II-44
Details on [GPI/Tally] Menu	II-45

Chapter 8 Setup ([Setup] Menu)

Overview	II-48
System Setup (System)	II-48
Details on [System] Menu	II-49
Audio Setup (Audio)	II-50
Details on [Audio] Menu	II-50
Video Input Setup (Video (Input))	II-52
Details on [Video (Input)] Menu	II-52
Assigning Video Input Signals to the Cross Point	
Buttons (Video (XPT))	II-53
Using the Shift Button Function.....	II-53
Details on [Video (XPT)] Menu	II-53
Video Output Setup (Video (Output))	II-54
Details on [Video (Output)] Menu	II-54
Setup of Other Video Related Items	
(Video (Misc))	II-55
Details on [Video (Misc)] Menu	II-55
Displaying Various Information (Information)	II-55
Installing Application Software and Firmware	
(Install)	II-55

Appendix

Message List	II-56
Errors	II-56
Warnings.....	II-57
Information.....	II-58
Index	II-59

Table of Contents (Volume I Basic Operation)

Chapter 1 Overview

Introduction
Names and Functions of Parts

Chapter 2 Preparations

Connecting Devices
Configuring System Settings
Configuring Video Signal Settings
Configuring Audio Signal Settings
Configuring Multi Viewer Settings

Chapter 3 Basic Operations

Switching Video
Composing Images with Keys
Composing Images Using
Picture-in-Picture (PinP)
Mixing Audio
Snapshots
Saving and Selecting Settings

Appendix

Effect Pattern List
Troubleshooting
Maintenance
Specifications
Index

About This Manual

This manual describes how to make adjustments and settings to enable you to use the advanced features of this unit.

For the basic operating procedures of the unit, see to “Operating Instructions (Volume I Basic Operation).”

How to View This Manual

About setting values

The setting values shown in bold are the factory default settings.

Examples:

Knob	Parameter	Meaning	Setting range
V3	Format	Signal format	108059 , 108050, 720p59, 720p50, 480i59, 576i50, Test1, Test2, Test3
V4	Aspect	Aspect ratio	16:9 , 4:3

About references

References to the Operating Instructions (Volume I Basic Operation) are indicated by the → mark as follows.

Example 1:

Channel faders (→ *Basic Operation: “Names and Functions of Parts”*)

Example 2:

For details, see “Effect Pattern List” (→ Basic Operation).

To find information on a specific topic

See “*Index*” (page II-59) at the end of this manual.

The index indicates whether the information can be found in “Volume I Basic Operation” or “Volume II Advanced Settings” and the corresponding page numbers.

Introduction

The unit allows you to adjust and set video effects, transitions, and audio in detail to perform more sophisticated switching. You can also perform 3D video switching, and use the frame memory function to write one screen of the input video to memory so that you can use it as input material.

System Configuration Examples

Example 1: When SD system

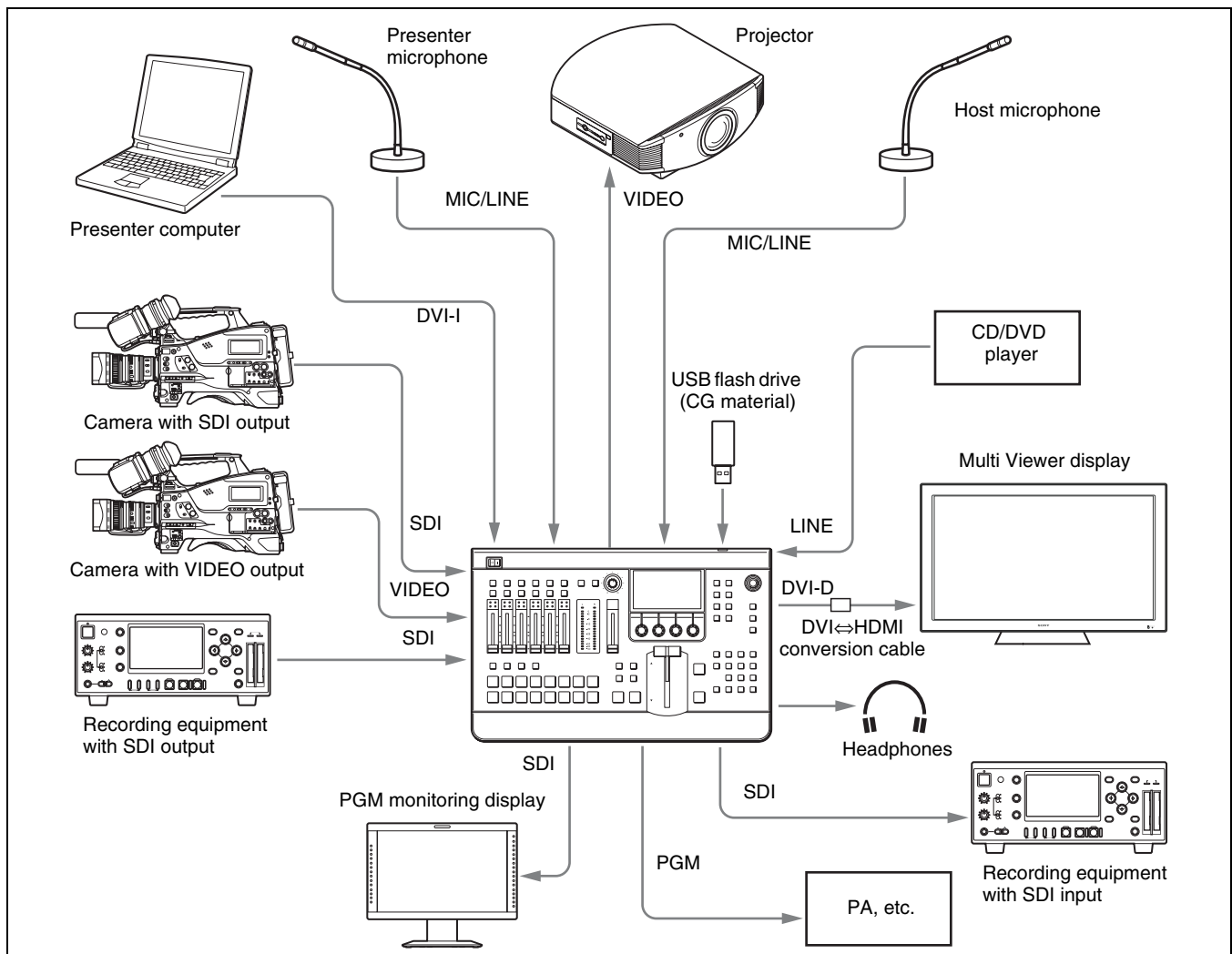

Example 2: When 3D system

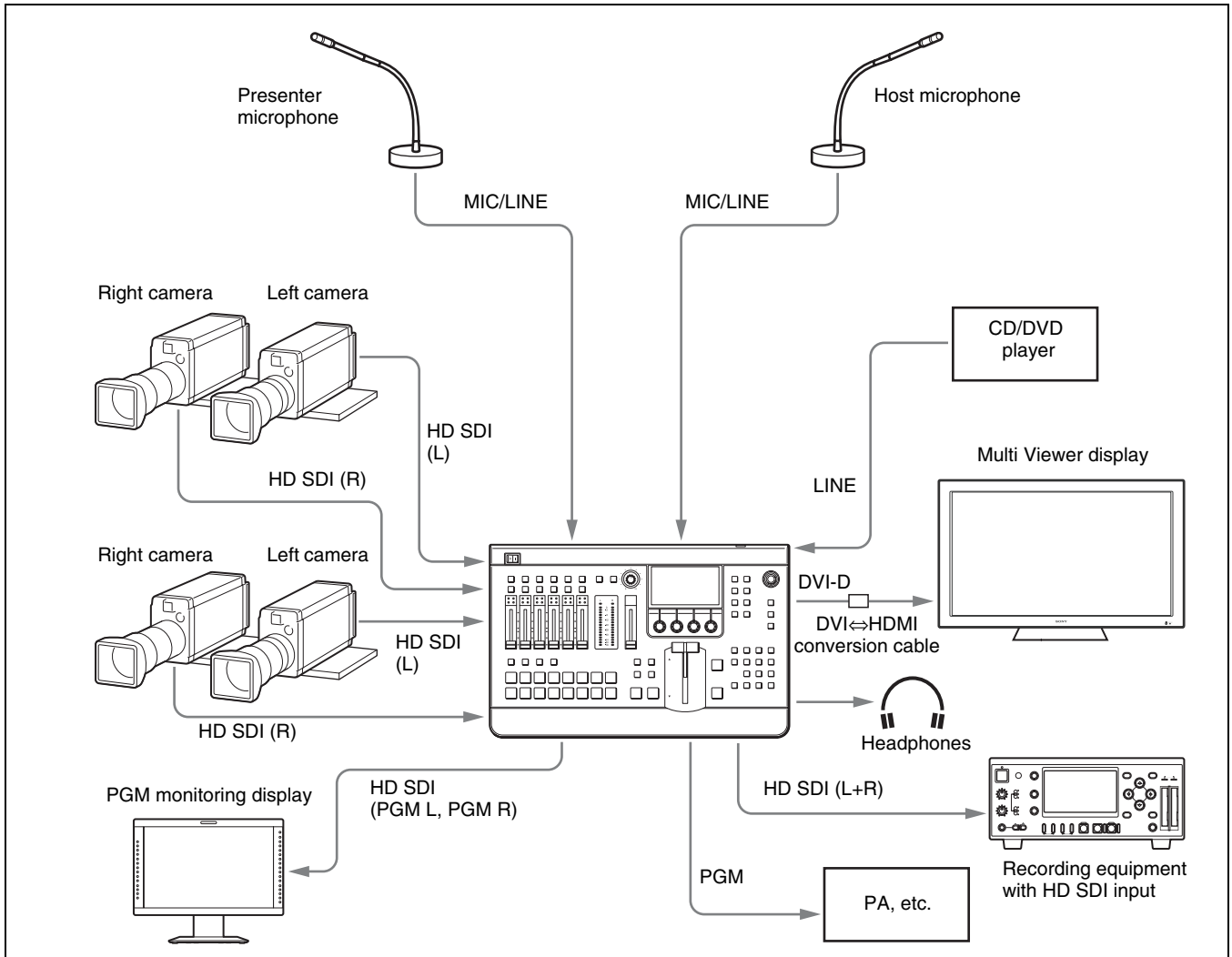

For details on configurations for 3D systems, see "Chapter 6: 3D System" (page II-41).

Overview

This unit includes three video composition blocks: M/E (Mix/Effect), Aux1, and Aux2. You can also apply transitions between the buses of each block.

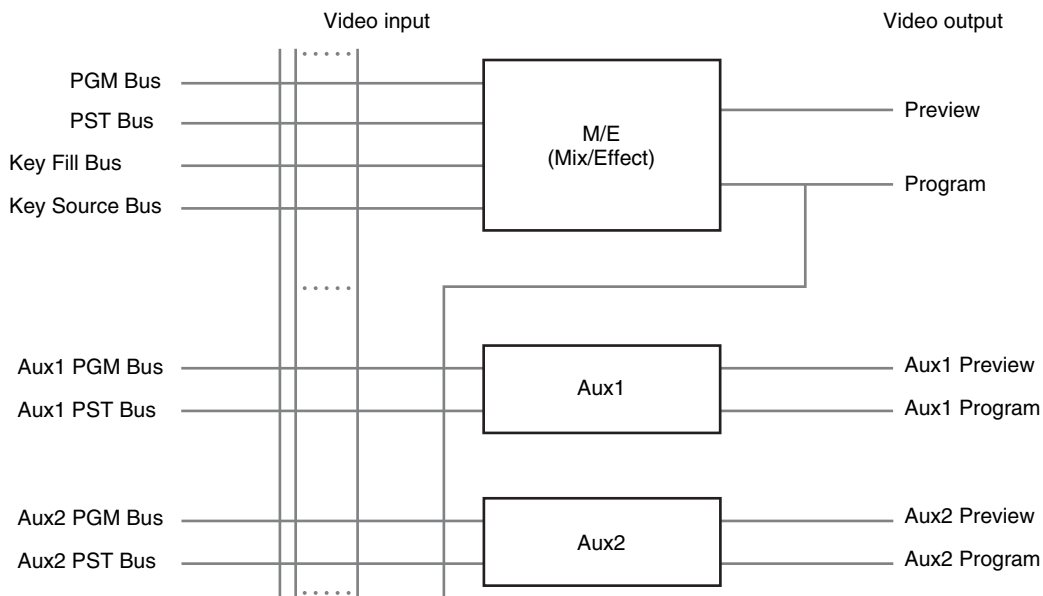

In the M/E block, you can add a variety of video effects while switching the video, as well as use keys to compose video. Although you cannot add wipe and key effects in the Aux blocks, video can be switched via mixing in these blocks. (See “AUX Mixing” (page II-9))

Transition, effect, and key adjustments and settings are performed in the following menus.

Menu	Description	Reference page
Misc	Set general transition settings (e.g., transition rates, color backgrounds).	II-8
Effect	Set the transition type.	II-8
	Set the wipe.	II-10
	Set the DME wipe.	II-12
Key	Set the key.	II-19

Setting the Transition Type

You can specify the transition type that is used when you perform effect transitions.

You can select any of the following transition types.

Wipe: Use a wipe to switch from the current output image to a new image.

NAM (Non-Additive Mix): Compare the current image and new image signals, and gives priority to the signal with the highest luminance level in the output.

For the first half of the transition, the current image is maintained at 100% and NAM is gradually performed for the new image. At the halfway point, NAM is performed for both images which are maintained at 100%. In the second half, the new image is maintained at 100% and NAM is performed while the current image is gradually reduced.

DME (Digital Multi Effects): Use DME effects to switch the image currently being output in a manner that appears as if it is being wiped (DME wipe).

Settings menu: [Effect] menu > [Effect Transition] (page II-15)

General Transition Settings ([Misc] menu)

You can set the transition rate and the color background (ColBg) with the items in the [Misc] menu. Press the MISC button in the menu control block to display the [Misc] menu.

Menu item	Description	Knob	Parameter	Meaning	Setting range
Transition Rate (1/2)	You can set the time (transition rate) it takes to switch videos when a transition is executed with the AUTO TRANS button, KEY TRANS button, or FTB button for each transition. Tips • The transition rate for effect transition can also be set under [Effect Transition] in the [Effect] menu. (See page II-15) • Key transition rates can be set under [Key Transition] in the [Key] menu. (See page II-23)	V2	Effect	Transition rate for effect transition	1 to 999 frames (30)
		V3	Key	Transition rate for key transition	1 to 999 frames (30)
		V4	FTB	Transition rate for FTB	1 to 999 frames (30)
Transition Rate (2/2)		V3	Aux1	Transition rate for Aux1	1 to 999 frames (30)
		V4	Aux2	Transition rate for Aux2	1 to 999 frames (30)
Color BKGD	A color signal can be generated within the unit and used as a single-color background. Color signals can be assigned to the cross point buttons (PGM button and PST/KEY button) and then used.	V2	Lum	Luminance	0.00 to 100.00
		V3	Sat	Saturation	0.00 to 100.00
		V4	Hue	Hue	359.99 to 0.00
Port Enable	Enable or disable the GPI and RS-232C ports which are used for operation from external devices. <i>For details on controls for external devices, see "Chapter 7: Controlling External Devices" (page II-44).</i>	V3	GPI	Enables/disables GPI port	Enbl (enable), Disbl (disable)
		V4	RS232C	Enables/disables RS-232C port (for future expansion)	Enbl (enable), Disbl (disable)

AUX Mixing

You can switch video via mixing (AUX Mixing) in the Aux blocks of this unit.

In addition, you can select the M/E program output as the input signal in the Aux blocks, allowing you to switch the video composed in the M/E block with another video via mixing in the Aux blocks and simulate the flexible video composition of a 2M/E switcher.

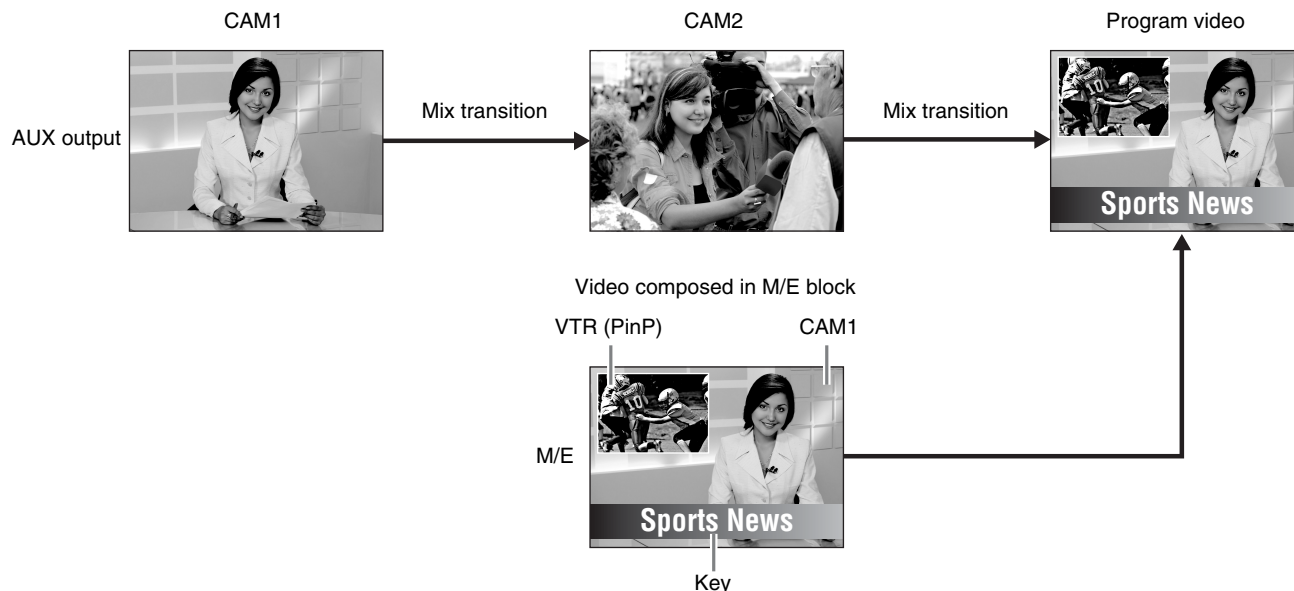

Tip

You can also use the output from the Aux blocks as the main video output. As illustrated above, you can adjust effects and keys in the M/E block while outputting the main output from an Aux block, and switch to that video when ready.

As an example, this section describes the procedure for using Aux1 as the main video output.

Preliminary settings

- 1 Select the Aux1 program as the main video output (program video output).
Settings menu: [Setup] menu > [Video (Output)] menu (*page II-54*)
- 2 Set Aux1 as the reference signal for the on-air tally.
Settings menu: [Setup] menu > [GPI/Tally] menu > [On Air Source] (*page II-47*)

Mixing operation

- 1 Press the AUX 1 bus delegation button.
- 2 Select the input material of the PGM bus in the PGM cross-point buttons.
- 3 Select the M/E program output in the PST/KEY cross-point buttons.
- 4 Execute the transition using the fader lever, CUT button, or AUTO TRANS button.

Tip

Aux1 and Aux2 settings are not stored in snapshots.

Setting Wipes

A wipe is a transition effect that switches to the next video by applying an effect that removes the program output video in a manner that appears as it is being wiped off with the video to be output next.

With this unit, you can make the following settings.

- *Selecting the Pattern and Direction for Wipes* (page II-10)
- *Making Detailed Adjustments to Wipe Patterns* (page II-10)
- *Adding the Edge to the Wipe Pattern* (page II-12)

This section describes wipe effects and basic operations for wipes.

Wipe settings are made in the [Effect] menu.

For details on the menu item, see “Details on [Effect] Menu” (page II-15).

Tip

The [Effect] menu does not appear in 3D mode.

Basic Operations for Wipe

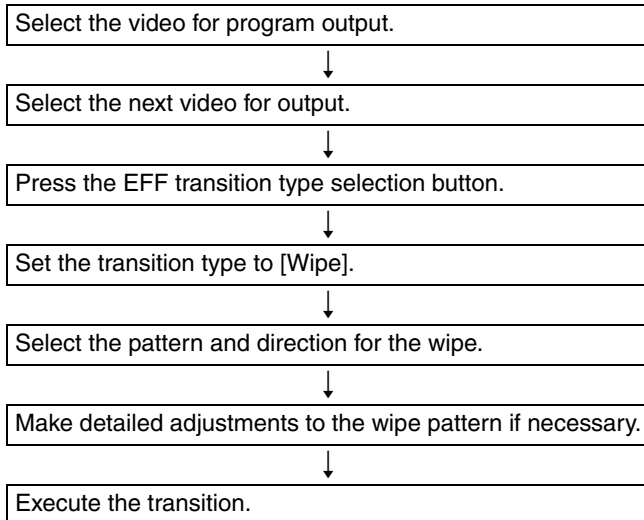

Selecting the Pattern and Direction for Wipes

A wipe can be set to proceed in either the normal wipe direction (normal) or reverse wipe direction (reverse). You can also specify normal and reverse to be switched each time a transition finishes (normal/reverse).

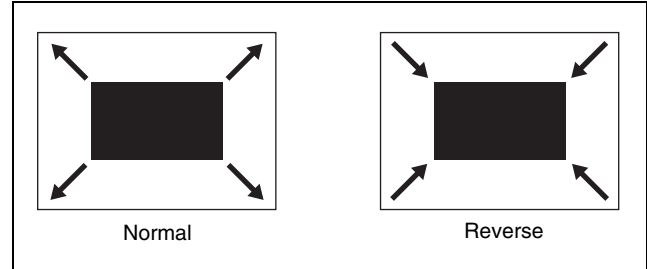

Selecting the wipe pattern

You can select the wipe pattern using one of the following three methods.

- Select from the patterns assigned to the numeric buttons (direct selection).

For details, see “Selecting Effects with the Numeric Keypad (Direct Selection)” (→ Basic Operation)

- Enter the pattern number with the numeric buttons.

For details, see “Specifying effects by pattern number” (→ Basic Operation).

- Specify the pattern number in the [Effect] menu.

Specifying the pattern number in the [Effect] menu

Settings menu: [Wipe Adjust] (page II-15)

For details on the wipe pattern numbers, see “Effect Pattern List” (→ Basic Operation).

Making Detailed Adjustments to Wipe Patterns

You can set the position of a wipe pattern and apply various variations and modifiers in the [Wipe Modify] menu.

To display the [Wipe Modify] menu

Display the [Effect] menu, turn the V1 knob to select [Wipe Adjust], and press this knob.

Setting the wipe position

The wipe position can be set in the [Wipe Modify] menu or with the X-Y pointer in the menu control block.

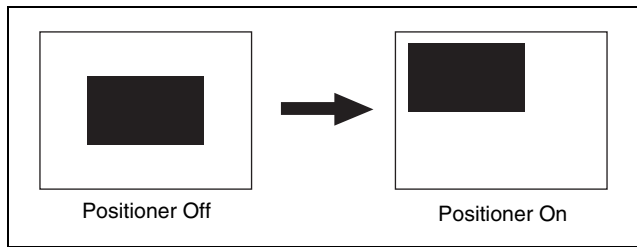

Settings menu: [Wipe Modify] menu > [Positioner] (page II-16), [Positioner Adjust] (page II-16)

To set the position with the X-Y pointer

Press the POS button in the menu control block so that it lights up and then adjust the position by controlling the X-Y pointer. If the F1 button is lit orange, press the F1 button to light it green.

Setting the rotation method of a wipe pattern

You can select from the following three rotation methods for wipe patterns.

Angle

Performs the wipe with the pattern inclined at a fixed angle.

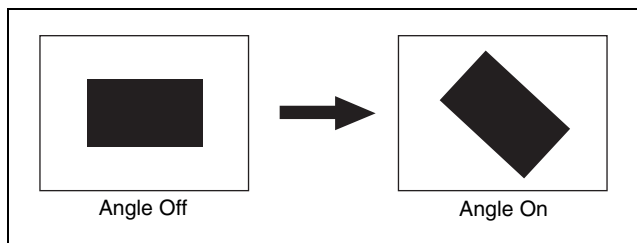

Speed

Rotates the pattern at a fixed speed during the transition.

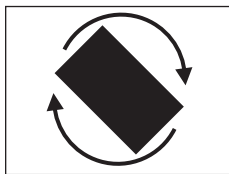

Magnitude

Rotates the pattern at only the set angle for one transition.

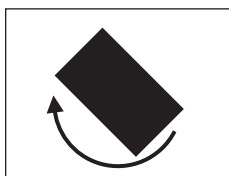

Settings menu: [Wipe Modify] menu > [Rotation] (page II-17), [Rotation Adjust] (page II-17)

Setting the aspect ratio of a wipe pattern

You can freely change the aspect ratio of a wipe pattern.

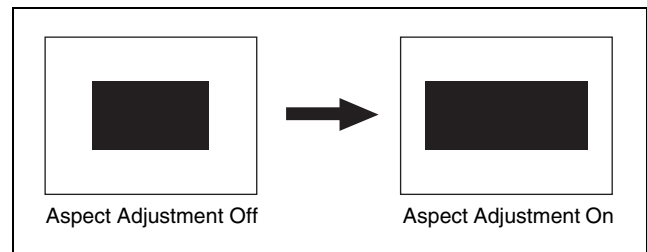

Settings menu: [Wipe Modify] menu > [Aspect] (page II-17)

Replicating a wipe pattern

The same pattern can be placed up to 63 times either horizontally or vertically, or in both directions.

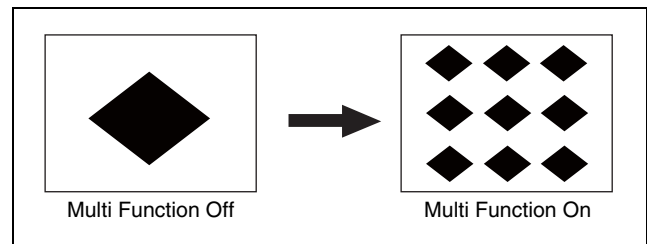

Furthermore, you can select from the following four methods for placing the patterns.

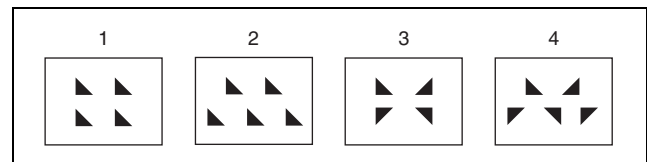

- 1: All of the patterns are oriented the same way
- 2: Even numbered rows are moved in the horizontal direction
- 3: Even numbered columns and even numbered rows are reversed
- 4: Even numbered columns and even numbered rows are reversed and even numbered rows are moved in the horizontal direction

Settings menu: [Wipe Modify] menu > [Multi] (page II-17), [Multi Adjust] (page II-17)

Adding the Edge to the Wipe Pattern

You can add a border around the pattern (border), defocus the edge around the pattern (soft), and defocus an added edge of border (soft border).

The edge color can also be adjusted.

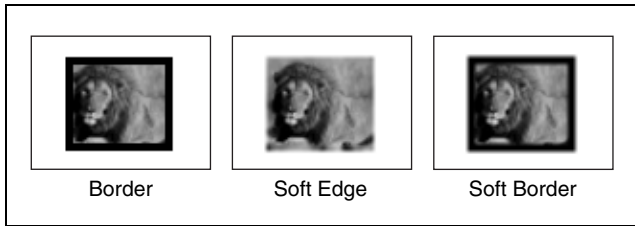

Border: You can adjust the width of the border.

Soft Edge: You can adjust the defocus condition for the edge.

Soft Border: You can adjust the width of the border and the defocus condition for the edge of the border.

Settings menu: [Wipe Edge] (page II-15), [Wipe Edge Color] (page II-15)

Setting DME Wipes

DME wipes are effects that use DME (digital multi effects) to switch the image currently being output in a manner that appears as if it is being wiped.

With this unit, you can make the following settings.

- *Selecting the Pattern and Direction for DME Wipes* (page II-12)
- *Making Detailed Adjustments to DME Wipe Patterns* (page II-13)
- *Adding an Edge to a DME Wipe Pattern* (page II-14)
- *Adjusting the Background Color of a DME Wipe* (page II-14)

This section describes DME wipe effects and basic operations for DME wipes.

DME wipe settings are made in the [Effect] menu.

For details on the menu item, see “Details on [Effect] Menu” (page II-15).

Basic Operations for DME Wipe

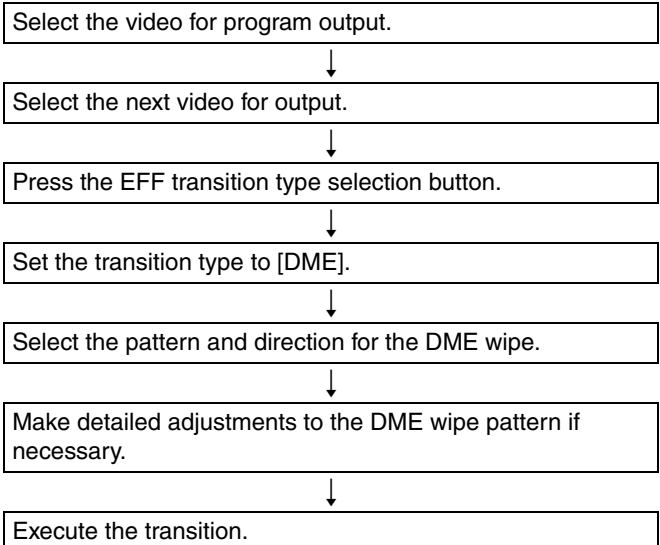

Selecting the Pattern and Direction for DME Wipes

For details on the pattern and direction for DME wipes, see “Selecting the Pattern and Direction for Wipes” (page II-10).

Settings menu: [DME Wipe Adjust] (page II-15)

Making Detailed Adjustments to DME Wipe Patterns

You can adjust the position of a DME wipe pattern, adjust the size of the sub-screen for during PinP, perform cropping to cut the edge of the image, and make other settings in the [DME Wipe Modify] menu.

To display the [DME Wipe Modify] menu

Display the [Effect] menu, turn the V1 knob to select [DME Wipe Adjust], and press this knob.

Setting the DME wipe position

The wipe position can be set in the [DME Wipe Modify] menu or with the X-Y pointer in the menu control block.

Settings menu: [DME Wipe Modify] menu > [Positioner] (*page II-18*), [Positioner Adjust] (*page II-18*)

To set the position with the X-Y pointer

Press the POS button in the menu control block so that it lights up, and then adjust the position by controlling the X-Y pointer.

Adjusting the size of the sub-screen used for Frame In/Out and PinP

You can adjust the size of the sub-screen that appears when you use the Frame In/Out and PinP DME wipe patterns.

Settings menu: [DME Wipe Modify] menu > [Size] (*page II-18*)

Cutting (cropping) the edge of an image

You can crop portions of the image that are unnecessary.

Note

The crop function is not available in the following cases.

- When the mosaic or defocus effect pattern is selected
- When the KEY next transition selection button is selected

Settings menu: [DME Wipe Modify] menu > [Crop H] (*page II-18*), [Crop V] (*page II-18*)

The cropping process when the transition is executed is as follows.

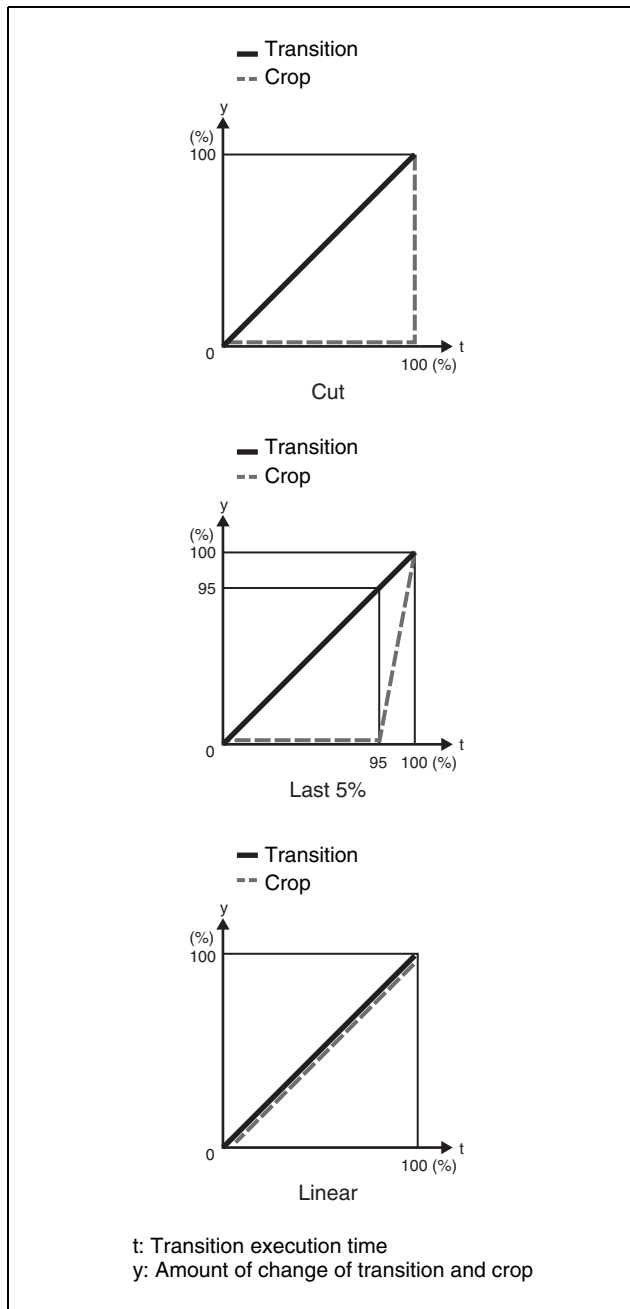

Cut: Cropping is maintained during transition execution and then removed at the point in time that the transition ends.

Last 5%: Cropping is maintained as is until the transition progresses to 95% and then removed during the remaining 5%.

Linear: Cropping is linearly removed from the start of the transition in accordance with the progression of the transition.

Adding an Edge to a DME Wipe Pattern

With a DME wipe, you can add a border around the pattern (border) and defocus the edge of an added border (soft border).

The edge color and background color can also be adjusted.

For details on how to add an edge, see “Adding the Edge to the Wipe Pattern” (page II-12).

Settings menu: [DME Wipe Edge], [DME Wipe Edge Color] (page II-16)

Adjusting the Background Color of a DME Wipe

You can adjust the background color of a DME wipe.

Settings menu: [DME Wipe Bkgd Color] (page II-16)

Tips

- The background color of the DME wipe can only be used for Flip Tumble DME wipe patterns.
- The background color of the DME wipe is shared with the edge color of the wipe pattern.

Details on [Effect] Menu

[Effect] Menu

Press the EFF button in the menu control block to display the [Effect] menu.

Menu item	Description	Knob	Parameter	Meaning	Setting range	Reference page	
Effect Transition	Set the transition rate and transition type that is used when you perform effect transitions.	V3	Rate	Transition rate when executed with the AUTO TRANS button	1 to 999 frames (30)	II-8	
		V4	Type	Transition type	Wipe, NAM, DME		
Wipe Adjust	Set the wipe direction and wipe pattern. You can also press the V1 knob to display the [Wipe Modify] menu (<i>page II-16</i>).	V1	Modify	Press the knob to display the [Wipe Modify] menu	–	II-10	
		V3	Direct	Wipe direction	Norm (normal), N/R (normal/reverse), Rev (reverse)		II-12
		V4	PtnNum	Wipe pattern number	1 to 24		
Wipe Edge	Add a border around the pattern (border), defocus the edge around the pattern (soft), and defocus an added border (soft border).	V2	Type	Wipe edge type	Off, Border, Soft (soft edge), S-Brdr (soft border)	II-12	
		V3	Width	Adjusts border width	0.00 to 100.00		
		V4	Soft	Defocus condition for edge	0.00 to 100.00		
Wipe Edge Color	Adjust the color of the wipe edge.	V2	Lum	Luminance	0.00 to 100.00	II-12	
		V3	Sat	Saturation	0.00 to 100.00		
		V4	Hue	Hue	359.99 to 0.00		
DME Wipe Adjust	Set the DME wipe direction and DME wipe pattern. You can also press the V1 knob to display the [DME Wipe Modify] menu (<i>page II-18</i>). Tip When the KEY next transition selection button is selected, 1101 to 1102 (Flip Tumble), 1251 (PinP), 1701 (Mosaic), and 1702 (Defocus) cannot be selected.	V1	Modify	Press the knob to display the [DME Wipe Modify] menu	–	II-12	
		V3	Direct	DME wipe direction	Norm (normal), N/R (normal/reverse), Rev (reverse)		
		V4	PtnNum	DME wipe pattern number	1001 to 1008 (Slide), 1021 to 1031 (Squeeze), 1041 to 1044 (Door), 1201 to 1208/1221 to 1224 (Frame In/Out), 1101 to 1102 (Flip Tumble), 1251 (PinP), 1701 (Mosaic), 1702 (Defocus)		

Menu item	Description	Knob	Parameter	Meaning	Setting range	Reference page
DME Wipe Edge	Add a border around the DME pattern (border), and defocus the edge of an added border (soft border).	V2	Type	DME wipe edge type	Off , Border, S-Brdr (soft border)	II-14
		V3	Width	Adjusts border width	0.00 to 100.00 (2.00)	
		V4	Soft	Defocus condition for edge	0.00 to 100.00	
DME Wipe Edge Color	Adjust the color of a DME wipe edge.	V2	Lum	Luminance	0.00 to 100.00 (14.63)	II-14
		V3	Sat	Saturation	0.00 to 100.00 (50.09)	
		V4	Hue	Hue	359.99 to 0.00 (349.83)	
DME Wipe Bkgd Color	Adjust the background color for the DME wipe.	V2	Lum	Background color luminance	0.00 to 100.00	II-14
		V3	Sat	Background color saturation	0.00 to 100.00	
		V4	Hue	Background color hue	359.99 to 0.00	

[Wipe Modify] Menu

Display the [Wipe Modify] menu by pressing the V1 knob while [Wipe Adjust] is selected.

Menu item	Description	Knob	Parameter	Meaning	Setting range	Reference page
Positioner	Turn the positioner for adjusting the wipe position on/off. If you also select [On] with the V3 knob, the pattern will move from the location to which the pattern was moved with the positioner to the center of the screen as a result of the transition. Tip The patterns for which the positioner can be used are as follows. 17, 18, 21, 22, 23, and 24	V3	AutoCT	Turns auto center function on/off	Off , On	II-11
		V4	Pos	Turns positioner on/off	Off , On	
Positioner Adjust	Adjust the wipe position. If you want to reset the setting value to "0.00," press the V4 knob.	V2	Pos H	Adjusts position in horizontal direction	-200.00 to +200.00 (0.00) (A negative value moves the pattern left, and a positive value moves it right)	II-11
		V3	Pos V	Adjusts position in vertical direction	-200.00 to +200.00 (0.00) (A negative value moves the pattern down, and a positive value moves it up)	
		V4	Center	Resets setting value to "0"	-	



Menu item	Description	Knob	Parameter	Meaning	Setting range	Reference page
Rotation	Set the rotation method of a wipe pattern.	V4	Rotate	Rotation type	Off , Angle, Speed, Mag (magnitude)	II-11
Rotation Adjust	Set the parameters depending on the rotation type selected in [Rotation]. <ul style="list-style-type: none"> When [Angle] is selected: Set [Angle]. When [Speed] is selected: Set [Speed]. When [Mag] is selected: Set [Angle] and [Mag]. <p>About setting values</p> <p>Angle: -100.00 corresponds to the state in which the pattern is rotated once counterclockwise, and +100.00 to the state in which the pattern is rotated once clockwise. 0.00 corresponds to a non-rotation state.</p> <p>Mag: -200.00 rotates the pattern twice counterclockwise, and +200.00 rotates the pattern twice clockwise. 0.00 does not rotate the pattern.</p> <p>Speed: -100.00 is the speed of one counterclockwise rotation per second, and +100.00 is the speed of one clockwise rotation per second. 0.00 corresponds to a stationary state.</p>	V2	Angle	<ul style="list-style-type: none"> Pattern inclination angle ([Angle]) Pattern inclination angle when transition starts ([Mag]) 	-100.00 to +100.00 (0.00)	II-11
		V3	Mag	Amount of rotation during transition	-200.00 to +200.00 (0.00)	
		V4	Speed	Pattern rotation speed	-100.00 to +100.00 (0.00)	
Aspect	Change the aspect ratio of a wipe pattern. Setting the aspect ratio to a negative value stretches the pattern vertically to make it longer in the vertical direction, and setting the aspect ratio to a positive value stretches the pattern horizontally to make it longer in the horizontal direction.	V3	Aspect	Turns aspect adjustment on/off	Off , On	II-11
		V4	Ratio	Adjusts aspect ratio	-100.00 to +100.00 (0.00)	
Multi	Turn the multi function for replicating wipe patterns on/off.	V4	Multi	Turns multi function on/off	Off , On	II-11
Multi Adjust	The same pattern can be placed up to 63 times either horizontally or vertically, or in both directions.	V2	H Mult	Number of patterns to place in horizontal direction	1 to 63	II-11
		V3	V Mult	Number of patterns to place in vertical direction	1 to 63	
		V4	InvTyp	Pattern placement method	1 to 4	

[DME Wipe Modify] Menu

Display the [DME Wipe Modify] menu by pressing the V1 knob while [DME Wipe Adjust] is selected.

Menu item	Description	Knob	Parameter	Meaning	Setting range	Reference page
Positioner	Turn the positioner for adjusting the DME wipe position on/off. Tip The patterns for which the positioner can be used are as follows. 1031, 1201 to 1208, 1221 to 1224, and 1251	V4	Pos	Turns positioner on/off	Off, On	II-13
Positioner Adjust	Adjust the DME wipe position. If you want to reset the setting value to "0.00," press the V4 knob.	V2	Pos H	Adjusts position in horizontal direction	-200.00 to +200.00 (0.00) (A negative value moves the pattern left, and a positive value moves it right)	II-13
		V3	Pos V	Adjusts position in vertical direction	-200.00 to +200.00 (0.00) (A negative value moves the pattern down, and a positive value moves it up)	
		V4	Center	Resets setting value to "0"	-	
Size	You can adjust the size of the sub-screen when you use the 1201 to 1208 (Frame In/Out), 1221 to 1224 (Frame In/Out), and 1251 (PinP) DME wipe patterns. Notes on setting values Param: Set the enlarge/reduce ratio as a percentage. The 100.00 setting is equal to the size of the input image.	V3	Size	Turns size adjustment on/off	Off, On	II-13
		V4	Param	Adjusts size	0.00 to 200.00 (100.00)	
Crop H	Turn the crop function on/off, and set the left and right positions used when cropping unnecessary portions of an image.	V2	Crop	Turns crop on/off	Off, On	II-13
		V3	Left	Position for cutting left portion of image	-100.00 to +100.00	
		V4	Right	Position for cutting right portion of image	-100.00 to +100.00	
Crop V	Set the action performed when a transition is executed, and set the top and bottom positions used when cropping unnecessary portions of an image.	V2	Trans	Action when transition executed	Cut, Last5% , Linear	II-13
		V3	Top	Position for cutting top portion of image	-100.00 to +100.00	
		V4	Bottom	Position for cutting bottom portion of image	-100.00 to +100.00	

Tip

The crop function is not available in the following cases.

- When the 1701 (Mosaic) or 1702 (Defocus) effect pattern is selected
- When the KEY next transition selection button is selected

Setting Keys

A key is a function for cutting out the background image and then inserting an image or text in that portion. The signal for cutting out the background is called a key source, the signal for filling the cutout portion is called a key fill, and the block for processing a key is called a keyer.

This section describes how to make detailed adjustments for keys.

With this unit, you can make the following settings for keys.

- *Basic Operations for Keys* (page II-19)
- *Setting Key Transitions* (page II-20)
- *Selecting the Pattern and Direction for Key Wipes* (page II-20)
- *Making Detailed Adjustments to Key Wipe Patterns* (page II-20)
- *Setting Key DME Wipes* (page II-20)
- *Making Detailed Adjustments to Key DME Wipe Patterns* (page II-21)
- *Selecting Key Types* (page II-21)
- *Making Detailed Adjustments to the Luminance Key* (page II-21)
- *Making Detailed Adjustments to the Linear Key* (page II-21)
- *Making Detailed Adjustments to the Chroma Key* (page II-21)
- *Setting the Key Fill and Key Source* (page II-21)
- *Setting a Mask for a Key* (page II-22)
- *Adding an Edge to a Key* (page II-22)
- *Adjusting the Size and Position of the Key* (page II-22)

For the basic operating procedures of the luminance key and chroma key, see “Composing Images with Keys” (→ Basic Operation).

Make the key and the key transition settings in the [Key] menu.

For details on the [Key] menu item, see “Details on [Key] Menu” (page II-23).

Tip

In 3D mode, the [Key] menu is not displayed.

Basic Operations for Keys

Use the following procedure to perform basic operations for keys.

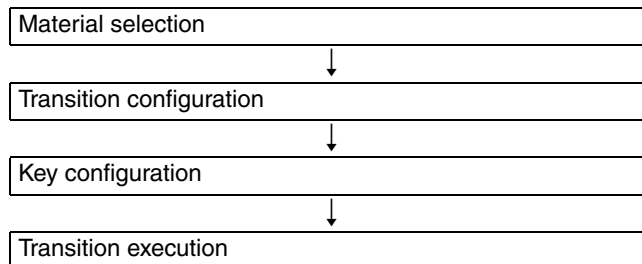

Depending on where you want to perform the key transition, perform one of the following two variations for basic key operations.

- Effect transition (select KEY next transition button) (page II-19)
- Key transition (page II-20)

Effect transition

Material selection

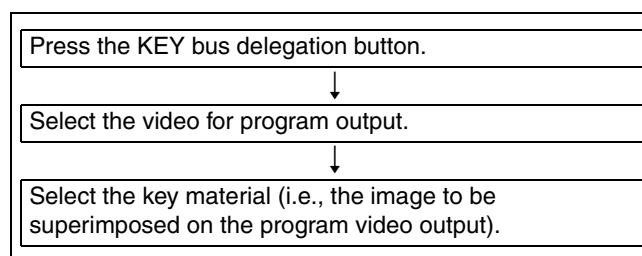

Transition configuration

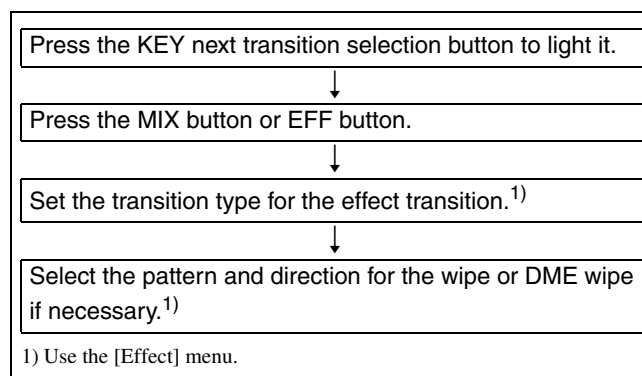

Key configuration

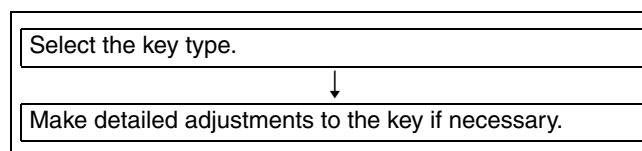

Transition execution ↓

Execute the transition using the fader lever, CUT button, or AUTO TRANS button.

Key transition**Material selection**

Press the KEY bus delegation button.

Select the video for program output.

Select the key material (i.e., the image to be superimposed on the program video output).

Transition configuration ↓

Set the transition type for the key transition.¹⁾

Select the pattern and direction for the key wipe or key DME wipe if necessary.¹⁾

1) Use the [Key] menu.

Key configuration ↓

Select the key type.

Make detailed adjustments to the key if necessary.

Transition execution ↓

Execute the transition using the KEY TRANS button.

Setting Key Transitions

Set the key transition rate and key transition type for when a key transition is performed.

You can select any of the following transition types.

Cut: Quickly insert (cut in) or remove (cut out) the key.

Mix: Gradually insert (fade in) or remove (fade out) the key.

Wipe: Use the wipe to cut out the background and then embed a key.

DME (Digital Multi Effects): Use a DME effect and apply the same effect as the DME wipe to the key (key DME wipe).

Settings menu: [Key Transition] (page II-23)

Selecting the Pattern and Direction for Key Wipes

You can cut out the background from a wipe pattern selected for a key transition and then embed a key.

Settings menu: [Key Wipe Modify] (page II-24)

For details on the wipe directions, see “Selecting the Pattern and Direction for Wipes” (page II-10).

For details on the wipe pattern numbers, see “Effect Pattern List” (→ Basic Operation).

Making Detailed Adjustments to Key Wipe Patterns

You can set the position of a wipe pattern, and apply various variations and modifiers in [Key Wipe].

To display the [Key Wipe] menu

Display the [Key] menu, turn the V1 knob to select [Key Wipe], and press this knob.

The setting items in the [Key Wipe Modify] menu are the same as those of [Wipe Modify] in the [Effect] menu. For details on the setting items, see the corresponding sections of “Making Detailed Adjustments to Wipe Patterns” (page II-10).

Setting Key DME Wipes

For a key, you can make the same settings as with DME wipe.

Settings menu: [Key DME Wipe] (page II-24)

For details on the DME wipe directions, see “Selecting the Pattern and Direction for Wipes” (page II-10).

For details on the wipe pattern numbers, see “Effect Pattern List” (→ Basic Operation).

Making Detailed Adjustments to Key DME Wipe Patterns

You can adjust the position of a key DME wipe pattern and adjust the size of a sub-screen for during Frame In/Out and PinP in the [Key DME Wipe Modify] menu.

To display the [Key DME Wipe Modify] menu

Display the [Key] menu, turn the V1 knob to select [Key DME Wipe], and press this knob.

The setting items that can be configured in the [Key DME Wipe Modify] menu are the same as those of the [DME Wipe Modify] menu for a DME wipe (except for the crop item). See the corresponding sections of “Making Detailed Adjustments to DME Wipe Patterns” (page II-13).

Selecting Key Types

Select the key types to cut off the images.

You can select any of the following key types.

Lum (luminance key) / Lin (linear key): Use these when inserting titles or logos onto the image. Use brightness signals such as those for black and white text as the key source.

Tip

Linear keys have a reduced variability in gain that allows more precise adjustment when compared to luminance keys.

Chr (chroma key): Use this when combining images of people with a background image, for example. Create the key source from a particular color within the input image.

Settings menu: [Key Type Select] (page II-23)

Making Detailed Adjustments to the Luminance Key

You can make detailed adjustments for the cutout condition of the background, the key density, and other settings for composing video with luminance keys.

Settings menu: [Lum Key Adjust (1/2)] (page II-23), [Lum Key Adjust (2/2)] (page II-23), [Lum Key Mode] (page II-23)

Making Detailed Adjustments to the Linear Key

You can make detailed adjustments for the cutout condition of the background, the key density, and other settings for composing video with linear keys.

Settings menu: [Lin Key Adjust (1/2)] (page II-23), [Lin Key Adjust (2/2)] (page II-24), [Lin Key Mode] (page II-24)

Making Detailed Adjustments to the Chroma Key

When, for example, you want to fine-tune the results of automatic chroma key adjustment, you can specify each chroma key setting manually in the [Manual Chromakey] menu. You can also replace background colors (typically blue) that seep into the outline portions of the video being combined (such as into a subject's hair) with colors such as gray to make them less conspicuous.

For details on automatic chroma key adjustment, see “Composing Images with Chroma Keys” (→ Basic Operation).

To display the [Manual Chromakey] menu

Display the [Key] menu, turn the V1 knob to select [Chromakey Manual Adj], and press this knob.

For details on the [Manual Chromakey] menu, see “[Manual Chromakey] Menu” (page II-28).

Setting the Key Fill and Key Source

Select the signal to use for the key fill and the signal selection mode to use for the key source.

Settings menu: [Key Fill/Src Select] (page II-23), [Key Fill Mat Adjust] (page II-23)

Key source selection modes

Self: Selects the signal of the key source bus as the key source.

If the chroma key is selected as the key type, select [Self].

Auto: Automatically selects the signal of the key fill bus and the paired signal assigned to a cross point button as the key source.

Split: Allows you to select the key source bus signal separately from the key fill bus signal.

For details on selection, see “Selecting the key fill and key source separately” (→ Basic Operation).

The key fill and key source pairs selected when [Auto] is selected are as follows.

Key fill	Key source
Frame memory video	Frame memory key
Black video	White video ¹⁾
Signals other than the above	Same signal as key fill

1) If you perform keying with white video as the key source, the key fill video will fill the entire screen.

Key fill selection modes

Bus: Signal selected with a cross point button

Matte: Signal generated with the color matte generator within the unit (you can adjust the color under [Key Fill Mat Adjust])

Setting a Mask for a Key

Key mask is a function for masking a portion of the key signal.

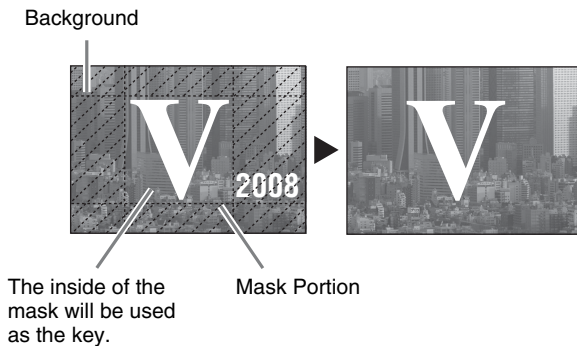

Settings menu: [Key Mask] (page II-25)

Adding an Edge to a Key

You can add a border to the edge of the key (border) and defocus the edge of the key (soft).

Note

When you add a border to a key, the positions of the key fill and key source will move downward.

Setting modifiers for the key edge

Turn drop mode on or off and set the type of modifier.

- If you turn drop mode on, the position of the key fill and key source will move downward, regardless of whether borders are added. If you do not want to move the position of the key in response to whether key border is turned on or off, turn drop mode on.
- You can select any of the following modifiers.

Normal



Border



Normal: The state in which a border around the key is not added.

Border: Allows you to add a border around the key and adjust the width and border density.

Settings menu: [Key Edge Type] (page II-25), [Border Adjust] (page II-25), [Border Matte Adjust] (page II-25), [Key Soft Edge] (page II-25)

Adjusting the Size and Position of the Key

Under the [Resizer] menu, you can apply effects, such as reducing, enlarging, moving, and changing the aspect ratio, to the created key portion in a similar manner as DME (resize function).

Notes

- If a resize effect is applied to the key, there will be a one-frame delay in the image.
- Of the DME wipe, key DME wipe, and resize functions, only one can be used at any one time.

To enable the resize function

Display the [Key] menu, turn the V1 knob to select [Resizer], and turn the V4 knob to select [On]. (See page II-23)

To display the [Resizer] menu

Display the [Key] menu, turn the V1 knob to select [Resizer], and press this knob.

For details on the [Resizer] menu, see "[Resizer] Menu" (page II-26).

Details on [Key] Menu

[Key] Menu

Press the KEY button in the menu control block to display the [Key] menu.

Menu item	Description	Knob	Parameter	Meaning	Setting range	Reference page
Key Transition	Set the transition rate and transition type used when key transition is executed with the KEY TRANS button.	V3	Rate	Transition rate	1 to 999 (30)	II-20
		V4	Type	Transition type	Cut, Mix , Wipe, DME	
Key Type Select	Select the key type to cut off the images.	V4	Type	Key type	Lum (Luminance key), Lin (Linear key), Chr (Chroma key)	II-21
Resizer	Select whether to use the resize function that applies effects, such as reducing, enlarging, moving, and changing the aspect ratio, to the created key portion in a similar manner as DME. You can also press the V1 knob to display the [Resizer] menu (<i>page II-26</i>).	V1	Select	Press the knob to display the [Resizer] menu	–	II-22
		V4	Resize	Turns resizer function on/off	Off , On	
Key Fill/Src Select	Select the signal to use for the key fill and the signal selection mode to use for the key source.	V3	Source	Selection mode of key source	Self, Auto , Split	II-21
		V4	Fill	Signal to use as key fill	Bus , Matte	
Key Fill Mat Adjust	Adjust the color of the key fill matte.	V2	Lum	Color matte luminance	0.00 to 100.00	II-21
		V3	Sat	Color matte saturation	0.00 to 100.00	
		V4	Hue	Color matte hue	359.99 to 0.00	
Lum Key Adjust (1/2)	Adjust the background cutout condition and outline sharpness of the luminance key.	V3	Clip	Cutout condition for background (clip value)	+109.59 to –7.31 (0.00)	–
		V4	Gain	Outline sharpness (gain value)	–100.00 to +100.00 (0.00)	
Lum Key Adjust (2/2)	Adjust the luminance key density.	V4	Dens	Key density	0 to 100.00	–
Lum Key Mode	Turn the clean mode for the luminance key on/off. When the clean mode is on, the key source does not affect the key fill, which is added unchanged to the background. Tip Clean mode is effective when you are using signals consisting of a paired key fill and key source, as with a character generator.	V4	Clean	Turns clean mode on/off	Off , On	–
Lin Key Adjust (1/2)	Adjust the background cutout condition and outline sharpness of the linear key.	V3	Clip	Cutout condition for background (clip value)	+109.59 to –7.31 (0.00)	–
		V4	Gain	Outline sharpness (gain value)	–100.00 to +100.00 (0.00)	

Menu item	Description	Knob	Parameter	Meaning	Setting range	Reference page
Lin Key Adjust (2/2)	Adjust the linear key density.	V4	Dens	Key density	0 to 100.00	–
Lin Key Mode	Turn the clean mode for the linear key on/off. When the clean mode is on, the key source does not affect the key fill, which is added unchanged to the background. Tip Clean mode is effective when you are using signals consisting of a paired key fill and key source, as with a character generator.	V4	Clean	Turns clean mode on/off	Off , On	–
Chromakey Auto Adj	Display the [Auto Chromakey] menu (<i>page II-27</i>) that allows you to specify a part of the foreground video (e.g., the blue background color) and use it as a reference for automatically creating the chroma key image.	V1	Auto	Press the knob to display the [Auto Chromakey] menu	–	Operating Instructions (Basic Operation)
Chromakey Manual Adj	Display the [Manual Chromakey] menu (<i>page II-28</i>) for making detailed adjustments to the chroma key.	V1	Manual	Press the knob to display the [Manual Chromakey] menu	–	II-21
Key Invert	Invert white and black of the key source.	V4	Invert	Turns key source inversion on/off	Off , On	–
Key Wipe	Set the key wipe direction and key wipe pattern. You can also press the V1 knob to display the [Key Wipe Modify] menu (<i>page II-29</i>).	V1	Modify	Press the knob to display the [Key Wipe Modify] menu	–	II-20
		V3	Direct	Key wipe direction	Norm (normal), N/R (normal/reverse), Rev (reverse)	II-20
		V4	PtnNum	Key wipe pattern number	1 to 24	
Key Wipe Edge	Defocus the edge of a key wipe pattern (soft edge).	V3	Soft	Turns soft edge on/off	Off , On	–
		V4	Param	Defocus condition for edge	0.00 to 100.00	
Key DME Wipe	Set the key DME wipe direction and key DME wipe pattern. You can also press the V1 knob to display the [Key DME Wipe Modify] menu (<i>page II-30</i>).	V1	Modify	Press the knob to display the [Key DME Wipe Modify] menu	–	II-20
		V3	Direct	Key DME wipe direction	Norm (normal), N/R (normal/reverse), Rev (reverse)	
		V4	PtnNum	Key DME wipe pattern number	1001 to 1008 (Slide), 1021 to 1031 (Squeeze), 1041 to 1044 (Door), 1201 to 1208, 1221 to 1224 (Frame In/Out)	

Menu item	Description	Knob	Parameter	Meaning	Setting range	Reference page
Key Mask	Set the key mask function for masking a portion of a key signal.	V3	Mask	Turns mask function on/off	Off , On	II-22
		V4	Invert	On/off of mask inversion	Off , On	
Key Mask Box H	Specify the left and right positions of the mask box.	V3	Left	Position of left side	-100.00 to +100.00 (-50.00)	II-22
		V4	Right	Position of right side	-100.00 to +100.00 (+50.00)	
Key Mask Box V	Specify the top and bottom positions of the mask box.	V3	Top	Position of top side	-100.00 to +100.00 (+50.00)	II-22
		V4	Bottom	Position of bottom side	-100.00 to +100.00 (-50.00)	
Key Edge Type	Turn drop mode on or off and set modifier for the key edge.	V3	Drop	Turns drop mode on/off	Off , On	II-22
		V4	Type	Key edge type	Norm (normal), Border	
Border Adjust	Adjust the density and width of the border.	V3	Dens	Border density	0.00 to 100.00	II-22
		V4	Width	Border width	0.00 to 4.00	
Border Matte Adjust	Adjust the color of the border matte.	V2	Lum	Border matte luminance	0.00 to 100.00	II-22
		V3	Sat	Border matte saturation	0.00 to 100.00	
		V4	Hue	Border matte hue	359.99 to 0.00	
Key Soft Edge	Defocus the edge of the key (soft edge). Turn on the key edge and adjust the defocus condition of the edge.	V3	Soft	Turns soft edge on/off	Off , On	II-22
		V4	Param	Defocus condition for edge	0.00 to 100.00	
Fine Key	Turn the fine key function for fine-tuning the position of the key signal edge on/off.	V4	Fine	Turns fine key function on/off	Off , On	-
Fine Key Adjust H	When the fine key function is on, fine-tune the left and right positions of the key signal edge.	V3	Left	Position of left side	-2.00 to +2.00 (0.00)	-
		V4	Right	Position of right side	-2.00 to +2.00 (0.00)	
Fine Key Adjust V	When the fine key function is on, fine-tune the top and bottom positions of the key signal edge.	V3	Top	Position of top side	-2.00 to +2.00 (0.00)	-
		V4	Bottom	Position of bottom side	-2.00 to +2.00 (0.00)	

[Resizer] Menu

Display the [Resizer] menu by pressing the V1 knob while [Resizer] (page II-23) is selected.

Menu item	Description	Knob	Parameter	Meaning	Setting range	Reference page
Rotation Mode	Select whether the resizer function moves in 2D or 3D. Tip Depending on this setting, the adjustment ranges for the following [Location], [Aspect], and [Rotation] settings will vary.	V3	Axis	Selects rotation axis for 3D transform	X, Y	-
		V4	Enable	Switches between 2D transform and 3D transform	Off (2D transform), On (3D transform)	
Location	Reduce/enlarge and move the key. Tips <ul style="list-style-type: none"> The setting range for the horizontal direction differs between HD/SD 4:3 and SD 16:9. The setting range for the vertical direction differs between HD/SD 4:3, SD 16:9, and 3D. When the F1 button is lit orange, you can also move the key using the X-Y pointer. 	V2	Loc X	Moves key in horizontal direction	-100.00 to +100.00 (0.00)	-
		V3	Loc Y	Moves key in vertical direction	<ul style="list-style-type: none"> When [Rotation Mode] is [Off], -100.00 to +100.00 (0.00) When [Rotation Mode] is [On], -9.00 to 9.00 (0.00) 	
		V4	Size	Reduces/enlarges key	<ul style="list-style-type: none"> When [Rotation Mode] is [Off], 0.00 to 100.00 (1.00) When [Rotation Mode] is [On], 0.00 to 1.00 	
Aspect	Change the aspect ratio of a key.	V2	Asp X	Changes size in horizontal direction	<ul style="list-style-type: none"> When [Rotation Mode] is [Off], 0.00 to 100.00 (1.00) When [Rotation Mode] is [On], fixed at 1.00 (adjustment is disabled) 	-
		V3	Asp Y	Changes size in vertical direction	<ul style="list-style-type: none"> When [Rotation Mode] is [Off], 0.00 to 100.00 (1.00) When [Rotation Mode] is [On], fixed at 1.00 (adjustment is disabled) 	
		V4	Ratio	Changes aspect ratio	<ul style="list-style-type: none"> When [Rotation Mode] is [Off], 0.00 to 2.00 (1.00) When [Rotation Mode] is [On], fixed at 1.00 (adjustment is disabled) 	

Menu item	Description	Knob	Parameter	Meaning	Setting range	Reference page
Rotation	Rotate the key and adjust perspective.	V2	Rot X	Amount of X-axis rotation	<ul style="list-style-type: none"> When [Rotation Mode] is [Off], fixed at 0.00 (adjustment is disabled) When [Rotation Mode] is [On], -100.00 to +100.00 (0.00) 	-
		V3	Rot Y	Amount of Y-axis rotation	<ul style="list-style-type: none"> When [Rotation Mode] is [Off], fixed at 0.00 (adjustment is disabled) When [Rotation Mode] is [On], -100.00 to +100.00 (0.00) 	
		V4	Pers	Perspective	<ul style="list-style-type: none"> When [Rotation Mode] is [Off], fixed at 1.00 (adjustment is disabled) When [Rotation Mode] is [On], 0.00 to 1.00 	

[Auto Chromakey] Menu

Display the [Auto Chromakey] menu by pressing the V1 knob while [Chromakey Auto Adj] (*page II-24*) is selected.

Menu item	Description	Knob	Parameter	Meaning	Setting range	Reference page
Sample Mark	Display the sample mark (i.e., white box) for specifying the cutout color (i.e., color to be used as the reference of chroma key).	V4	Mark	Turns sample mark display on/off	Off, On	Basic Operation
Sample Mark Adjust	Adjust the size and position of the sample mark. Tip Depending on the size setting, the setting ranges for the horizontal and vertical positions will vary.	V2	Pos H	Position in horizontal direction	-100.00 to +100.00 (0.00)	Basic Operation
		V3	Pos V	Position in vertical direction	-100.00 to +100.00 (0.00)	
		V4	Size	Size	1.00 to 100.00 (25.00)	
Auto Adjust Execute	Execute auto chroma key. When you press the V4 knob, auto chroma key is executed using the color specified with the sample mark as a reference, and the composed image is output.	V4	Start	Press the knob to execute auto chroma key.	-	Basic Operation

[Manual Chromakey] Menu

Display the [Manual Chromakey] menu by pressing the V1 knob while [Chromakey Manual Adj] (page II-24) is selected.

Menu item	Description	Knob	Parameter	Meaning	Setting range	Reference page
Chr Key Adjust (1/2)	Adjust the background cutout condition, outline sharpness, and other settings.	V2	Hue	Hue of color you want to cut out	359.99 to 0.00 (0.00)	-
		V3	Clip	Saturation of color you want to cut out	0.00 to 100.00 (50.00)	
		V4	Gain	Outline sharpness (gain value)	0.00 to 100.00 (0.00)	
Chr Key Adjust (2/2)	Adjust the chroma key density.	V4	Dens	Key density	0 to 100.00	-
Color Cancel	Turn on/off the color cancel function that removes background colors (e.g., blue screen) that seep into the outline areas of the subject of the video being combined.	V4	Cancel	Turns color cancel function on/off	Off, On	-
Color Cancel Adjust	Adjust the color that will be removed via color cancel.	V2	Lum	Brightness offset of the color to be canceled	0.00 to 100.00	-
		V3	Sat	Saturation of color to be canceled	0.00 to 100.00	
		V4	Hue	Hue of color to be canceled	359.99 to 0.00	
Chr Key Window	Turn on/off the window function that allows you to adjust the detection range for the color you want to remove. Tip When the window function is off, image adjustment is made within the range of the default values.	V4	Window	Turns window function on/off	Off , On	-
Chr Key Window Adj	Adjust the window shape.	V3	Crop	Position for cropping the top of the window	100.00 to 0.00 (75.00)	-
		V4	Angle	Angle at which the window is opened	180.00 to 0.00 (180.00)	

[Key Wipe Modify] Menu

Display the [Key Wipe Modify] menu by pressing the V1 knob while [Key Wipe] (page II-24) is selected.

Menu item	Description	Knob	Parameter	Meaning	Setting range	Reference page
Positioner	Turn the positioner for adjusting the key wipe position on/off. If you also select [On] with the V3 knob, the pattern will move from the location to which the pattern was moved with the positioner to the center of the screen as a result of the transition. Tip The patterns for which the positioner can be used are as follows. 17, 18, 21, 22, 23, and 24	V3	AutoCT	Turns auto center function on/off	Off, On	-
		V4	Pos	Turns positioner on/off	Off, On	
Positioner Adjust	Adjust the key wipe position. If you want to reset the setting value to "0.00," press the V4 knob. Notes on setting values Pos H: Negative values adjust the position to the left, positive values to the right. Pos V: Negative values adjust the position to the bottom, positive values to the top.	V2	Pos H	Adjusts position in horizontal direction	-200.00 to +200.00 (0.00)	-
		V3	Pos V	Adjusts position in vertical direction	-200.00 to +200.00 (0.00)	
		V4	Center	Resets setting value to "0"	-	
Rotation	Set the rotation method of a key wipe pattern.	V4	Rotate	Rotation type	Off, Angle, Speed, Mag (magnitude)	-
Rotation Adjust	Set the parameters depending on the rotation type selected in [Rotation]. • When [Angle] is selected: Set [Angle]. • When [Speed] is selected: Set [Speed]. • When [Mag] is selected: Set [Angle] and [Mag]. About setting values Angle: -100.00 corresponds to the state in which the pattern is rotated once counterclockwise, and +100.00 to the state in which the pattern is rotated once clockwise. 0.00 corresponds to a non-rotation state. Mag: -200.00 rotates the pattern twice counterclockwise, and +200.00 rotates the pattern twice clockwise. 0.00 does not rotate the pattern. Speed: -100.00 is the speed of one counterclockwise rotation per second, and +100.00 is the speed of one clockwise rotation per second. 0.00 corresponds to a stationary state.	V2	Angle	<ul style="list-style-type: none"> Pattern inclination angle ([Angle]) Pattern inclination angle when transition starts ([Mag]) 	-100.00 to +100.00 (0.00)	II-11
		V3	Mag	Amount of rotation during transition	-200.00 to +200.00 (0.00)	
		V4	Speed	Pattern rotation speed	-100.00 to +100.00 (0.00)	

Menu item	Description	Knob	Parameter	Meaning	Setting range	Reference page
Aspect	Change the aspect ratio of a key wipe pattern. Setting the aspect ratio to a negative value stretches the pattern vertically to make it longer in the vertical direction, and setting the aspect ratio to a positive value stretches the pattern horizontally to make it longer in the horizontal direction.	V3	Aspect	Turns aspect adjustment on/off	Off, On	II-11
		V4	Ratio	Adjusts aspect ratio	-100.00 to +100.00 (0.00)	
Multi	Turn the multi function for replicating key wipe patterns on/off.	V4	Multi	Turns multi function on/off	Off, On	II-11
Multi Adjust	The same pattern can be placed up to 63 times either horizontally or vertically, or in both directions.	V2	H Mult	Number of patterns to place in horizontal direction	1 to 63	II-11
		V3	V Mult	Number of patterns to place in vertical direction	1 to 63	
		V4	InvTyp	Pattern placement method	1 to 4	

[Key DME Wipe Modify] Menu

Display the [Key DME Wipe Modify] menu by pressing the V1 knob while [Key DME Wipe] (page II-24) is selected.

Menu item	Description	Knob	Parameter	Meaning	Setting range	Reference page
Positioner	Turn the positioner for adjusting the key DME wipe position on/off. Tip The positioner can be used for the following patterns. 1031, 1201 to 1208, and 1221 to 1224	V4	Pos	Turns positioner on/off	Off, On	–
Positioner Adjust	Adjust the key DME wipe position. If you want to reset the setting value to “0.00,” press the V4 knob. Notes on setting values Pos H: Negative values adjust the position to the left, positive values to the right. Pos V: Negative values adjust the position to the bottom, positive values to the top.	V2	Pos H	Adjusts position in horizontal direction	-200.00 to +200.00 (0.00)	–
		V3	Pos V	Adjusts position in vertical direction	-200.00 to +200.00 (0.00)	
		V4	Center	Resets setting value to “0”	–	
Size	Adjusts the size of the sub-screen when you use the 1201 to 1208 (Frame In/Out) and 1221 to 1224 (Frame In/Out) key DME wipe patterns. Notes on setting values Param: Set the enlarge/reduce ratio as a percentage. The 100.00 setting is equal to the size of the input image.	V3	Size	Turns size adjustment on/off	Off, On	–
		V4	Param	Adjusts size	0.00 to 200.00 (100.00)	

Overview

You can adjust the audio input in detail, set the audio levels, and specify the connectors to use for audio output for each audio channel.

Adjust and set the audio from the [Audio Channel] menu for each audio channel.

To display the [Audio Channel] menu

Press the ACCESS/PFL button in the same column as the channel fader assigned to the audio channel you want to adjust.

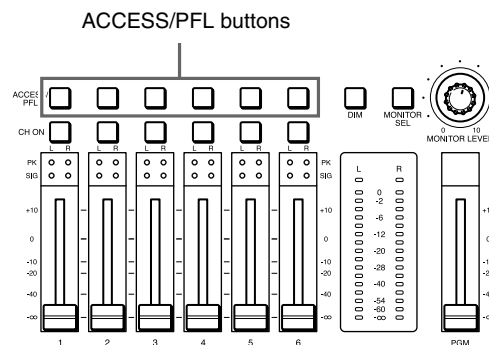

For details on assigning an input signal to each channel fader, see “Assigning Audio Input Signals to the Channel Faders” (→ Basic Operation).

Details on [Audio Channel] Menu

Menu item	Description	Knob	Parameter	Meaning	Setting range	Reference page
Input Trim	Adjust the audio input signal levels. You can individually adjust the assigned channels of the audio signals input to this unit.	V4	Level	Adjusts input level	-15 dB to +15 dB (0 dB)	-
Filter	Cut high frequency and low frequency. Use these settings to suppress noise, etc.	V3	L Cut	Cuts low frequency (100 Hz or less)	Off, On	-
		V4	H Cut	Cuts high frequency (8 kHz or more)	Off, On	

Menu item	Description	Knob	Parameter	Meaning	Setting range	Reference page
Equalizer High	Use the equalizer function to adjust the audio quality by setting the high-frequency band.	V2	EQ H	Turns audio quality adjustment of high-frequency band on/off	Off, On	–
		V3	Freq	Center frequency of high-frequency band (kHz)	1.30 k to 17.40 k (4.75 k)	
		V4	Level	Level of high-frequency band	–15 dB to +15 dB (0 dB)	
Equalizer Mid	Use the equalizer function to adjust the audio quality by setting the middle-frequency band.	V2	EQ M	Turns audio quality adjustment of middle-frequency band on/off	Off, On	–
		V3	Freq	Center frequency of middle-frequency band (kHz)	260.0 k to 6.40 k (1.28 k)	
		V4	Level	Level of middle-frequency band	–15 dB to +15 dB (0 dB)	
Equalizer Low	Use the equalizer function to adjust the audio quality by setting the low-frequency band.	V2	EQ L	Turns audio quality adjustment of low-frequency band on/off	Off, On	–
		V3	Freq	Center frequency of low-frequency band (Hz)	31.0 to 420.0 (114.1)	
		V4	Level	Level of low-frequency band	–15 dB to +15 dB (0 dB)	
Limiter/Compressor	Set the limiter or compressor when inputting audio with large level differences. <ul style="list-style-type: none"> The limiter restricts the peak components of an audio signal with large level differences. It also compresses the sound exceeding a certain threshold volume, thus preventing excess outputs. The compressor gently compresses the level of audio at and above the threshold level, thus smoothing out an audio signal with large level differences. 	V3	Type	Selects method for compressing audio	Off, Lim (limiter), Comp (compressor)	–
		V4	Thresh	Level at which the limiter or compressor takes effect (threshold)	0 dB to –60 dB (–20 dB)	
Pan	Adjust the audio left and right balance.	V4	Bal	Adjusts left and right balance	15L to 15R (0)	–

Menu item	Description	Knob	Parameter	Meaning	Setting range	Reference page
PGM Assign	Output the audio from the PGM OUT Connector. Tip The output level of the audio output from the PGM OUT connector can be adjusted with the program fader in the audio control block.	V4	PGM	Turns output of the PGM OUT connector on/off	Off, On	–
MIX OUT Assign	Output the audio from the MIX OUT Connector.	V4	MIX	Turns output of MIX OUT connector on/off	Off, On	–
AUX1 OUT Assign	Output the audio from the AUX OUT 1 connector. About the state of the audio that is output Pre: Outputs the audio prior to level control with the audio channel fader. Post: Outputs the audio in the state in which all of the adjustments except pan have been applied to the audio signal.	V2	AUX1	Turns output of AUX OUT 1 connector on/off	Off, On	–
		V3	Level	Adjusts audio level	–8 to +10 dB (0 dB)	
		V4	Type	State of audio that is output	Pre, Post	
AUX2 OUT Assign	Output the audio from the AUX OUT 2 connector. About the state of the audio that is output Pre: Outputs the audio prior to level control with the audio channel fader. Post: Outputs the audio in the state in which all of the adjustments except pan have been applied to the audio signal.	V2	AUX2	Turns output of AUX OUT 2 connector on/off	Off, On	–
		V3	Level	Adjusts audio level	–8 to +10 dB (0 dB)	
		V4	Type	State of audio that is output	Pre, Post	

Overview

Input freeze is a function that allows you to freeze images from individual input signals.

Frame memory is a function that allows you to freeze images and then write it to the memory of the unit so that you can use it as input material.

Images that are stored in frame memory can be used as the video input signals (FM) of the cross point buttons (PGM buttons and PST/KEY buttons).

Tips

- Frame memory setting can be stored using the snapshot function.
- Input freeze and frame memory are not available in 3D mode (the [Frame Memory] menu is not displayed).

Freezing Input Images

- 1 Press the FM button in the menu control block to display the [Frame Memory] menu, and turn the V1 knob to select [Input Freeze].
- 2 Turn the V3 knob to select the input signal, turn the V4 knob to select [On], and press the V4 knob at the timing you want to freeze.

The input image is frozen.

Tip

If you want to freeze an image again, select [Off], press the V4 knob, and then select [On] again.

Knob	Parameter	Meaning	Setting range
V3	Input	Selects input signal	SDI1, SDI2, SDI3, SDI4, DVI, H/V1, H/V2, H/V3
V4	Freeze	Turns freeze on/off	Off, On

Selecting Frame Memory for Use as Frame Memory Video (FM)

Display the [Frame Memory] menu, turn the V1 knob to select [Select], and turn the V4 knob to select the frame memory to which the image you want to use as the frame memory video is saved.

Frame Memory 1 to 12 are indicated as “FM1,” “FM2,” ... “FM12.”

Knob	Parameter	Meaning	Setting range
V4	FM	Selects the frame memory to be used as frame memory video (FM)	FM1 , FM2, FM3, FM4, FM5, FM6, FM7, FM8, FM9, FM10, FM11, FM12

Saving Images to Frame Memory

Select the frame memory to which to save (Frame Memory 1 to 12), select the input signal to be used as the source, and then freeze the input image to write it to memory.

- 1 Display the [Frame Memory] menu, turn the V1 knob to select [Frame Memory Freeze], and then press the knob.

The [Frame Memory Freeze] menu appears.

- 2 Turn the V1 knob to select the frame memory to which to save the image ([Frame Memory 1] to [Frame Memory 12]), turn V2 and V3 knobs to select the source images, turn the V4 knob to select [On], and press the V4 knob.

Knob	Parameter	Meaning	Setting range
V2	Src V	Selects video source image	Black, SDI1 , SDI2, SDI3, SDI4, DVI, H/V1, H/V2, H/V3, ColBg, PGM, Aux1, Aux2
V3	Src K	Selects key source image	Black , SDI1, SDI2, SDI3, SDI4, DVI, H/V1, H/V2, H/V3, ColBg, PGM, Aux1, Aux2
V4	Store	Saves input image	Off , On

The input image is saved to memory.

Tips

- If the [Store] parameter is set to [Off], the input video of the frame memory is output.
- If [Src K] is set to [Black], an all white signal is assigned to the key source image.

- 3 Press the FM menu selection button to exit the [Frame Memory Freeze] menu.

Note

The frame memory ([Frame Memory 1] to [Frame Memory 12]) selected with the V1 knob in the [Frame Memory Freeze] menu will be automatically selected to the FM of the video input signal, and this will be reflected in the selection status of [Select] in the [Frame Memory] menu.

Importing and Exporting Images

You can use a USB flash drive to import images to the unit as frame memory, and export the frame memory saved in the unit.

Importing Images

File formats supported for import

- TGA
- TIFF
- BMP

Notes

- Enter up to 25 single-byte alphanumeric characters (including the extension) for file names. A file with a name of 26 characters or more will not be displayed. If a file that includes non-alphanumeric characters in its name exists, an error message will appear. In such cases, press the V3 knob to display only files names that include alphanumeric characters exclusively.
- If an image is too large, the protruding portions will be cut. If an image is too small, the missing portions will be filled with black.
- Import operations are not guaranteed for TGA and TIFF files that include layer information.

- 1 Copy the images you want to import to the following folder on a USB flash drive, and then insert the USB flash drive into the USB connector of the unit.

Folder name: \Sony\MCS\FM

- 2 Display the [Frame Memory] menu, turn the V1 knob to select [Import], and press this knob.

The data in the USB flash drive is read and the files that can be imported are displayed.

- 3 Turn the V1 knob to select the first file to import, turn each knob to specify the frame memory and the number of files to import, and press the V4 knob to start importing.

When the V4 knob is pressed, the specified number of files are imported.

Knob	Parameter	Meaning	Setting range
V2	Dest	Selects the first frame memory to import	FM1, FM2, FM3, FM4, FM5, FM6, FM7, FM8, FM9, FM10, FM11, FM12

Knob	Parameter	Meaning	Setting range
V3	Num	Number of files to import	1 to 12

Tips

- If you import TGA files or TIFF files that include alpha channels, a frame memory that includes a key source will be created.
- You can import RLE-compressed TGA files.
- Compressed TIFF files cannot be imported.
- If you import BMP files, or TGA or TIFF files that do not include alpha channels, a frame memory with an all-white key source will be created.
- If a frame memory is registered to the specified frame memory number, it will be overwritten by the imported image.

Deleting frame memory from the USB flash drive

- 1 Perform steps 1 and 2 of the “Importing Images” procedure above to display the files.

- 2 Turn the V1 knob to select the file you want to delete, and then hold down the V1 knob.

The V1 display changes from [Remove] to [OK?].

- 3 Hold down the V1 knob again.

The selected file is deleted.

To cancel the delete operation, turn the V1 knob or press a menu selection button.

Tip

Delete files one at a time. Multiple files cannot be deleted simultaneously.

Export Frame Memory

You can export the frame memory stored in the unit to a USB flash drive.

- 1 Insert the USB flash drive into the USB connector of the unit.

- 2 Display the [Frame Memory] menu and turn the V1 knob to select [Export].

- 3 Turn each knob to select the frame memory to export, and then press the V4 knob to start exporting.

When the V4 knob is pressed, the specified number of frame memory is exported.

Knob	Parameter	Meaning	Setting range
V2	Source	Selects first frame memory to export	FM1 , FM2, FM3, FM4, FM5, FM6, FM7, FM8, FM9, FM10, FM11, FM12
V3	Num	Number of frame memory to export	1 to 12

Tips

- Only BMP format files can be exported. Alpha channels cannot be added.
- The folder to which the files are exported and the file names are as shown below.

Folder name: \Sony\MCS\FM

File name: YYMMDD-HHMMSS-##V.bmp

(# is the frame memory number [01 to 12])

Importing and Exporting Configuration Data

You can export configuration data in which various settings of the unit have been saved to a USB flash drive, and import saved configuration data to the unit.

Tip

Configuration data contains various settings of the unit. When you want to, for example, restore previous settings, you can easily make the settings by importing the configuration data. We recommend that you save the configuration data such as when you change the settings.

Exporting Configuration Data

- 1 Insert the USB flash drive into the USB connector of the unit.
- 2 Press the FILE button in the menu control block to display the [File] menu, turn the V1 knob to select [Export Config], and press the V4 knob to start exporting.

Tip

The folder to which the files are exported is as shown below.

Folder name:
\\Sony\MCS\CONFIG\YYMMDD-HHMMSS

Note

The following settings are not saved under configuration data.

Front panel buttons

- ACCESS/PFL (1 to 6)
- DIM
- MONITOR SEL
- CH ON (1 to 6)
- Bus delegation buttons (BKGD, KEY, AUX 1, AUX 2)
- Menu selection buttons
- Numeric keypad buttons (EFF, SNAPSHOT, DIRECT/ESC)

Menus

Menu	Group	Parameter
Frame Memory	Input Freeze	Input, Freeze
	Select	FM
	Export	Source, Num
Frame Memory > Freeze	All	–
Frame Memory > Import	All	–
Misc	Port Enable	GPI, RS232C
File	All	–
File > Import Config	All	–
File > Import Snapshot	All	–
Setup > System	Startup Mode	All
	Date	All
	Time	All

Miscellaneous

- Frame memory video
- Make sure that the number of files in the folder does not exceed 99. Even if a folder contains 100 files or more, only 99 files will be displayed in the list. To delete a file, select the file you want to delete and hold down the V1 knob.

Importing Configuration Data

1 Insert the USB flash drive that stores the configuration data you want to restore into the USB connector of the unit.

2 Display the [File] menu, turn the V1 knob to select [Import Config], and press this knob.

The data in the USB flash drive is read and the configuration data that can be imported is displayed.

3 Turn the V1 knob to select the configuration data to import, and press the V4 knob to start importing.

When importing is complete, a message prompting you to restart the unit appears.

4 Press the V3 knob (OK), and then turn off the unit and turn it on again.

Tip

When you import configuration data, the startup mode will automatically change to [User].

For details on the startup mode, see “Startup Mode” (page II-49).

Importing and Exporting Snapshots

You can export the snapshots stored in the unit to a USB flash drive, and import the snapshots stored in the USB flash drive to the unit.

Tip

Snapshots cannot be imported or exported in 3D mode.

Exporting Snapshots

1 Insert the USB flash drive into the USB connector of the unit.

2 Display the [File] menu and turn the V1 knob to select [Export Snapshot], turn each knob to specify the files to export, and press the V4 knob to start exporting.

When the V4 knob is pressed, the specified number of snapshots are exported.

Knob	Parameter	Meaning	Setting range
V2	Source	Number of first snapshot to export	SS1 to SS20
V3	Num	Number of snapshots to export	1 to 20

Tip

The folder to which the files are exported and the file names are as shown below.

Folder name: \Sony\MCS\SNAPSHOT

File name: YYMMDD-HHMMSS-##.SSS

(## is the snapshot number [01 to 20])

Note

When exporting snapshots, make sure that the number of files in the folder does not exceed 99. Even if a folder contains 100 files or more, only 99 files will be displayed in the list. To delete a file, select the file you want to delete and hold down the V1 knob.

Importing Snapshots

- 1 Insert the USB flash drive that stores the snapshots you want to import into the USB connector of the unit.
- 2 Display the [File] menu, turn the V1 knob to select [Import Snapshot], and then press the knob.

The data in the USB flash drive is read and the snapshots that can be imported are displayed.

Tip

Snapshot files are displayed in order, starting with the oldest.

- 3 Turn the V1 knob to select the snapshot to import, turn each knob to specify the snapshots to import, and press the V4 knob to start importing.

When the V4 knob is pressed, the specified number of snapshots are imported.

Knob	Parameter	Meaning	Setting range
V2	Dest	Number of first snapshot to import	SS1 to SS20
V3	Num	Number of snapshots to import	1 to 20

Tip

If a snapshot is already stored to the specified snapshot number, it will be overwritten by the imported snapshot.

Deleting snapshots from the USB flash drive

- 1 Perform steps 1 and 2 of the “Importing Snapshots” procedure above to display the snapshots.
- 2 Turn the V1 knob to select the snapshot you want to delete, and then hold down the V1 knob.
The V1 display changes from [Remove] to [OK?].
- 3 Hold down the V1 knob again.

The selected snapshot is deleted.

To cancel the delete operation, turn the V1 knob or press a menu selection button.

Tip

Delete files one at a time. Multiple files cannot be deleted simultaneously.

Formatting a USB Flash Drive

- 1 Insert the USB flash drive into the USB connector of the unit.
- 2 Display the [File] menu, turn the V1 knob to select [USB Memory Format], and press the V4 knob to start formatting.

Tip

The following folders are created when formatting is performed.

Folder name: \Sony\MCS\CONFIG
 \Sony\MCS\FM
 \Sony\MCS\SNAPSHOT

Overview

With this unit, you can create a 3D video signal by inputting a video for the left eye (L) and a video for the right eye (R) as a pair.

This chapter describes the connections and settings required for using the unit in a 3D system.

Flow of connections and settings

When using the unit in a 3D system, make the following necessary connections and settings.

Connecting Each of the Devices (page II-6)



Setting the Signal Format and Video Size (page II-42)



Turning 3D Mode On (page II-42)



Confirming 3D Video Output (page II-43)

The connectors for inputting and outputting 3D video signals are fixed. When configuring a 3D system, see “Example 2: When 3D system” (page II-6) in “System Configuration Examples”.

Note

In 3D mode, menus cannot be assigned to or recalled using the MENU buttons.

Notes and restrictions

The following restrictions apply when configuring a 3D system including the unit.

- Configure the 3D system with only one MCS-8M unit. Two units cannot be used linked together.
- When the unit is operated in a 3D system, only an HD (1080i/59.94, 1080i/50, 720p/59.94, or 720p/50) signal format can be used. If the signal format is changed from HD to SD, 3D mode is canceled.
- Audio embedded in HDMI inputs cannot be used.

- The connectors that can be used for 3D video input and the cross point buttons to which video signals can be assigned are fixed as shown below.

Video Input Connector	Input Signal	Cross Point Button
SDI IN 1	SDI 1 (L)	1
SDI IN 2	SDI 1 (R)	
SDI IN 3	SDI 2 (L)	2
SDI IN 4	SDI 2 (R)	

- The connectors to which 3D video output signals can be assigned are fixed as shown below.

Video Output Connector	Output signal	Remark
SDI OUT PGM	PGM (L)	
SDI OUT AUX 1	PGM (R)	
SDI OUT AUX 2	PGM (L+R)	Side by Side
SDI OUT MULTI VIEWER	Multi Viewer	
DVI-D OUT AUX	PGM (L+R)	Side by Side
DVI-D OUT MULTI VIEWER	Multi Viewer	

- Use a reference signal to synchronize the images from the 3D video input device and this unit.
- The TALLY/GPI connector will be dedicated to TALLY. The TALLY will be fixed at IN1 (SDI IN 1, IN 2) and IN2 (SDI IN 3, IN 4).

Making the Necessary Settings

Make the settings for operating the unit in a 3D system in the [Setup] menu.

Display the [Setup] menu by pressing the SETUP button in the menu control block.

Setting the Signal Format and Video Size

- 1 Display the [Setup] menu, select [System] menu > [System Format], and use the corresponding knobs to make each of the following settings.

Knob	Parameter	Meaning	Setting Value
V3	Format	Signal format	108059 (1080i/59.94), 108050 (1080i/50), 720p59 (720p/59.94), 720p50 (720p/50)
V4	Aspect	Aspect ratio of video	16:9

Tip

The [Aspect] of the video is fixed at 16:9.

For details on the setting, see "Configuring the Signal Format and Aspect Ratio" (→ Basic Operation).

- 2 Press the V3 or V4 knob.

A message prompting you to restart the unit appears.

- 3 Press the V3 knob (OK).

Turning 3D Mode On

- 1 Display the [Setup] menu, select [System] menu > [3D Mode], turn the V4 knob to select [On].

Knob	Parameter	Meaning	Setting Value
V4	3D	Turns 3D mode on/off	Off, On

- 2 Press the V4 knob.

A message prompting you to restart the unit appears.

- 3 Press the V3 knob (OK), and then turn off the unit and turn it on again.

Tips

- In 3D mode, the BKGD bus delegation button will be lit, and the KEY, AUX 1, and AUX 2 buttons will be disabled.
 - Next transition is fixed at BKGD.
 - Transition types will be fixed at MIX.
 - The FTB and KEY TRANS buttons in the transition control block will be disabled.
 - The numeric keypad block will be disabled.
 - In the menu control block, only the MISC, FILE, and SETUP buttons will be enabled.
- In addition, menus will be restricted as follows.

[Misc] menu

Menu item	Restriction
Transition Rate (1/2)	• Only the [Effect] transition rate is enabled.
Transition Rate (2/2)	• Setting is disabled.
Color BKGD	• Setting is disabled.
Port Enable	• [GPI] is fixed at [Disbl] (disable). • Only [RS232C] can be selected.

[Setup] menu

Menu item	Restriction
Video (XPT)	• Movement to the sub-level setting is disabled (assignments for cross-point buttons are fixed).
Video (Output)	• Movement to the sub-level setting is disabled (assignments for video output are fixed).
Multi Viewer	• Only setting of the number of sub-screens is enabled. • Assignment of video to the sub-screens is fixed.
GPI/Tally	• Movement to the sub-level setting is disabled.

[File] menu

Menu item	Restriction
Import Snapshot	<ul style="list-style-type: none">• Movement to the sub-level setting is disabled.
Export Snapshot	<ul style="list-style-type: none">• Exporting is disabled.

- The following data will not be saved by the [Startup Define] operation in the [Setup] menu. These settings will return to default values at each startup.
 - PGM bus cross-point: 1
 - PST bus cross-point: 1
 - Effect transition rate: 30

Confirming 3D Video Output

3D video input is assigned to the cross point buttons (PGM buttons and PST/KEY buttons) 1 and 2.

Press cross point buttons 1 and 2 and confirm that 3D video is output.

Enabling/Disabling Operation from External Devices

Enable or disable the GPI port which is used for operation from external devices.

- 1 Display the [Misc] menu, turn the V1 knob to select [Port Enable], and use the V3 knob to make the setting.

Knob	Parameter	Meaning	Setting range
V3	GPI	Enables/disables GPI port	Enbl (enable), Disbl (disable)

Connecting with External Devices

Set up a connection with an external device in [GPI/Tally] of the [Setup] menu.

Tip

In 3D mode, [GPI/Tally] is not displayed.

For details on the [GPI/Tally] menu items, see “Details on [GPI/Tally] Menu” (page II-45).

For details on the pin assignment of the TALLY/GPI connector, see “TALLY/GPI connector” (→ Basic Operation).

Setting GPI Inputs

Set the operation and trigger type of the GPI input contacts.

Settings menu: [Setup] menu > [GPI/Tally] menu > [GPI Input 1] to [GPI Input 4] (page II-45)

You can select from the following operations.

NotUse: No operation

CT: Cut

AT: Auto Transition

KeyCT: Key Cut

KeyAT: Key Auto Transition

Aux1CT: Aux1 Cut

Aux1AT: Aux1 Auto Transition

Aux2CT: Aux2 Cut

Aux2AT: Aux2 Auto Transition

SS1 to SS20: Snapshot Recall (1 to 20)

You can select from the following trigger types.

NotUse: The input pulse is ignored.

Rise: The trigger is applied at the rising edge of the input pulse.

Fall: The trigger is applied at the falling edge of the input pulse.

Any: The trigger is applied when the input pulse is inverted.

Setting GPI Outputs/Tallies

Set the GPI outputs or tallies.

Settings menu: [Setup] menu > [GPI/Tally] menu > [GPI Output/Tally 1] to [GPI Output/Tally 8] (page II-46)

You can select from the following trigger types.

NotUse: The output is fixed at a high level.

Rise: The trigger causes the output to decrease to a low level, and that status will continue for a certain duration (1 to 2 frames).

Fall: The trigger causes the output to decrease to a high level, and that status will continue for a certain duration (1 to 2 frames).

Any: Every time the trigger is activated, the output's high and low levels change alternately.

If the GPI outputs are used as tallies, the relationship between Tally 1 to 8 and the input signals is as follows.

Tally	Input Signal
1	SDI 1
2	SDI 2
3	SDI 3
4	SDI 4
5	DVI-1
6	HDMI-1/VIDEO 1
7	HDMI-2/VIDEO 2
8	HDMI-3/VIDEO 3

Details on [GPI/Tally] Menu

To display the [GPI/Tally] menu, display the [Setup] menu and press the V1 knob while [GPI/Tally] is selected.

Menu item	Description	Knob	Parameter	Meaning	Setting range	Reference page
GPI Input 1	Set the operation and trigger type of the GPI input 1 contacts.	V3	Action	Contact operation	NotUse, CT, AT , KeyCT, KeyAT, Aux1CT, Aux1AT, Aux2CT, Aux2AT, SS1 to SS20	II-44
		V4	Edge	Trigger type	NotUse , Rise, Fall, Any	
GPI Input 2	Set the operation and trigger type of the GPI input 2 contacts.	V3	Action	Contact operation	NotUse, CT, AT, KeyCT, KeyAT , Aux1CT, Aux1AT, Aux2CT, Aux2AT, SS1 to SS20	II-44
		V4	Edge	Trigger type	NotUse , Rise, Fall, Any	
GPI Input 3	Set the operation and trigger type of the GPI input 3 contacts.	V3	Action	Contact operation	NotUse, CT, AT, KeyCT, KeyAT, Aux1CT, Aux1AT , Aux2CT, Aux2AT, SS1 to SS20	II-44
		V4	Edge	Trigger type	NotUse , Rise, Fall, Any	

Menu item	Description	Knob	Parameter	Meaning	Setting range	Reference page
GPI Input 4	Set the operation and trigger type of the GPI input 4 contacts.	V3	Action	Contact operation	NotUse, CT, AT, KeyCT, KeyAT, Aux1CT, Aux1AT, Aux2CT, Aux2AT , SS1 to SS20	II-44
		V4	Edge	Trigger type	NotUse , Rise, Fall, Any	
GPI Output/ Tally 1	Set GPI Output 1 or Tally 1.	V2	Use	Selects whether to use as tally or GPI output	Tally , GPIOut (GPI output)	II-44
		V3	Action	Operation when used as GPI output	NotUse , CT, AT, KeyCT, KeyAT, Aux1CT, Aux1AT, Aux2CT, Aux2AT	
		V4	Edge	Trigger type when used as GPI output	NotUse , Rise, Fall, Any	
GPI Output/ Tally 2	Set GPI Output 2 or Tally 2.	V2	Use	Selects whether to use as tally or GPI output	Tally , GPIOut (GPI output)	II-44
		V3	Action	Operation when used as GPI output	NotUse , CT, AT, KeyCT, KeyAT, Aux1CT, Aux1AT, Aux2CT, Aux2AT	
		V4	Edge	Trigger type when used as GPI output	NotUse , Rise, Fall, Any	
GPI Output/ Tally 3	Set GPI Output 3 or Tally 3.	V2	Use	Selects whether to use as tally or GPI output	Tally , GPIOut (GPI output)	II-44
		V3	Action	Operation when used as GPI output	NotUse , CT, AT, KeyCT, KeyAT, Aux1CT, Aux1AT, Aux2CT, Aux2AT	
		V4	Edge	Trigger type when used as GPI output	NotUse , Rise, Fall, Any	
GPI Output/ Tally 4	Set GPI Output 4 or Tally 4.	V2	Use	Selects whether to use as tally or GPI output	Tally , GPIOut (GPI output)	II-44
		V3	Action	Operation when used as GPI output	NotUse , CT, AT, KeyCT, KeyAT, Aux1CT, Aux1AT, Aux2CT, Aux2AT	
		V4	Edge	Trigger type when used as GPI output	NotUse , Rise, Fall, Any	

Menu item	Description	Knob	Parameter	Meaning	Setting range	Reference page
GPI Output/ Tally 5	Set GPI Output 5 or Tally 5.	V2	Use	Selects whether to use as tally or GPI output	Tally , GPIOut (GPI output)	II-44
		V3	Action	Operation when used as GPI output	NotUse , CT, AT, KeyCT, KeyAT, Aux1CT, Aux1AT, Aux2CT, Aux2AT	
		V4	Edge	Trigger type when used as GPI output	NotUse , Rise, Fall, Any	
GPI Output/ Tally 6	Set GPI Output 6 or Tally 6.	V2	Use	Selects whether to use as tally or GPI output	Tally , GPIOut (GPI output)	II-44
		V3	Action	Operation when used as GPI output	NotUse , CT, AT, KeyCT, KeyAT, Aux1CT, Aux1AT, Aux2CT, Aux2AT	
		V4	Edge	Trigger type when used as GPI output	NotUse , Rise, Fall, Any	
GPI Output/ Tally 7	Set GPI Output 7 or Tally 7.	V2	Use	Selects whether to use as tally or GPI output	Tally , GPIOut (GPI output)	II-44
		V3	Action	Operation when used as GPI output	NotUse , CT, AT, KeyCT, KeyAT, Aux1CT, Aux1AT, Aux2CT, Aux2AT	
		V4	Edge	Trigger type when used as GPI output	NotUse , Rise, Fall, Any	
GPI Output/ Tally 8	Set GPI Output 8 or Tally 8.	V2	Use	Selects whether to use as tally or GPI output	Tally , GPIOut (GPI output)	II-44
		V3	Action	Operation when used as GPI output	NotUse , CT, AT, KeyCT, KeyAT, Aux1CT, Aux1AT, Aux2CT, Aux2AT	
		V4	Edge	Trigger type when used as GPI output	NotUse , Rise, Fall, Any	
On Air Source	Set the reference signal for the on-air tally. Notes on setting values PGM: Tally output for input signals being output from PGM. Aux1: Tally output for input signals being output from AUX1. Aux2: Tally output for input signals being output from AUX2.	V4	Source	Reference signal for on-air tally	PGM , Aux1, Aux2	—

Overview

Set up the overall system in the [Setup] menu.

The [Setup] menu contains the following items.

Menu item	Description	Reference page
Startup Define	Save the current setup data.	Basic Operation
System	Make system related settings.	II-48
Audio	Make audio related settings.	II-50
Video (Input)	Make video input related settings.	II-52
Video (XPT)	Assign video input signals to cross point buttons.	II-53
Video (Output)	Make video output related settings.	II-54
Video (Misc)	Make other video related settings.	II-55
Multi Viewer	Set up Multi Viewer.	Basic Operation
GPI/Tally	Make GPI and tally control related settings.	II-44
Information	Display various information on the unit.	II-55
Install	Install application software and firmware.	II-55

To display the [Setup] menu

Press the SETUP button in the menu control block.

To select a menu item

Display the [Setup] menu and then turn the V1 knob to select a menu item.

System Setup (System)

Make system related settings in the items of the [Setup] menu > [System] menu.

Supported input reference signals

You can use any of the following signals as the input reference signal for the unit.

	Signal format	Input reference signal	
		HD Tri Sync	SD Black Burst
HD system	1080i/59.94	59.94	59.94
	1080i/50	50	50
	720p/59.94	59.94	59.94
	720p/50	50	50
SD system	480i/59.94	–	59.94
	576i/50	–	50

Details on [System] Menu

Menu item	Description	Knob	Parameter	Meaning	Setting range	Confirmation (press knob)
System Format	Set the format and aspect ratio to be used by the unit. (→ <i>Basic Operation: "Configuring the Signal Format and Aspect Ratio"</i>) Tip If you press the V3 or V4 knob, a message prompting you to restart the unit appears. Press the V3 knob (OK), and then turn off the unit and turn it on again.	V3	Format	Signal format	108059 , 108050, 720p59, 720p50, 480i59, 576i50, Test1, Test2, Test3	Necessary
		V4	Aspect	Aspect ratio	16:9 , 4:3	Necessary
3D Mode	When using a 3D system, turn 3D mode on. (See <i>"Turning 3D Mode On" (page II-42)</i>)	V4	3D	Turns 3D mode on/off	Off , On	Necessary
System Reference	Select the input reference signal. BB (Black Burst) : Black burst signal Tri (Tri Sync) : Tri-level sync for HD system INT (Internal) : Internal reference signal of unit (See <i>"Supported input reference signals" (page II-48)</i>) Tip If you press the V4 knob, a message prompting you to restart the unit appears. Press the V3 knob (OK), and then turn off the unit and turn it on again.	V4	Ref	Input reference signal	BB , Tri, INT	Necessary
REF OUT Phase	Select the output reference signal phase using the output video as a reference. Notes on setting values -1 : One line in advance of output video. 0 : Equal phase as output video. Tip If you press the V4 knob, a message prompting you to restart the unit appears. Press the V3 knob (OK), and then turn off the unit and turn it on again.	V4	Phase	Output reference signal phase	-1 , 0	Necessary
Startup Mode	Select the setup mode (Startup mode) used by the unit at startup. Fact (Factory) : Starts with the factory default settings. User : Starts using the setup data saved in [Setup] menu > [Startup Define]. (→ <i>Basic Operation: "Saving and Selecting Settings"</i>)	V4	Def	Startup mode	Fact , User	Necessary
Date	Set the date for the unit's internal clock. (→ <i>Basic Operation: "Configuring the Date and Time"</i>)	V2	Year	Year	2000 to 2099	Necessary
		V3	Month	Month	1 to 12	Necessary
		V4	Day	Day	1 to 31	Necessary
Time	Set the time for the unit's internal clock. (→ <i>Basic Operation: "Configuring the Date and Time"</i>)	V3	Hour	Hour	0 to 23	Necessary
		V4	Min	Minute	0 to 59	Necessary
LCD Backlight	Adjust the brightness of the backlight of the menu display.	V4	Bright	LCD backlight brightness	Min (minimum), 1, 2, 3, 4, 5, 6, Max (maximum)	Not necessary
Language	Select English or Chinese (Simplified) as the menu display language.	V4	Lang	Language	Eng , Chi	Necessary

Audio Setup (Audio)

Assign audio signal inputs to channel faders and make audio related settings in the items of the [Setup] menu > [Audio] menu.

SDI output embedded audio and audio signal combinations

The following table shows the possible combinations for output.

Embedded Audio	Possible Combinations for Output									
	PGM-L	MIX-L	AUX1	AUX2	AUX1	AUX2	AUX1	AUX2	None	None
SDI 1 to 4 (L)	PGM-L	MIX-L	AUX1	AUX2	AUX1	AUX2	AUX1	AUX2	None	None
SDI 1 to 4 (R)	PGM-R	MIX-R	AUX1	AUX2	AUX2	AUX1	None	None	AUX1	AUX2

Tip

PGM and MIX are handled as a pair.

- When PGM/MIX is assigned to either L or R, the same assignment is made to the other automatically. For example, if L is assigned to “PGM-L,” R is assigned to “PGM-R.”
- If one of L and R is then assigned to other than PGM/MIX, the other is automatically set to “None.”

Details on [Audio] Menu

Menu item	Description	Knob	Parameter	Meaning	Setting range
Audio Input Assign 1 to Audio Input Assign 6	Set the AV Link function. Assign the audio signals input from the audio input connectors to channel faders 1 to 6. (→ <i>Basic Operation: “Assigning Audio Input Signals to the Channel Faders”</i>) Tip In HD mode, SDI 1 to 4 and HDMI 1 to 3 are handled in pairs. • When embedded audio is assigned to either L or R, the same assignment is made to the other automatically. For example, if L is assigned to “SDI1L,” R is assigned to “SDI1R.” • If one of L and R is then assigned to other than the embedded audio of, for example, L8, the other is automatically set to “NotUse.”	V2	AV Link	Turns AV Link on/off	Off, On
		V3	Left	L audio signal	NotUse, M/L1, M/L2, M/L3, M/L4, M/L5, M/L6, L7, L8, SDI1L, SDI2L, SDI3L, SDI4L, HDMI1L, HDMI2L, HDMI3L
		V4	Right	R audio signal	NotUse, M/L1, M/L2, M/L3, M/L4, M/L5, M/L6, L7, L8, SDI1R, SDI2R, SDI3R, SDI4R, HDMI1R, HDMI2R, HDMI3R
MIC/LINE 1 Level to MIC/LINE 6 Level	Adjust the mic/line level for each channel fader. Adjust a level when, for example, the peak indication lights red or when the input signal indication does not light even though an audio signal is being input. (→ <i>Basic Operation: “Assigning Audio Input Signals to the Channel Faders”</i>)	V4	Level	Input level	-44 dB, -20 dB , +4 dB
SDI OUT PGM Assign	Assign the audio signals output from PGM OUT/MIX OUT/AUX OUT 1/AUX OUT 2 connectors to the embedded audio output from the PGM connector of SDI OUT. <i>For details on the possible combinations for output, see page II-50.</i>	V3	Left	Audio signal to assign	None, AUX1, AUX2, PGM-L , MIX-L
		V4	Right	Audio signal to assign	None, AUX1, AUX2, PGM-R , MIX-R

Menu item	Description	Knob	Parameter	Meaning	Setting range
SDI OUT AUX1 Assign	Assign the audio signals output from PGM OUT/MIX OUT/AUX OUT 1/AUX OUT 2 connectors to the embedded audio output from the AUX 1 connector of SDI OUT. <i>For details on the possible combinations for output, see page II-50.</i>	V3	Left	Audio signal to assign	None , AUX1, AUX2, PGM-L, MIX-L
		V4	Right	Audio signal to assign	None , AUX1, AUX2, PGM-R, MIX-R
SDI OUT AUX2 Assign	Assign the audio signals output from PGM OUT/MIX OUT/AUX OUT 1/AUX OUT 2 connectors to the embedded audio output from the AUX 2 connector of SDI OUT. <i>For details on the possible combinations for output, see page II-50.</i>	V3	Left	Audio signal to assign	None , AUX1, AUX2, PGM-L, MIX-L
		V4	Right	Audio signal to assign	None , AUX1, AUX2, PGM-R, MIX-R
SDI OUT MULTI VIEWER Assign	Assign the audio signals output from PGM OUT/MIX OUT/AUX OUT 1/AUX OUT 2 connectors to the embedded audio output from the MULTI VIEWER connector of SDI OUT. <i>For details on the possible combinations for output, see page II-50.</i>	V3	Left	Audio signal to assign	None , AUX1, AUX2, PGM-L, MIX-L
		V4	Right	Audio signal to assign	None , AUX1, AUX2, PGM-R, MIX-R
Audio Output Delay 1	Allows you to delay the audio output from the PGM OUT and MIX OUT connectors on a frame basis. If the output video is delayed with respect to the audio, you can delay the audio to synchronize it with the video. Note Adjusting the delay time may result in noise being generated.	V3	PGM	Delay time for audio output from PGM OUT connector	0.00 to 7.50 (1.00)
		V4	MIX	Delay time for audio output from MIX OUT connector	0.00 to 7.50 (1.00)
Audio Output Delay 2	Allows you to delay the audio output from the AUX OUT 1 and 2 connectors on a frame basis. If the output video is delayed with respect to the audio, you can delay the audio to synchronize it with the video. Note Adjusting the delay time may result in noise being generated.	V3	AUX1	Delay time for audio output from AUX OUT 1 connector	0.00 to 7.50 (1.00)
		V4	AUX2	Delay time for audio output from AUX OUT 2 connector	0.00 to 7.50 (1.00)
Output Level	Adjust the level of audio output to each output destination. Tip The output level of the audio output from the SDI OUT PGM connector can be adjusted with the program fader in the audio control block.	V2	MIX	Output level from MIX OUT connector	$-\infty$ to +10 dB (0 dB)
		V3	AUX1	Output level from AUX OUT 1 connector	$-\infty$ to +10 dB (0 dB)
		V4	AUX2	Output level from AUX OUT 2 connector	$-\infty$ to +10 dB (0 dB)
Oscillator	You can make the settings for outputting the oscillator signal used for adjustment. Tip If other than "Off" is selected for [Freq] when the output destination of the oscillator signal is set in [Term], the DIM button lights and the output level for the headphones or monitor is automatically reduced.	V2	Freq	Frequency of oscillator signal	Off , 100 Hz, 440 Hz, 1 kHz, 10 kHz
		V3	Level	Output level of oscillator signal	$-\infty$ to 0 dB (-20 dB)
		V4	Term	Terminal of oscillator signal	None , PGM , MIX , AUX1 , AUX2 , All (all output destinations)

Video Input Setup (Video (Input))

Make video input related settings in the items of the [Setup] menu > [Video (Input)] menu.

About DVI input signals

- Set the resolution of the DVI signal to be input to one of the following in accordance with the setting of the signal format of the unit (page II-49). Normal images may not be obtained with other resolutions.

	Signal	Resolution	1080i/59.94, 1080i/50	720p/59.94, 720p/50, 480i/59.94, 576i/50
Analog	XGA (60 Hz)	1024 × 768	Yes	Yes
	WXGA (60 Hz)	1280 × 768	Yes	Yes
	SXGA (60 Hz)	1280 × 1024	Yes	Yes
Digital	HDTV (50 Hz)	1920 × 1080	Yes	–
	HDTV (60 Hz)	1920 × 1080	Yes	–

Tip

Although signals with resolutions other than 1920 × 1080 may be accepted when DVI input signals are set to digital, operation is not guaranteed.

- The image size of the DVI input signals will be adjusted to fit the screen of the unit's signal format while maintaining its aspect ratio.

Details on [Video (Input)] Menu

Menu item	Description	Knob	Parameter	Meaning	Setting range
SDI1 to SDI4	Set the SDI signals to input via the SDI IN 1 to 4 connectors.	V3	FS	Frame synchronizer	Off, On
		V4	Name	Input source name	IN1 to IN8, CAM1 to 8, VTR1 to 8, PC1 to 8, SDI1 to 4 , DVI, HDMI1 to 3, VIDEO1 to 3
DVI	Set the format and input source name of the signal to input via the DVI-I IN connector. When you change the signal format, press the V3 knob to confirm the change. <ul style="list-style-type: none"> For details on the DVI signal to be input, see "About DVI input signals" (page II-52). For details on the formats of DVI-I input video signals, also see "Configuring the Format of the Signal Input to the DVI-I Connector" (→ Basic Operation). 	V3	Format	Format of DVI-I input video signal	XGA , SXGA, WXGA, HDTV50, HDTV60
		V4	Name	Input source name	IN1 to IN8, CAM1 to 8, VTR1 to 8, PC1 to 8, SDI1 to 4, DVI , HDMI1 to 3, VIDEO1 to 3
HDMI1 to HDMI3	Set the input source names of the HDMI input signals to be input via the HDMI IN 1 to 3 connectors.	V4	Name	Input source name	IN1 to IN8, CAM1 to 8, VTR1 to 8, PC1 to 8, SDI1 to 4, HDMI1 to 3 , VIDEO1 to 3
VIDEO1 to VIDEO3	Set the pedestal levels and input source names of the video input signals to be input via the VIDEO IN 1 to 3 connectors. When you change a pedestal level, confirm the modification by pressing the V3 knob.	V3	Setup	Pedestal level	0IRE , 7.5IRE
		V4	Name	Input source name	IN1 to IN8, CAM1 to 8, VTR1 to 8, PC1 to 8, SDI1 to 4, DVI, HDMI1 to 3, VIDEO1 to 3

Assigning Video Input Signals to the Cross Point Buttons (Video (XPT))

Assign video signals to the cross point buttons (PGM buttons and PST/KEY buttons) in the items of the [Setup] menu > [Video (XPT)] menu.

For details on the setting procedure, see "Assigning Video Signals to the Cross-Point Buttons" (→ Basic Operation).

Tip

In 3D mode, this menu is not displayed.

Using the Shift Button Function

By using the cross point button 8/SHIFT as the Shift button, you can assign a total of 14 materials (seven to cross buttons 1 to 7, and seven to cross buttons 1 to 7 + Shift button (cross point button 8/SHIFT)).

Settings menu: [XPT Shift Mode] (page II-53)

Numbers are assigned to the cross buttons as shown below in accordance with whether or not the Shift button function is on or off.

Shift button function: Off (non-shift mode)

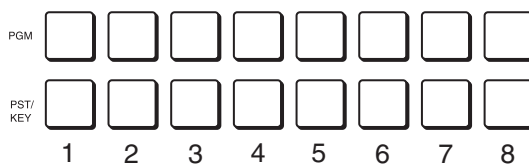

Shift button function: On (shift mode)

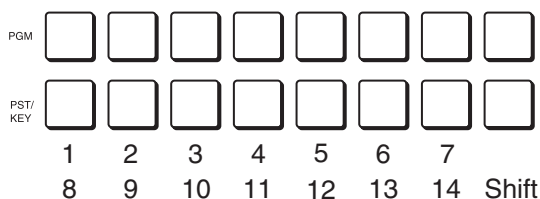

The following table shows the factory default settings for assignments.

PGM/PST Cross Point Button	Initial Value
1 to 4	SDI IN 1 to 4 (SDI1 to SDI4)
5	DVI-I (DVI)
6 to 8	HDMI IN 1 to 3 (H/V1 to H/V3) in HD mode VIDEO IN 1 to 3 (H/V1 to H/V3) in SD mode
9	Color background (ColBg)
10	Frame memory (FM)
11	Program output (PGM)
12 to 14	Black signal (Black)

Details on [Video (XPT)] Menu

Menu item	Description	Knob	Parameter	Meaning	Setting range
XPT Assign 1 to XPT Assign 14	Assign the video signals input from the video input connectors and internally generated signals to cross point buttons 1 to 14 (PGM buttons, PST/KEY buttons).	V4	Source	Video signals	Black, SDI1 to 4, DVI, H/V1 to 3, ColBg, FM, PGM
XPT Shift Mode	Select whether to use cross point button 8 as a Shift button. Hold: The button operates as a shift button, and the cross point buttons on the shift side are enabled while the button is pressed. Lock: The button operates as a shift button, and each press switches between the assignments on the shift side and non-shift side. Off: The button operates as cross point button 8.	V4	Mode	Switches between shift and non-shift	Off , Hold, Lock

Video Output Setup (Video (Output))

Set the video output signal to assign to each video output connector in the items of the [Setup] menu > [Video (Output)] menu.

Tip

In 3D mode, this menu is not displayed.

Details on [Video (Output)] Menu

Menu item	Description	Knob	Parameter	Meaning	Setting range
SDI OUT PGM Assign	Select the signal to assign to the SDI OUT PGM connector. Notes on setting values PGM: Program PVW: Preview Aux1PG: Aux1 program Aux1PV: Aux1 preview Aux2PG: Aux2 program Aux2PV: Aux2 preview MV: Multi Viewer	V4	Output	Output video signal	PGM , PVW, Aux1PG, Aux1PV, Aux2PG, Aux2PV, MV
SDI OUT AUX1 Assign	Select the signal to assign to the SDI OUT AUX 1 connector.	V4	Output	Output video signal	PGM, PVW, Aux1PG , Aux1PV, Aux2PG, Aux2PV, MV
SDI OUT AUX2 Assign	Select the signal to assign to the SDI OUT AUX 2 connector.	V4	Output	Output video signal	PGM, PVW, Aux1PG, Aux1PV, Aux2PG , Aux2PV, MV
SDI OUT MULTI VIEWER Assign	Select the signal to assign to the SDI OUT MULTI VIEWER connector.	V4	Output	Output video signal	PGM, PVW, Aux1PG, Aux1PV, Aux2PG, Aux2PV, MV
DVI OUT AUX Assign	Select the signal to assign to the DVI-D OUT connector in HD mode, and to the VIDEO OUT AUX connector in SD mode.	V4	Output	Output video signal	PGM, PVW, Aux1PG , Aux1PV, Aux2PG, Aux2PV, MV
DVI OUT MULTI VIEWER Assign	Select the signal to assign to the DVI-D OUT MULTI VIEWER connector.	V4	Output	Output video signal	PGM, PVW, Aux1PG, Aux1PV, Aux2PG, Aux2PV, MV
VIDEO	Set the pedestal level of the video output signal that is output via the VIDEO OUT AUX connector. When you change a pedestal level, confirm the modification by pressing the V4 knob.	V4	Setup	Sets pedestal level of VIDEO OUT AUX connector	0IRE , 7.5IRE

Setup of Other Video Related Items (Video (Misc))

Make other settings related to videos in the items of the [Setup] menu > [Video (Misc)] menu.

Details on [Video (Misc)] Menu

Menu item	Description	Knob	Parameter	Meaning	Setting range
Switch Timing	Set the timing for switching videos. Tip If the signal format is set to 720p, this selection is ignored.	V4	Timing	Switching timing	Any (fastest field that can be processed), Field1 (first field), Field2 (second field)
Fade To Black	Enable or disable the FTB button of the transition control block.	V4	Button	Enables/disables FTB button	Enbl (enable)/Disbl (disable)

Displaying Various Information (Information)

You can confirm various information on the application software and the firmware in the items of [Setup] menu > [Information].

Installing Application Software and Firmware (Install)

Install application software and firmware onto the unit from [Setup] menu > [Install].

Tip

It is not possible to individually select which software to install. All of the application software and firmware are installed together at one time.

- 1 Copy the software to be installed to the USB flash drive and then insert the USB flash drive into the USB connector of the unit.

Tip

Copy the software to be installed to the following folder.

Folder name: \Sony\MCS\INSTALL

- 2 Display the [Setup] menu > [Install] menu and then press the V4 knob to start the installation.

When installation is complete, a message prompting you to restart the unit appears. Confirm that no errors have occurred (i.e., “E” is not displayed).

Tip

For details on the message that appears at installation completion, see “*Message List*” (page II-56).

- 3 Press the V3 knob (OK), and then turn off the unit and turn it on again.
- 4 Check the version information of the application software and firmware under [Information] in the [Setup] menu.

Note

If you turn off the unit before application software update is complete normally, the unit may not start properly. In such cases, contact your local Sony representative.

Appendix

Message List

When a problem occurs on the unit during operation, the following types of messages appear. Before contacting your local Sony representative, view the following lists and check the possible solutions. If the problem persists, write down the message number that appears and contact your local Sony representative.

Message example:

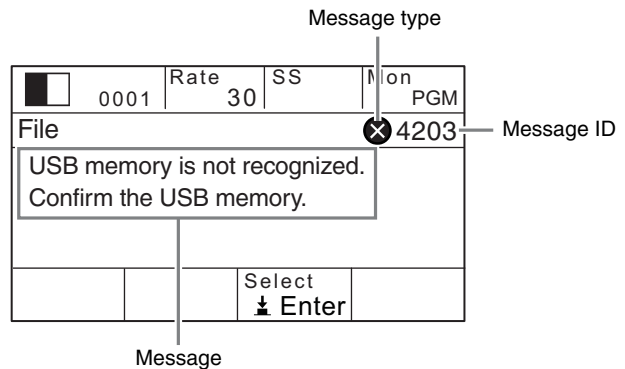

The following message types exist.

- ✘ (Error): Indicates an inability to continue operation, malfunction, or other severe error.
- ⚠ (Warning): Indicates that problems may occur if you continue operation.
- ℹ (Information): Indicates a notification.

Errors

ID	Message	Solution
4001	An internal fan is stopped. Please turn off the system immediately.	The fan has stopped. Turn off the unit immediately, and contact your local Sony representative.
4002	The temperature in the system is rising. Please turn off the system immediately.	The internal temperature of the system is high. Turn off the unit immediately, and contact your local Sony representative.
4003	Unable to start. Please restart.	Try restarting the unit. If it does not restart, contact your local Sony representative.
4004	Unable to start. Please restart.	Try restarting the unit. If it does not restart, contact your local Sony representative.
4005	Unable to start. Please restart.	Try restarting the unit. If it does not restart, contact your local Sony representative.
4201	Loading configuration file error.	The selected configuration file may not be an MCS-8M supported file, or it may be damaged.
4202	Saving configuration file error. Please retry.	The configuration file could not be saved. The USB flash drive may be malfunctioning or may not be supported.

ID	Message	Solution
4203	USB memory is not recognized. Confirm the USB memory.	Check whether operation has been verified with the respective USB flash drive model. If operation has been verified, the USB flash drive may be damaged.
4204	Formatting USB memory error. Please retry.	
4205	Reading folder/file error. Confirm the folder/file.	
4206	Making folder/file error. Please retry.	
4207	Importing error. Please retry.	
4208	Exporting error. Please retry.	
4209	More than 99 files exist in the folder.	Use a computer or other device to delete unnecessary files from the folder so that the number of files does not exceed 99.
4210	No file in the folder. Confirm the folder.	Files do not exist in the folder on the USB flash drive used as the import source. Check the folder on the USB flash drive. <i>For details on folder configurations, see "Formatting a USB Flash Drive" (page II-40).</i>
4211	No data to export. Confirm the source.	The data specified for export does not exist on the unit. Check that the frame memory, snapshot, or other data specified for export has been created.
4212	Importing error. Unsupported format.	Check the requirements for TGA, TIFF, and BMP files that can be imported. <i>(See page II-36)</i>
4213	Folder/File name error. The name can use only an alphanumeric character.	Check that only alphanumeric characters are used in folder and file names.

Warnings

ID	Message	Solution
3001	No reference signal input. Please confirm the reference cable properly configured.	Reference signal input does not exist, although the input reference signal is set to [BB] or [Tri]. Set [System Reference] to [INT], or connect the appropriate reference signal. <i>(See page II-49)</i>
3002	Reference signal unlocked. Please confirm the reference cable properly connected.	The frequency of the reference signal input does not match that of the system format, or it is not locked. Check the reference signal input. <i>("Details on [System] Menu" (page II-49))</i>
3003	The signal format of HDMI IN 1 differs from the system format.	The input signal format of the HDMI IN 1 connector does not match that of the system format. Match the signal to the system format.
3004	The signal format of HDMI IN 2 differs from the system format.	The input signal format of the HDMI IN 2 connector does not match that of the system format. Match the signal to the system format.
3005	The signal format of HDMI IN 3 differs from the system format.	The input signal format of the HDMI IN 3 connector does not match that of the system format. Match the signal to the system format.

Information

ID	Message	Solution
1101	The setting is changed. Perform "Startup Define", and then restart.	This appears when you change the system format or 3D mode, or when the system otherwise needs to be restarted. Execute [Startup Define], and restart the unit.
1102	Finished. Please restart. M: xx/B: xx/F: xx/R: xx/Font: xx FPGA1: xx/2: xx/3: xx/4: xx M: Main B: Boot F: Firmware R: Register Font: Font xx: <ul style="list-style-type: none">• "O": OK• "E": Error• "-": Not installed	This appears to display the results after installation of application software and firmware is complete. If "E" (error) appears, try installing again. If the problem persists, contact your local Sony representative.
1103	Import Finished. Please restart.	This appears when import of a configuration file is complete. Restart the unit.



Index

Numerics

3D Mode II-42, II-49
3D System II-41
8/SHIFT I-12

A

ACCESS/PFL Button I-10, I-38, II-31
Adjustment Knobs 1 to 4 I-11
Adjustment knobs 1 to 4
 Incremental Adjustment I-12
Aspect II-17, II-26, II-30
Aspect Ratio I-19
Audio I-23, I-37
 Mixing I-37
 Monitoring I-37
Audio Channel Menu II-31
 AUX OUT Assign II-33
 Equalizer High II-32
 Equalizer Low II-32
 Equalizer Mid II-32
 Filter II-31
 Input Trim II-31
 Limiter/Compressor II-32
 MIX OUT Assign II-33
 Pan II-32
 PGM Assign II-33
Audio Control Block I-10
Audio Input Assign I-23, II-50
Audio Input Block I-15
Audio Input Signals I-23
Audio Inputs I-25
Audio Level Meters I-10, I-37
Audio Menu II-50
 Audio Input Assign II-50
 Audio Output Delay II-51
 MIC/LINE Level II-50
 Oscillator II-51
 Output Level II-51
 SDI OUT AUX Assign II-51
 SDI OUT MULTI VIEWER
 Assign II-51
 SDI OUT PGM Assign II-50
Audio Mixing II-31
Audio Monitor I-11
Audio Output Block I-15
Audio Output Delay II-51
Auto Adjust Execute I-36, II-27
Auto Chromakey Menu II-27
 Auto Adjust Execute II-27
 Sample Mark II-27
 Sample Mark Adjust II-27
AUTO TRANS Button I-13, I-30, II-8

AUX 1 Buttons I-12
AUX 2 Buttons I-12
AUX OUT Assign II-33
AV Link I-24

B

BKGD Button I-12, I-13, I-39
Border Adjust II-25
Border Matte Adjust II-25
Bus Delegation II-9
Bus Delegation Button
 I-12, I-33, I-39, II-19
 AUX 1 Buttons I-12
 AUX 2 Buttons I-12
 BKGD Button I-12, I-39
 KEY Button I-12, I-33, I-39,
 II-19, II-20

C

CH ON Button I-10, I-37
Channel Fader I-10, I-23, I-37, II-31
Chr I-35
Chr Key Adjust II-28
Chr Key Window II-28
Chr Key Window Adj II-28
Chroma Key I-32, I-34
 Detailed Adjustments II-21
Chromakey Auto Adj I-35, II-24
Chromakey Manual Adj II-24
Color BKGD II-8
Color Cancel II-28
Color Cancel Adjust II-28
Compressor II-32
Configuration Data II-38
Crop H II-18
Crop V II-18
Cropping II-13
Cross-Point Button I-21, I-29
 Assigning Video Signals I-21
 Switching I-29
Cross-Point Control Block I-12
CUT Button I-13, I-29

D

Date I-20
Date and Time I-20
Defocus I-41
Digital Multi Effect II-8, II-20
DIM Button I-10, I-38
Dimmer I-38
Direct Selection I-31
DIRECT/ESC Button I-13, I-32
DME II-8, II-20
DME Wipe II-12
 Basic Operations II-12
 Detailed Adjustments II-13

DME Wipe Adjust II-15
DME Wipe Bkgd Color II-16
DME Wipe Edge II-16
DME Wipe Edge Color II-16
DME Wipe Modify Menu II-18
 Crop H II-18
 Crop V II-18
 Positioner II-18
 Positioner Adjust II-18
 Size II-18
Door I-41
DVI I-22, II-52
DVI Input Signals II-52
DVI OUT AUX Assign II-54
DVI OUT MULTI VIEWER
 Assign II-54
DVI Video Inputs I-22

E

EFF Button I-11, I-13, I-32, I-33, I-34,
 II-10, II-15, II-19
Effect I-30
Effect Menu II-15
 DME Wipe Adjust II-15
 DME Wipe Bkgd Color II-16
 DME Wipe Edge II-16
 DME Wipe Edge Color II-16
 Effect Transition II-15
 Wipe Adjust II-15
 Wipe Edge II-15
 Wipe Edge Color II-15
Effect Pattern List I-41
Effect Transition II-15
Effects I-30
ENTER Button I-13, I-32, I-39
Equalizer II-32
Equalizer High II-32
Equalizer Low II-32
Equalizer Mid II-32
Export II-36
Export Config II-38
Export Snapshot II-39
Exporting II-36, II-38, II-39
 Configuration Data II-38
 Frame Memory II-36
 Snapshot II-39

F

F1 Buttons I-11
F2 button I-11
Fade To Black II-55
Fader Lever I-13, I-30
FILE Button I-11, II-38
File Menu II-38, II-39, II-40
 Export Config II-38
 Export Snapshot II-39

- Import Config II-39
- Import Snapshot II-40
- USB Memory Format II-40
- Fine Key II-25
- Fine Key Adjust H II-25
- Fine Key Adjust V II-25
- Flip Tumble I-41
- FM Button I-11, II-34
- Formatting USB Flash Drive II-40
- Frame In/Out I-30, I-41
- Frame Memory II-34
- Frame Memory Freeze II-35
- Frame Memory Menu
 - II-34, II-35, II-36
 - Export II-36
 - Frame Memory Freeze II-35
 - Import II-36
 - Input Freeze II-34
 - Select II-35
- Freezing II-34
- Front Panel I-10
- FTB Button I-13, II-8, II-55

G

- GPI Input I-46, II-44, II-45
- GPI Output I-46, II-44
- GPI Output/Tally II-46
- GPI/Tally Menu II-45
 - GPI Input II-45
 - GPI Output/Tally II-46
 - On Air Source II-47

H

- HDMI II-52

I

- Import II-36
- Import Config II-39
- Import Snapshot II-40
- Importing II-36, II-39, II-40
 - Configuration Data II-39
 - Image II-36
 - Snapshot II-40
- Information II-55
- Input Freeze II-34
- Input Reference Signals II-48
- Input Signal Indicator I-10, I-25
- Input Trim II-31

K

- Key I-32, II-19
 - Basic Operations II-19
 - Detailed Adjustments II-20
- KEY Button I-11, I-12, I-13, I-33, I-39, II-19, II-20, II-23

- Key DME Wipe II-24
- Key DME Wipe Modify Menu II-30
 - Positioner II-30
 - Positioner Adjust II-30
 - Size II-30
- Key Edge Type II-25
- Key Fill Mat Adjust II-23
- Key Fill/Src Select II-23
- Key Invert II-24
- Key Mask II-25
- Key Mask Box H II-25
- Key Mask Box V II-25
- Key Menu II-23
 - Border Adjust II-25
 - Border Matte Adjust II-25
 - Chromakey Auto Adj II-24
 - Chromakey Manual Adj II-24
 - Fine Key II-25
 - Fine Key Adjust H II-25
 - Fine Key Adjust V II-25
 - Key DME Wipe II-24
 - Key Edge Type II-25
 - Key Fill Mat Adjust II-23
 - Key Fill/Src Select II-23
 - Key Invert II-24
 - Key Mask II-25
 - Key Mask Box H II-25
 - Key Mask Box V II-25
 - Key Soft Edge II-25
 - Key Transition II-23
 - Key Type Select II-23
 - Key Wipe II-24
 - Key Wipe Edge II-24
 - Lin Key Adjust II-23
 - Lin Key Mode II-24
 - Lum Key Adjust II-23
 - Lum Key Mode II-23
 - Resizer II-23
- Key Soft Edge II-25
- KEY TRANS Button
 - I-13, II-8, II-20, II-23
- Key Transition II-20
- Key Type II-21
- Key Type Select I-33, I-35, II-23
- Key Wipe II-24
- Key Wipe Edge II-24
- Key Wipe Modify Menu II-29
 - Aspect II-30
 - Multi II-30
 - Multi Adjust II-30
 - Positioner II-29
 - Positioner Adjust II-29
 - Rotation II-29
 - Rotation Adjust II-29

L

- LCD Backlight II-49

- Limiter II-32
- Limiter/Compressor II-32
- Lin Key Adjust II-23
- Lin Key Mode II-24
- Linear Key I-32, II-21
- Location II-26
- Lum I-33
- Lum Key Adjust II-23
- Lum Key Mode II-23
- Luminance Key I-32, I-33, II-21

M

- Manual Chromakey Menu II-28
 - Chr Key Adjust II-28
 - Chr Key Window II-28
 - Chr Key Window Adj II-28
 - Color Cancel II-28
 - Color Cancel Adjust II-28
- Menu
 - Operations I-12
 - Viewing I-11
- Menu Control Block I-11
- Menu Selection Button I-11
 - EFF Button I-11, II-15
 - FILE Button I-11, II-38
 - FM Button I-11, II-34
 - KEY Button I-11, II-23
 - MENU1 and 2 Buttons I-11
 - MISC Button I-11, II-8
 - SETUP Button I-11, I-19, I-20, I-21, I-22, II-48
- MENU1 and 2 Buttons I-11
- Message List II-56
- MIC/LINE Level I-25, II-50
- MISC Button I-11, II-8
- Misc Menu II-8
 - Color BKGD II-8
 - Port Enable II-8
 - Transition Rate II-8
- Mix I-30, I-31, I-41, II-20
- MIX Button
 - I-13, I-31, I-33, I-34, II-19
- MIX OUT Assign II-33
- MONITOR LEVEL Adjustment
 - Knob I-10, I-38
- MONITOR SEL Button I-10, I-37
- Mosaic I-41
- Multi II-17, II-30
- Multi Adjust II-17, II-30
- Multi Viewer I-27

N

- NAM I-41, II-8
- Next Transition Selection Button I-13
 - BKGD Button I-13
 - KEY Button I-13

Non-Additive Mix II-8
Numeric Buttons (0 to 9) I-13, I-31
Numeric Keypad I-31
Numeric Keypad Block I-13

O

On Air Source II-47
Oscillator II-51
Output Level II-51

P

Pan II-32
Peak Indicator I-10, I-25
PFL I-38
PGM Assign II-33
PGM Cross-Point Button
I-12, I-21, I-29
Pin Configurations I-46
PinP I-41, II-13
Port Enable II-8
POS Button I-11, II-11, II-13
Positioner II-16, II-18, II-29
Positioner Adjust
II-16, II-18, II-29, II-30
Pre-Fade Listen I-37
Preview Video I-27
Program Fader I-10, I-37
Program Video I-27
PST/KEY Cross-Point Button
I-12, I-21, I-29

R

REF OUT Phase II-49
Reference Signal Input/Output
Block I-16
Resizer II-23
Resizer Menu II-26
Aspect II-26
Location II-26
Rotation II-27
Rotation Mode II-26
Rotation II-17, II-29
Rotation Adjust II-17, II-29
Rotation Mode II-26

S

Sample Mark I-35, II-27
Sample Mark Adjust I-35, II-27
Saving Settings I-40
SDI II-52
SDI OUT AUX Assign II-51, II-54
SDI OUT MULTI VIEWER
Assign II-51, II-54
SDI OUT PGM Assign II-50, II-54
Select II-35

Setup II-48
SETUP Button
I-11, I-19, I-20, I-21, I-22, II-48
Setup Menu
II-45, II-48, II-50, II-52, II-53,
II-54, II-55
Audio II-50
GPI/Tally II-45
Information II-55
Install II-55
Multi Viewer I-27
Startup Define I-40
System II-48
Video (Input) II-52
Video (Misc) II-55
Video (Output) II-54
Video (XPT) II-53
SHIFT II-53
Signal Assign I-27
Signal Format I-19
Size II-18
Slide I-41
Snapshot I-38, II-39
Recalling I-39
Saving I-38
SNAPSHOT Button I-13, I-38
Specifications I-43
Squeeze I-41
Startup Define I-40
Startup Mode II-49
STORE Button I-13, I-39
System Configuration Example
3D System II-6
HD System I-9
SD System II-5
System Format I-19, II-49
System Menu II-49
3D Mode II-49
Date II-49
LCD Backlight II-49
REF OUT Phase II-49
Startup Mode II-49
System Format II-49
System Reference II-49
Time II-49
System Reference II-49

T

Tally Input I-46
Tally Output II-44
Time I-20
Transition Control Block I-13
Transition Indicator I-13, I-31
Transition Rate I-31, II-8
Transition Rate Area I-11
Transition Type II-8

Transition Type Selection Button
I-13
EFF Button
I-13, I-33, I-34, II-10, II-19
MIX Button
I-13, I-31, I-33, I-34, II-19
Troubleshooting I-42
Turning the Unit On/Off I-18

U

USB Memory Format II-40

V

V1 I-12
V2 I-12
V3 I-12
V4 I-12
VIDEO II-52
Video (Input) I-22
Video (Input) Menu II-52
DVI II-52
HDMI II-52
SDI II-52
VIDEO II-52
Video (Misc) Menu II-55
Fade To Black II-55
Switch Timing II-55
Video (Output) Menu II-54
DVI OUT AUX Assign II-54
DVI OUT MULTI VIEWER
Assign II-54
SDI OUT AUX Assign II-54
SDI OUT MULTI VIEWER
Assign II-54
SDI OUT PGM Assign II-54
VIDEO II-54
Video (XPT) I-21
Video (XPT) Menu II-53
XPT Assign II-53
XPT Shift Mode II-53
Video Input Block I-16
Video Output Block I-16
Video Switching I-29, II-7
Viewer Mode I-27

W

Wipe I-30, I-41, II-8, II-10, II-20
Wipe Adjust II-15
Wipe Edge II-12, II-15
Wipe Edge Color II-15
Wipe Modify Menu II-16
Aspect II-17
Multi II-17
Multi Adjust II-17
Positioner II-16
Positioner Adjust II-16

Rotation II-17
Rotation Adjust II-17
Wipe Patterns II-10

X

XPT Assign I-21, II-53
XPT Shift Mode II-53
X-Y Pointer I-11, II-11, II-13

The material contained in this manual consists of information that is the property of Sony Corporation and is intended solely for use by the purchasers of the equipment described in this manual.

Sony Corporation expressly prohibits the duplication of any portion of this manual or the use thereof for any purpose other than the operation or maintenance of the equipment described in this manual without the express written permission of Sony Corporation.

Trademarks

HDMI, the HDMI logo, and High-Definition Multimedia Interface are registered trademarks or trademarks of HDMI Licensing LLC.

Other products or system names appearing in this document are trademarks or registered trademarks of their respective owners.

Further, the ® or ™ symbols are not used in the text.

<http://www.sony.net/>

Sony Corporation