

datavideo

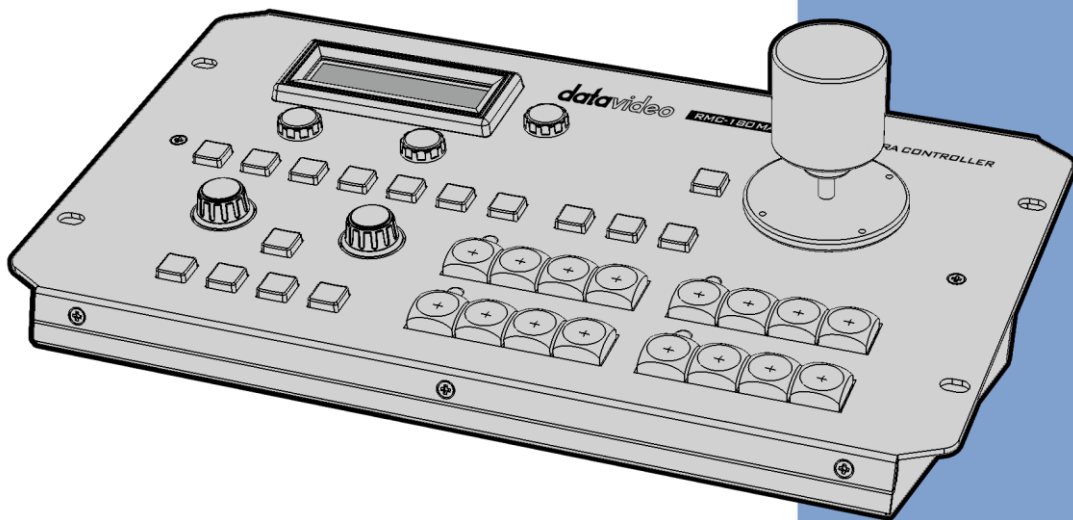

PTZ CAMERA CONTROLLER
RMC-180 MARK II
Instruction Manual

www.datavideo.com

Table of Contents

FCC COMPLIANCE STATEMENT	4
WARNINGS AND PRECAUTIONS	4
WARRANTY	5
STANDARD WARRANTY.....	5
THREE YEAR WARRANTY.....	5
DISPOSAL	6
1. INTRODUCTION	7
1.1 FEATURES	7
1.2 COMPATIBLE CAMERA MODELS	7
1.3 COMPATIBLE CAMERA CONTROL PROTOCOL	7
1.4 SYSTEM DIAGRAMS	8
<i>PTC-280</i>	8
<i>PTR-10</i>	8
2. CONNECTIONS AND CONTROLS	9
2.1 FRONT PANEL – KEYBOARD	9
2.2 REAR PANEL – CONNECTIONS	14
3. MENU SETUP	17
FN1. EXIT	18
FN2. CAM ADDRESS.....	18
FN3. JOYSTICK DIR	18
FN4. VIDEO FORMAT	19
FN5. POWER.....	19
FN6. SCREEN MODE	19
FN7. MEMORY SPEED.....	19
FN8. TALLY LED MODE	19
FN9. R/B GAIN ADJ	20
FN10. SHUTTER ADJ.....	20
FN11. FIRMWARE VER.....	20
FN12. CAM INFO.....	20
FN13. BACKLIGHT ADJ	20
FN14. ADVANCED MODE	21
4. STORING DIFFERENT CAMERA POSITIONS	22
5. RS-422 PINOUT	23
DIRECT CONNECTION TO CAMERA	23
CONNECTION TO CAMERA VIA HBT-11	23
6. TALLY PORT	25
7. FIRMWARE UPGRADE PROCEDURE	26
FIRMWARE	26
BOOTLOADER AND FIRMWARE	26
8. DIMENSIONS	30

9. SPECIFICATIONS..... 31

SERVICE AND SUPPORT 32

Disclaimer of Product and Services

The information offered in this instruction manual is intended as a guide only. At all times, Datavideo Technologies will try to give correct, complete and suitable information. However, Datavideo Technologies cannot exclude that some information in this manual, from time to time, may not be correct or may be incomplete. This manual may contain typing errors, omissions or incorrect information. Datavideo Technologies always recommend that you double check the information in this document for accuracy before making any purchase decision or using the product. Datavideo Technologies is not responsible for any omissions or errors, or for any subsequent loss or damage caused by using the information contained within this manual. Further advice on the content of this manual or on the product can be obtained by contacting your local Datavideo Office or dealer.

FCC Compliance Statement

This device complies with part 15 of the FCC rules. Operation is subject to the following two conditions:

1. This device may not cause harmful interference, and
2. This device must accept any interference received, including interference that may cause undesired operation.

Warnings and Precautions



1. Read all of these warnings and save them for later reference.
2. Follow all warnings and instructions marked on this unit.
3. Unplug this unit from the wall outlet before cleaning. Do not use liquid or aerosol cleaners. Use a damp cloth for cleaning.
4. Do not use this unit in or near water.
5. Do not place this unit on an unstable cart, stand, or table. The unit may fall, causing serious damage.
6. Slots and openings on the cabinet top, back, and bottom are provided for ventilation. To ensure safe and reliable operation of this unit, and to protect it from overheating, do not block or cover these openings. Do not place this unit on a bed, sofa, rug, or similar surface, as the ventilation openings on the bottom of the cabinet will be blocked. This unit should never be placed near or over a heat register or radiator. This unit should not be placed in a built-in installation unless proper ventilation is provided.
7. This product should only be operated from the type of power source indicated on the marking label of the AC adapter. If you are not sure of the type of power available, consult your Datavideo dealer or your local power company.
8. Do not allow anything to rest on the power cord. Do not locate this unit where the power cord will be walked on, rolled over, or otherwise stressed.
9. If an extension cord must be used with this unit, make sure that the total of the ampere ratings on the products plugged into the extension cord do not exceed the extension cord rating.
10. Make sure that the total amperes of all the units that are plugged into a single wall outlet do not exceed 15 amperes.
11. Never push objects of any kind into this unit through the cabinet ventilation slots, as they may touch dangerous voltage points or short out parts that could result in risk of fire or electric shock. Never spill liquid of any kind onto or into this unit.
12. Except as specifically explained elsewhere in this manual, do not attempt to service this product yourself. Opening or removing covers that are marked "Do Not Remove" may expose you to dangerous voltage points or other risks, and will void your warranty. Refer all service issues to qualified service personnel.
13. Unplug this product from the wall outlet and refer to qualified service personnel under the following conditions:
 - a. When the power cord is damaged or frayed;
 - b. When liquid has spilled into the unit;

- c. When the product has been exposed to rain or water;
- d. When the product does not operate normally under normal operating conditions. Adjust only those controls that are covered by the operating instructions in this manual; improper adjustment of other controls may result in damage to the unit and may often require extensive work by a qualified technician to restore the unit to normal operation;
- e. When the product has been dropped or the cabinet has been damaged;
- f. When the product exhibits a distinct change in performance, indicating a need for service.

Warranty

Standard Warranty

- Datavideo equipment are guaranteed against any manufacturing defects for one year from the date of purchase.
- The original purchase invoice or other documentary evidence should be supplied at the time of any request for repair under warranty.
- The product warranty period begins on the purchase date. If the purchase date is unknown, the product warranty period begins on the thirtieth day after shipment from a Datavideo office.
- All non-Datavideo manufactured products (product without Datavideo logo) have only one year warranty from the date of purchase.
- Damage caused by accident, misuse, unauthorized repairs, sand, grit or water is not covered under warranty.
- Viruses and malware infections on the computer systems are not covered under warranty.
- Any errors that are caused by unauthorized third-party software installations, which are not required by our computer systems, are not covered under warranty.
- All mail or transportation costs including insurance are at the expense of the owner.
- All other claims of any nature are not covered.
- All accessories including headphones, cables, and batteries are not covered under warranty.
- Warranty only valid in the country or region of purchase.
- Your statutory rights are not affected.

Three Year Warranty

- All Datavideo products purchased after July 1st, 2017 are qualified for a free two years extension to the standard warranty, providing the product is registered with Datavideo within 30 days of purchase.
- Certain parts with limited lifetime expectancy such as LCD panels, DVD drives, Hard Drive, Solid State Drive, SD Card, USB Thumb Drive, Lighting, Camera module, PCIe Card are covered for 1 year.
- The three-year warranty must be registered on Datavideo's official website or with your local Datavideo office or one of its authorized distributors within 30 days of purchase.



Disposal

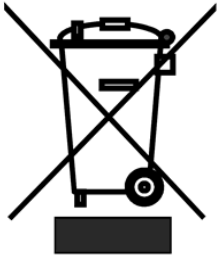

For EU Customers only - WEEE Marking

This symbol on the product or on its packaging indicates that this product must not be disposed of with your other household waste. Instead, it is your responsibility to dispose of your waste equipment by handing it over to a designated collection point for the recycling of waste electrical and electronic equipment. The separate collection and recycling of your waste equipment at the time of disposal will help to conserve natural resources and ensure that it is recycled in a manner that protects human health and the environment. For more information about where you can drop off your waste equipment for recycling, please contact your local city office, your household waste disposal service or the shop where you purchased the product.



CE Marking is the symbol as shown on the left of this page. The letters "CE" are the abbreviation of French phrase "Conformité Européene" which literally means "European Conformity". The term initially used was "EC Mark" and it was officially replaced by "CE Marking" in the Directive 93/68/EEC in 1993. "CE Marking" is now used in all EU official documents.

1. Introduction

Please take a few minutes to read this manual thoroughly to get more value out of your equipment as this will help you familiarise yourself with all aspects of the controller.

1.1 Features

- Remote control of up to four Pan, Tilt and Zoom cameras
- Pan, Tilt and Zoom with speed control by joystick
- Control of Pan, Tilt and Zoom as well as Iris, Focus, Gain, and other functions over Ethernet
- Multiple presets for pan/tilt settings for each individual camera
- Full remote control of each camera via serial communication over affordable network cabling
- Compatible with Datavideo's switcher tally indicators
- Compact design for easy installation
- Easy integration with Datavideo HD switchers for an affordable multi-camera solution.

1.2 Compatible Camera Models

Camera models compatible with the RMC-180 MARK II are provided in the list below.

- BC-80
- BC-200
- BC-200T
- PTC-140
- PTC-140NDI
- PTC-140T
- PTC-140TH
- PTC-150
- PTC-150T
- PTC-200
- PTC-200T
- PTC-280

1.3 Compatible Camera Control Protocol

Depending on your chosen PTZ camera(s), the following control protocols are available.

- SONY VISCA

Please note that a firmware update may be required to switch your RMC-180 MARK II to the same protocol as the camera you wish to control. All units are initially supplied with the VISCA protocol as this works with the Datavideo's Block/PTZ cameras.

1.4 System Diagrams

See the diagrams below for different example system setups.

PTC-280

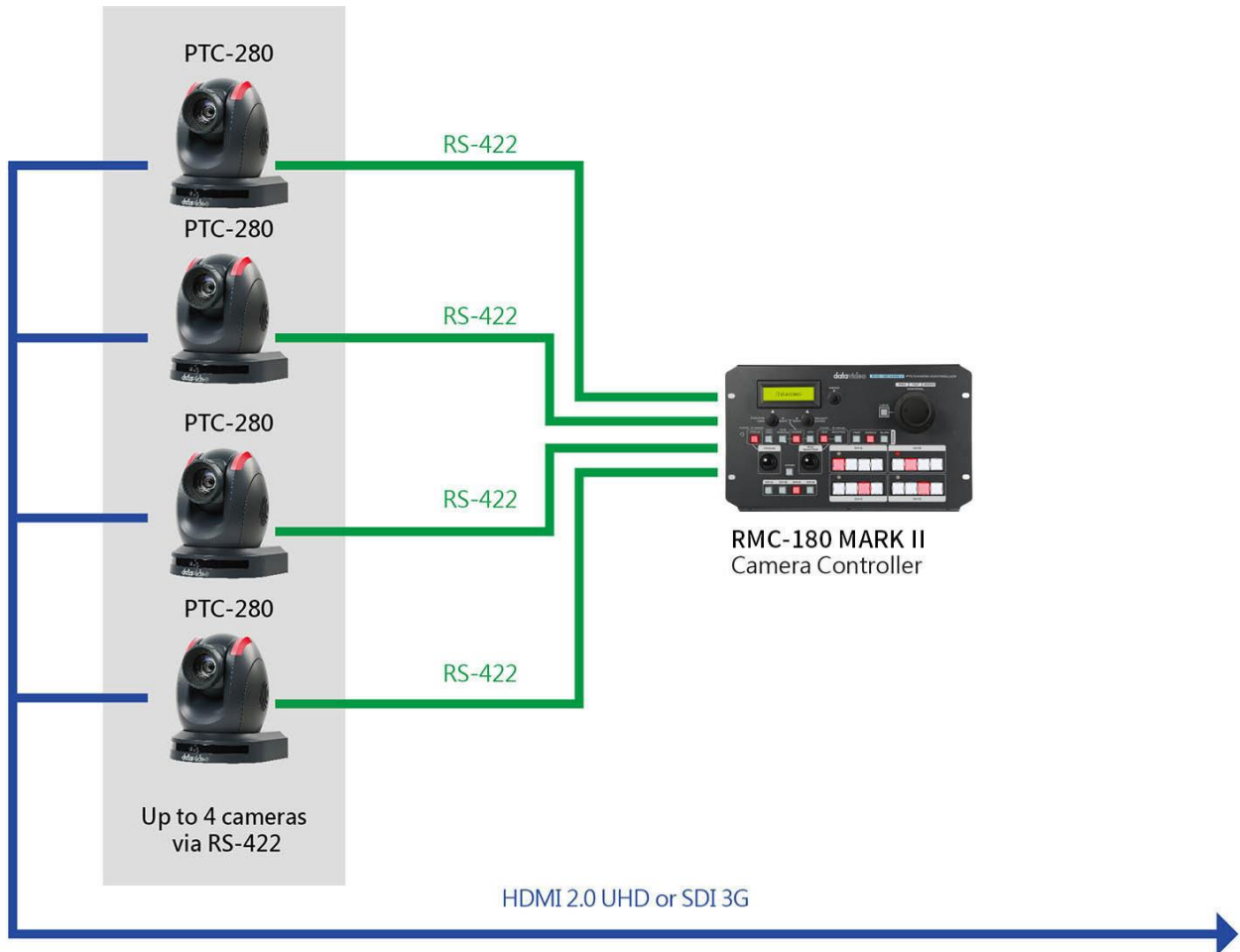

PTR-10

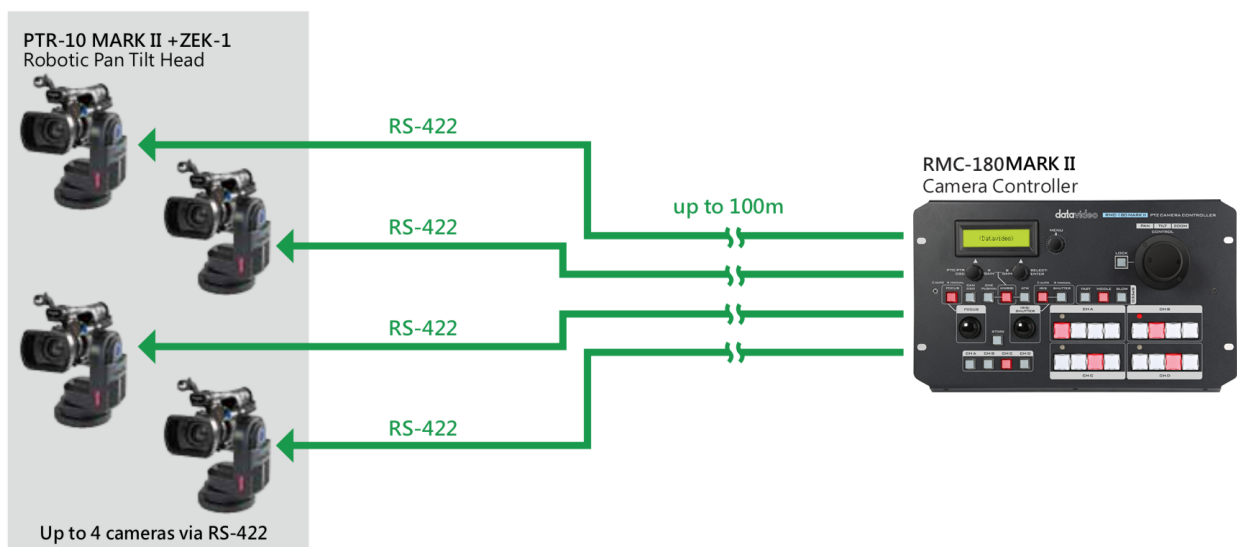

2. Connections and Controls

2.1 Front Panel – Keyboard

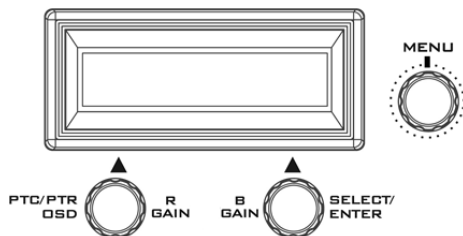
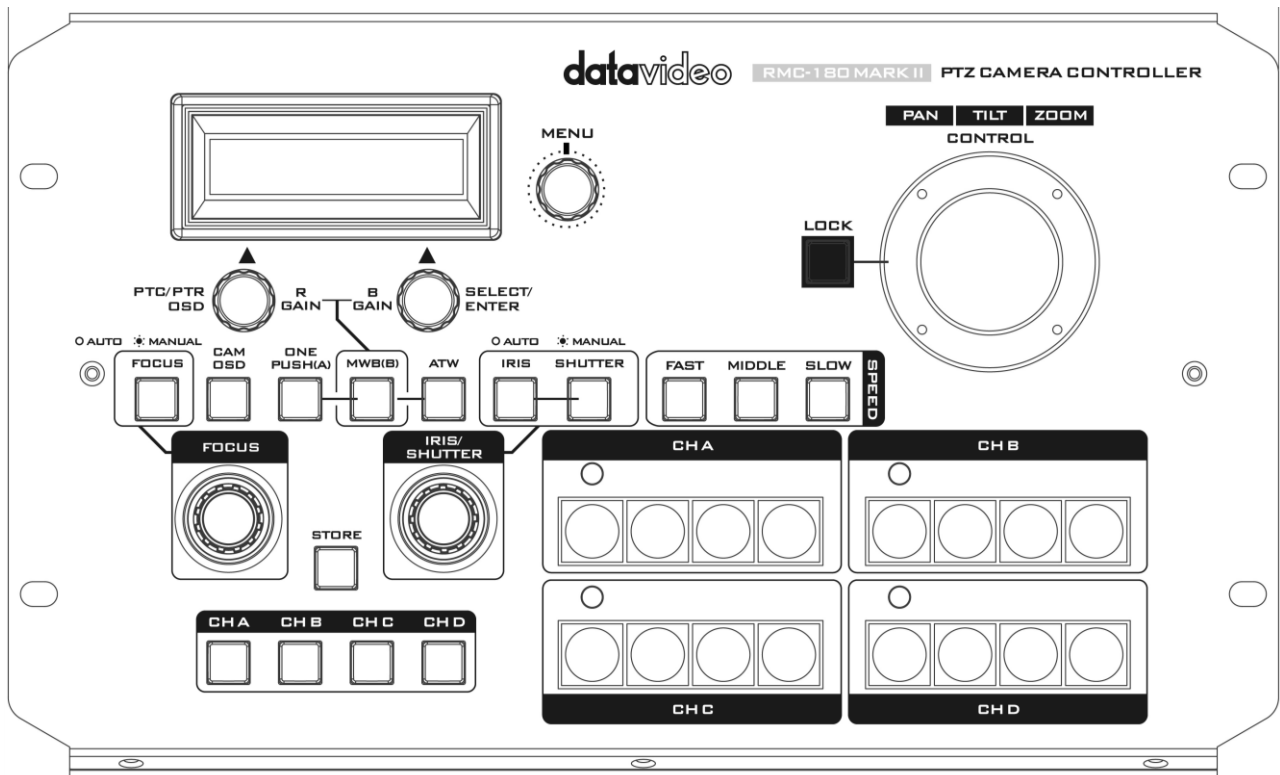

LCD Panel

The LCD panel displays device status as well as the activated OSD menu.

MENU dial

Press the **MENU** dial to activate the RMC-180 MARK II's setup menu (see [Menu Setup](#) for details) then rotate to scroll the menu up and down.

PTC/PTR dial

The **PTC/PTR** dial opens the OSD menu of PTC series cameras and PTR robotic pan tilt heads (See the corresponding user manuals for more information). Rotate to browse the menu.

SELECT/ENTER dial

The **SELECT/ENTER** dial can be used to select a particular menu option or modify the setting. Rotate to switch between options and push to select a specific item.

Note: The PTC/PTR and SELECT/ENTER dials can also be used to manually adjust R and B levels of the white balance settings. See *White Balance Mode Select* for more details.



CAM OSD

Press the **CAM OSD** button to display device status of the camcorder (Sony Z280) mounted on PTR-10/10T MAKR II.

Hold down the **CAM OSD** button for about 2 seconds to open the OSD menu of the camcorder (Sony Z280) mounted on PTR-10/10T MAKR II then rotate the **SELECT/ENTER** dial to browse the menu and push to make a selection.

Note: The device status and OSD menu opens on the monitor display connected to the camcorder. This button is designed for the camcorder mounted on PTR-10/10T MARK II; do not confuse this button with the PTC/PTR dial.



Channel A, B, C, D Buttons

To control or set up a connected camera, first select it by pressing its corresponding channel button. The selected channel button will be turned ON.

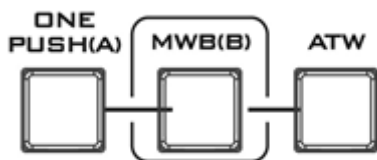

White Balance Mode Select

One Push (A) – One Push Auto Mode

The One Push White Balance mode is a fixed white balance mode that is automatically adjusted at the user's request. To enable this mode, hold down the button for about 3 seconds until it illuminates red.

The One Push White Balance data is lost when the power is turned off, in other words, turning off the device power resets the One Push White Balance setting.

The One Push White Balance mode can also be used for white balance calibration. Zoom in the camera lens on a white piece of paper which basically serves as a reference for what is white, then press the **ONE PUSH (A)** button to balance other colors accordingly.

Please note that if you are using the RMC-180 MARK II to control PTC-140 or PTC-280, the one push white balance process may require more time (up to 10 seconds) during which you should be refrained from using other functions.

MWB (B) – Manual Mode

Push the **MWB (B) button** to display the WB-B value on the LCD panel.

Hold down the **MWB (B) button** for about 2 seconds until the button turns blinking red then rotate the **R/B Gain dials to adjust the respective R and B levels**. As you rotate the dials, the new white balance settings will be immediately applied without having to push the dials to confirm the new settings.

If you pushed the dials accidentally, the MWB (B) button would turn solid red and you could hold down the button again for about 2 seconds to reactivate the manual mode.

You can also adjust the white balance manually on the OSD menu. For more information, see [FN9. R/B Gain Adj.](#)

ATW – Auto Mode

Push to enable auto white balance mode. Once enabled, the RMC-180 MARK II will adjust the selected camera's white balance settings automatically.

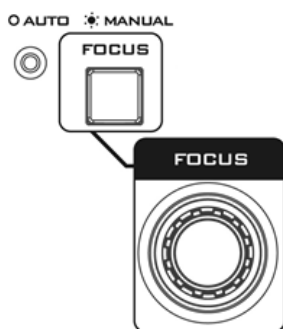

FOCUS

The **FOCUS** dial allows you to manually set the **focus**. Press the **FOCUS** button to activate the manual mode. The button LED illuminates **RED** to indicate that the manual mode is enabled (**AUTO LED turned OFF**). The **FOCUS** dial can then be rotated to set the focus.

If the **FOCUS** button is **OFF (AUTO LED turned ON)**, the camera is in **AUTO FOCUS** mode.

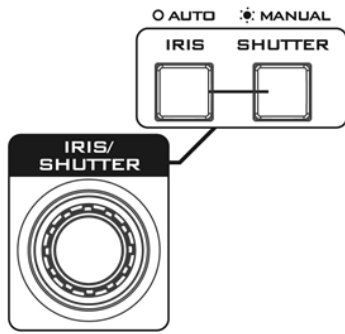

IRIS/SHUTTER

The **IRIS/SHUTTER** dial allows you to manually set the **iris and shutter speed**. Push the **IRIS and SHUTTER** buttons to switch between auto and manual modes. When the button LED illuminates **RED**, the manual mode is enabled. When the button LED illuminates **WHITE**, the auto mode is enabled.

The **IRIS** button is **ON (RED)** by default. If the **IRIS** button is disabled (**White**), the camera is in **AUTO EXPOSURE** mode.

The **SHUTTER** button is **OFF (Auto)** by default. Push to enable **manual mode** (the button illuminates red).

IRIS

The iris limits the amount of light that hits the image sensor. To manually set the iris, first make sure the **IRIS** button is **ON** then rotate the **IRIS/SHUTTER** dial right to increase the opening and left to decrease. The size of the opening should change as you rotate the dial.

Shutter Speed

A long exposure shot is created by decreasing the shutter speed and vice versa. The longer the exposure, the brighter your image will be and the shorter the exposure, the darker your image will be.

To manually adjust the shutter speed, first make sure the **SHUTTER** button is **ON**, then rotate the **IRIS/SHUTTER** dial right to increase the shutter speed and left to decrease. The shutter speed should change as you rotate the dial. Please note that you can also adjust the shutter speed using the OSD menu. See [FN10. Shutter Adj](#) for more information. Please note that the **SHUTTER** button will be **disabled** (the button illuminates white) if the shutter speed is not changed after 15 seconds.

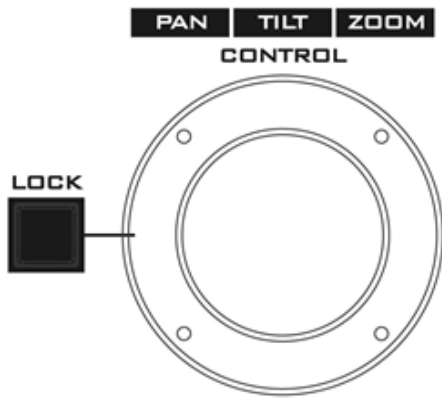

PTZ Joystick Control

Note: Before attempting to use the joystick to PAN, TILT or ZOOM a selected camera, first make sure the LOCK button is not enabled. If the LOCK button is ON, the joystick is locked; press the LOCK button to unlock the joystick.

PAN – Move the joystick left or right to pan the selected PTZ camera from left to right or vice versa.

TILT – Move the joystick up or down to tilt the selected PTZ camera up or down.

ZOOM – Twist the joystick clockwise (to the right) or anti-clockwise (to the left) to zoom in and out on the selected PTZ camera.

LOCK Button

When enabled, the joystick will be in the lock state. To resume its functional status, simply press the button once to unlock the joystick.

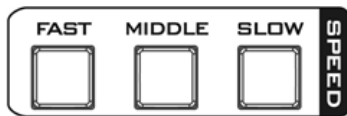

Speed

The speed at which the selected camera moves (pan, tilt and zoom) can be chosen by pressing one of the three speed buttons.



STR

Pressing this button enters the device into **STORE MODE**. When activated, this allows the current camera position to be stored in a chosen Channel Preset Button. Press again to exit **STORE MODE**.

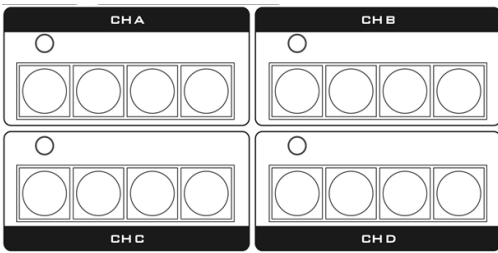

Channel Preset Buttons

These buttons may be used to store up to four camera positions for each camera. See [Section 4 Storing Different Camera Positions](#) for saving the camera's pan/tilt settings as well as the panel's button LED settings to the channel preset button.

To recall the stored pan/tilt settings, simply press the corresponding button. The button LED will illuminate when pressed.

Tally Indicator LEDs

Each set of the four preset buttons is assigned a Tally Indicator LED. This LED feature becomes active when the RMC-180 MARK II is connected to the tally output of a compatible Datavideo Switcher such as the SE-500HD or SE-650. For example, when the SE-500HD or SE-650 Switcher is sending camera A's video to the program output, the RMC-180 MARK II's channel A tally LED will be turned ON.

Please note that additional equipment and cabling will be required for such connection. See [Section 6 Tally Port](#) for more information about the port pinout.

2.2 Rear Panel – Connections

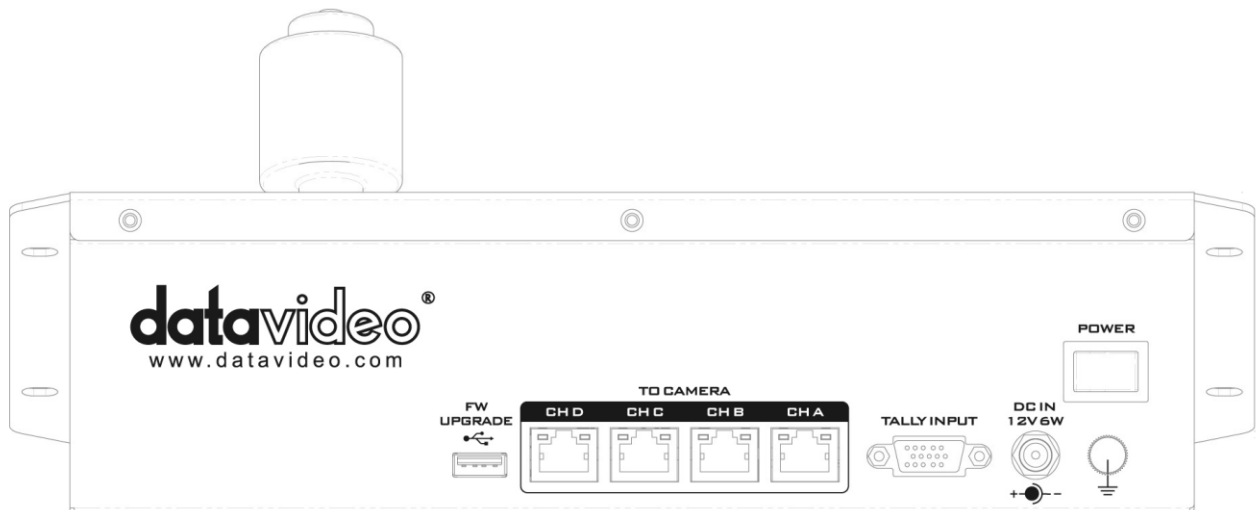

Firmware Upgrade

USB type A port for connection to a computer during the firmware upgrade process. See [Section 7 Firmware Upgrade Procedure](#) for more details.

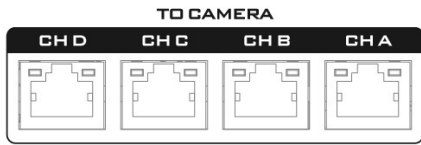

RJ-45 ports to connect cameras to channels A, B, C & D

Four RJ-45 ports are provided on the RMC-180 MARK II rear for connecting PTZ cameras. The interface standard is **RS-422** and uses any RJ-45 cable to connect the RMC-180 MARK II to the RS-422 port of the Block/PTZ camera. The cabling required needs to be custom-made and can be made by yourself or a competent technician. See [Section 5 RS-422 Pinout](#) for more information.

Note: Enable RS-422 connection mode on the Block/PTZ camera before connecting them to these channel ports. See the corresponding user manual for instructions.

Note: Max allowable cable length is 300 m.



Tally Input

The RMC-180 MARK II has the ability to receive tally signals from Datavideo Switchers such as the SE-500HD or SE-650. Upon receiving the video switcher's tally output signals, the corresponding Tally LED indicator on the RMC-180 MARK II Control Panel will be turned ON, giving the operator an indication of which camera is currently live at the switcher end.

The cabling required needs to be custom-made and can be made by yourself or a competent technician. See [Section 6 Tally Port](#) for more information about port pinout.

Note: Set the Tally LED Mode to Tally Input when this port is used. See [FN8. Tally LED MODE](#) for more information.



DC In Socket

Connect the supplied 12V 0.5A PSU to this socket. The connection can be secured by screwing the outer fastening ring of the DC In plug to the socket.

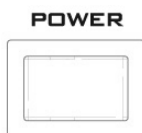

Power On/Off Switch

Switches the device ON / OFF.



Grounding Terminal

When connecting this unit to any other component, make sure that it is properly grounded by connecting this terminal to an appropriate point. When connecting, use the socket and be sure to use wire with a cross-sectional area of at least 1.0 mm².

3. Menu Setup

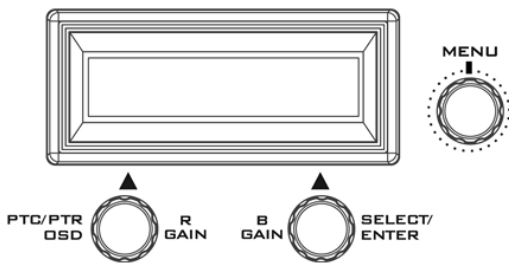

The LCD panel displays device status as well as the activated OSD menu.

Press the **MENU** dial to activate the RMC-180 MARK II's setup menu then rotate to scroll the menu up and down.

The **PTC/PTR** dial opens the OSD menu of PTC and PTR series cameras. Rotate to browse the menu.

The **SELECT/ENTER** dial can be used to select a particular menu option or modify the setting. Rotate to switch between options and push to select a specific item.

In this section, only the **RMC-180 MARK II's setup menu** is discussed.

FN1	Exit		
FN2	CAMERA ADDRESS	ADDR	81 82 83 84 85 86 87
FN3	JOYSTICK DIR	Pan	NORMAL REVERSE
		Tilt	NORMAL REVERSE
		ERROR	
FN4	VIDEO FORMAT		2160/60p 2160/59.94p 2160/50p 2160/30p 2160/29.97p 2160/25p 720/60p 720/59.94p 720/50p 1080/30p 1080/29.97p 1080/25p 1080/60i 1080/59.94i 1080/50i 1080/60p 1080/59.94p 1080/50p
FN5	POWER	ON	EXECUTE

		OFF	
FN6	SCREEN MODE	MIRROR	H+V
			H
			V
			OFF
FN7	MEMORY SPEED	SPD	1-18
FN8	TALLY LED MODE	TALLY USER	TALLY OFF
			TALLY RED
			TALLY GREEN
		TALLY INPUT	
FN9	R/B Gain Adj	R-G	00-FF (HEX)
		B-G	00-FF (HEX)
		WBAL. is not Manual	
FN10	Shutter Adj	PTC-280: 1/25 – 1/10000 PTC-140: 1/25 – 1/10000 PTC-150: 1/25 – 1/1250	
FN11	FIRMWARE VER.	Version	X.X
FN12	CAM INFO.	VENDOR ID	XXXX
		MB VER	XX.XX
		FPGA VER	XXX
		MOTOR VER	XX.XX
FN13	Backlight Adj	0	
		25	
		50	
		75	
		100	
FN14	Advanced Mode	ON	
		OFF	

FN1. EXIT

Exits the setup menu mode.

FN2. CAM ADDRESS

The camera address range is from 81 to 87.

Note: The camera address setting must match the VISCA ID setting of the Block/PTZ camera's DIP switch. For example, VISCA ID 1 corresponds to the camera address 81. See the corresponding user manuals for more information setting your cameras.

FN3. JOYSTICK DIR

FN3 sets the PAN and TILT directions.

PAN toggles the camera pan direction between NORMAL and REVERSE.

TILT toggles the camera tilt direction between NORMAL and REVERSE.

Note: An ERROR message will be displayed if the device fails to detect any camera device.

FN4. VIDEO FORMAT

Video output format selection. Available video output formats are:

- 2160/60p
- 2160/59.94p
- 2160/50p
- 2160/30p
- 2160/29.97p
- 2160/25p
- 720/60p
- 720/59.94p
- 720/50p
- 1080/30p
- 1080/29.97p
- 1080/25p
- 1080/60i
- 1080/59.94i
- 1080/50i
- 1080/60p
- 1080/59.94p
- 1080/50p

FN5. POWER

FN5 powers the selected Block/PTZ camera ON / OFF. While executing, the camera is either rebooting or shutting down.

FN6. SCREEN MODE

The screen mode allows the user to flip the selected camera image in different orientations listed as follows:

- H+V: Horizontal and vertical image flip
- H: Horizontal image flip
- V: Vertical image flip
- OFF: Normal

FN7. MEMORY SPEED

FN7 allows you to adjust the pan/tilt speeds of the pan/tilt settings stored in presets. The speed range is 1-18.

FN8. TALLY LED MODE

There are generally two tally LED modes, which are **Tally User** and **Tally Input**. The **Tally User** mode allows the user to directly control the camera tally light. In this mode, the user can toggle between **Tally Off**, **Tally Red** and **Tally Green**.

The **Tally Input** mode is selected when the RMC-180 MARK II is connected to the tally output of a compatible Datavideo Switcher such as the SE-500HD or SE-650. For example, when the SE-500HD or SE-650 Switcher is sending camera A's video to the program output, the RMC-180 MARK II's channel A tally LED will be turned ON.

FN9. R/B Gain Adj

FN9 allows the user to manually adjust the white balance setting. Press the MENU dial to open the OSD menu on the LCD display then browse to the R/B Gain Adjustment mode (FN9). Finally, adjust the R and B levels using the SELECT/ENTER dials and push the dial to apply the new settings.

Note: The R Gain and B Gain values range from 00-FF (Hex number).

“WBAL. Is not Manual” will be displayed on the LCD panel if the manual white balance mode is disabled.

FN10. Shutter Adj

This allows you to select the appropriate shutter speed for the selected camera from the list below.

- PTC-280: 1/25 – 1/10000
- PTC-140: 1/25 – 1/10000
- PTC-150: 1/25 – 1/1250

You can also adjust the shutter speed using the **IRIS/SHUTTER** dial. See the **IRIS/SHUTTER** dial descriptions for more information.

FN11. FIRMWARE VER.

FN11 displays the version of firmware installed on the RMC-180 MARK II.

FN12. CAM INFO.

FN12 displays camera information such as Vendor ID, mainboard firmware version, FPGA version, and motor version.

FN13. Backlight Adj

FN13 adjusts the brightness of channel preset buttons (shown below) **ONLY**. The five brightness values are 0 (darkest), 25, 50 (default), 75 and 100 (brightest).

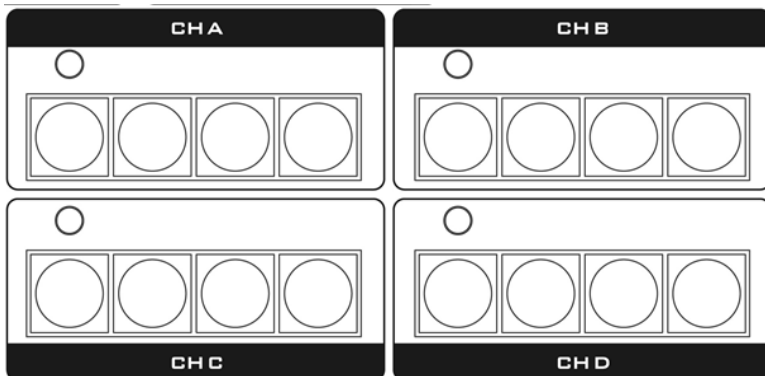

FN14. Advanced Mode

FN14 enables/disables the Advanced Mode. Once enabled, Channels A and C will merge to be Channel A; Channels B and D will merge to be Channel B. Both of which will then have up to 8 memory presets for saving pan/tilt settings. The table below shows the preset button assignments before and after the merge.

		Before	After			
CHA		Preset 1	Preset1	CHA		
		Preset2	Preset2			
		Preset3	Preset3			
		Preset4	Preset4			
CHC		Preset1	Preset5			
		Preset2	Preset6			
		Preset3	Preset7			
		Preset4	Preset8			
CHB		Preset1	Preset1	CHB		
		Preset2	Preset2			
		Preset3	Preset3			
		Preset4	Preset4			
CHD		Preset1	Preset5			
		Preset2	Preset6			
		Preset3	Preset7			
		Preset4	Preset8			

Note: After the Advanced Mode is enabled, the preset button should illuminate red and when activated, it should illuminate blue.

4. Storing Different Camera Positions

The RMC-180 MARK II allows you to store up to four camera positions (PAN/TILT) for each of the four possible cameras, CH A, B, C and D. This means, with four PTZ cameras connected to the RMC-180 MARK II, up to sixteen camera positions can be stored.

Note: Positions and other settings stored in the camera cannot be accessed by the RMC-180 MARK II.

To store a cameras position:

1. Select a camera first: CH A / CH B / CH C / CH D



2. Adjust the camera lens to the desired position or view using the joystick. Also set the focus, iris and zoom of the selected camera.
3. Push the **STORE** button which should illuminate red.



4. As soon as the corresponding four preset buttons of the selected camera channel start blinking, simply press a preset button to save the current PAN/TILT settings.

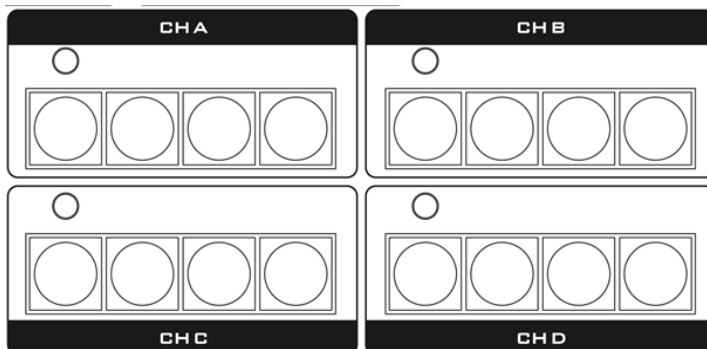

5. The selected preset button will remain ON for 2-3 seconds and the button LED will be turned OFF after the settings are successfully saved.

5. RS-422 Pinout

The RMC-180 MARK II PTZ Camera Controller is designed to control up to 4 Datavideo Block/Pan Tilt Zoom (PTZ) cameras such as the BC-200.

The four RJ-45 ports provided on the RMC-180 MARK II's rear panel serve to connect Block/PTZ cameras, thus allowing the user to use any RJ-45 cable to connect the RMC-180 MARK II to the RS-422 port on the Block/PTZ cameras. The communication protocol is VISCA.

Note: Enable RS-422 connection mode on the Block/PTZ camera before connecting them to these channel ports. See the corresponding user manual for instructions.

Direct Connection to Camera

To use the RMC-180 MARK II PTZ Camera Control Unit to directly control the Block/PTZ cameras, connect the RS-422 port on the camera to the RJ-45 port of the RMC-180 MARK II using any RJ-45 cable. The RS-422 wiring scheme is shown below.

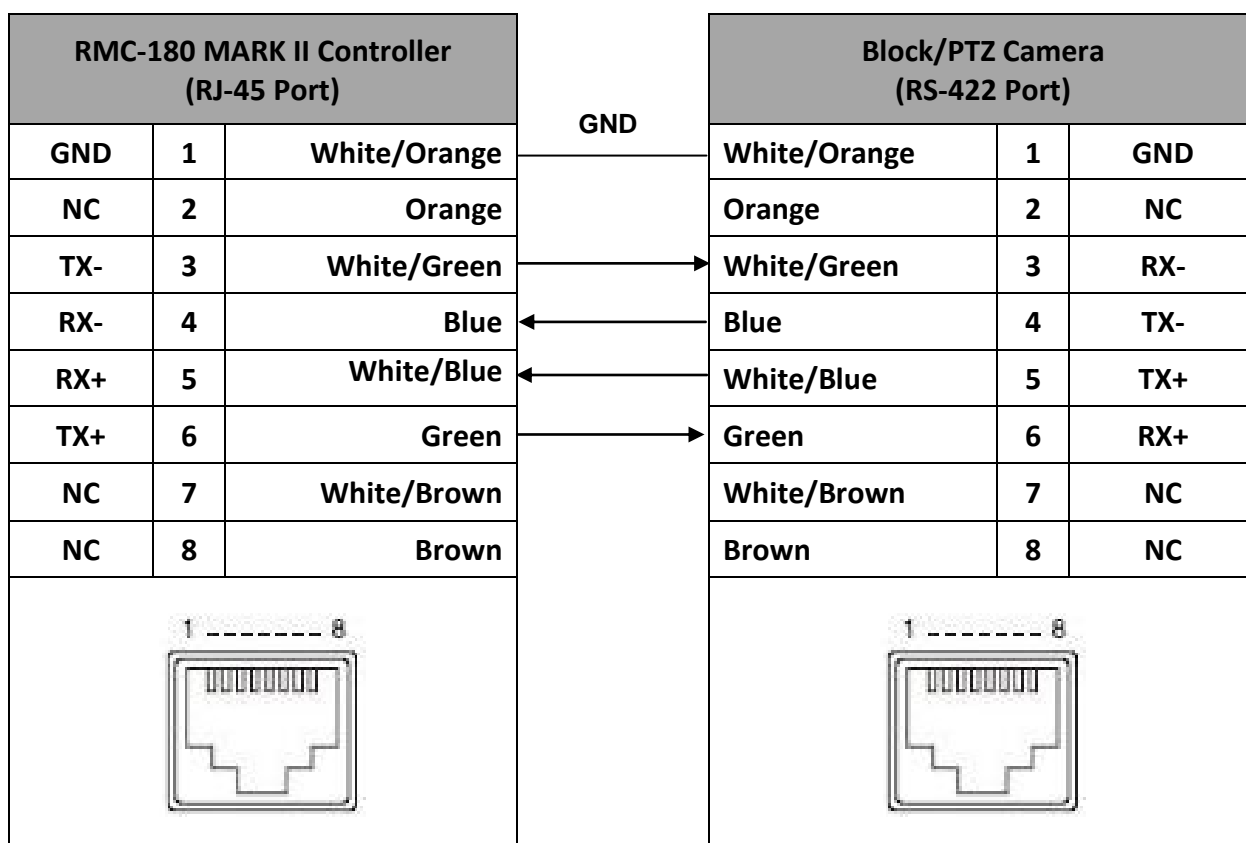

Connection to Camera via HBT-11

To use the RMC-180 MARK II PTZ Camera Control Unit to control the Block/PTZ cameras behind the HBT-11 Receiver Box, please connect the RMC-180 MARK II to the HBT-11 with the RS-422 wiring scheme as shown below. The cabling required needs to be custom-made and can be made by yourself or a competent technician. Please speak with your Dealer or local Datavideo office to get further help and advice.

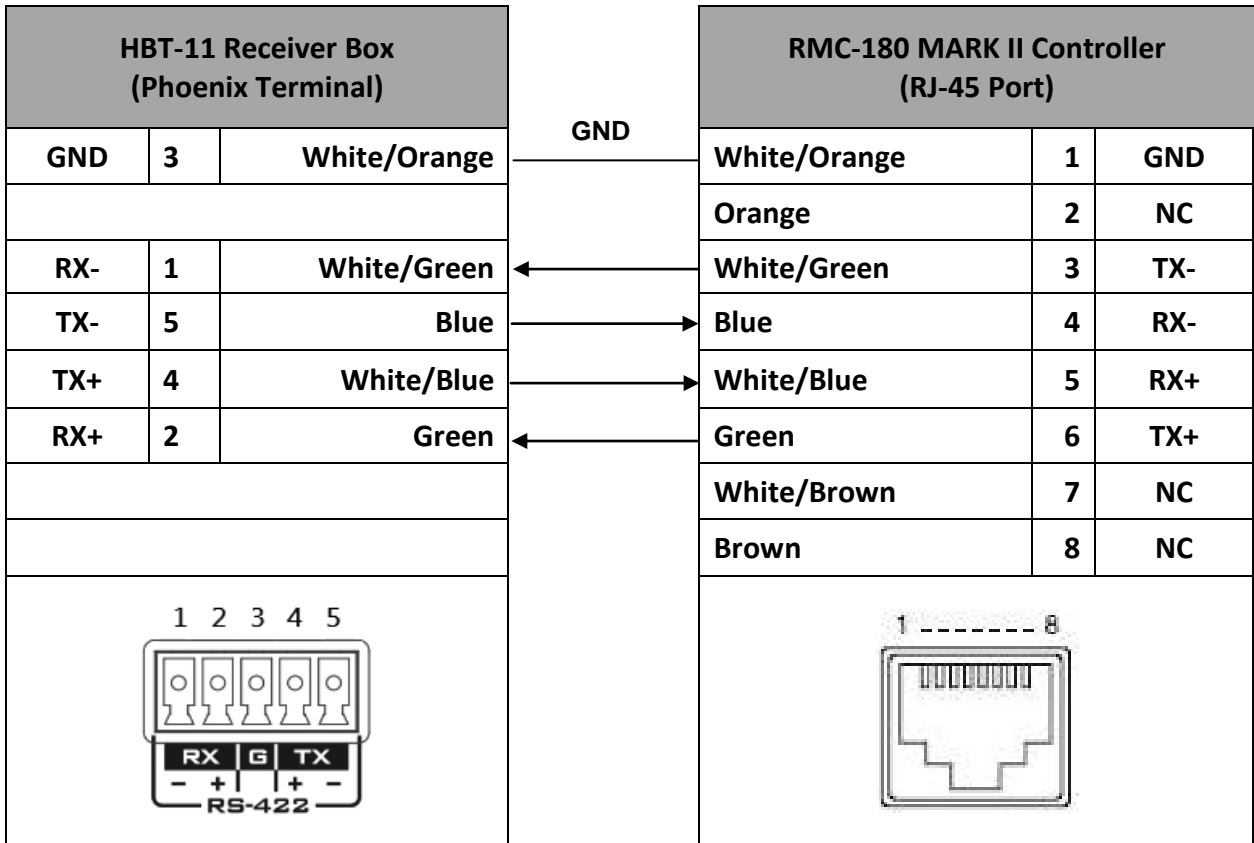

6. Tally Port

The RMC-180 MARK II has the ability to receive tally signals from Datavideo Switchers such as the SE-500HD or SE-650. Upon receiving the video switcher's tally output signals, the corresponding Tally LED indicator on the RMC-180 MARK II Control Panel will be turned ON, giving the operator an indication of which camera is currently live at the switcher end.

However, the cabling required needs to be custom-made and the port pinout is shown below.

Tally Port Pinout

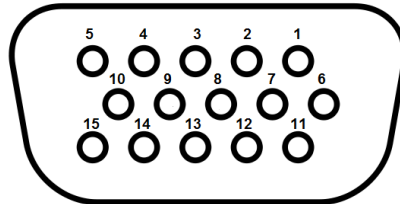

D-Sub 15-PIN Female

Channel	CH 1	CH 2	CH 3	CH 4
PGM Tally	PIN 1	PIN 6	PIN 11	PIN 5
PVW Tally	PIN 3	PIN 8	PIN 13	PIN 15
GND	PIN 4 / 9 / 14			

7. Firmware Upgrade Procedure

From time to time, Datavideo may release new firmware to either add new features or to fix reported bugs in the current RMC-180 MARK II firmware. Customers can update the firmware themselves if they wish or they can contact their local dealer or reseller for assistance should they prefer this method.

This section describes the firmware update process and it should take **approximately few minutes to complete**. Once started, **the update process should not be interrupted in any way** as this could result in a non-responsive unit.

Requirements

- Latest firmware files (bootloader and application firmware)
- A Male USB A to Male USB A cable not longer than 2 meters
- A Windows PC with USB 2.0 ports

Firmware

Follow the steps below to upgrade your device if the zip file contains only application firmware:

1. Connect a Male USB A to Male USB A cable between the USB firmware upgrade port on the device's rear panel and a USB port on the computer then turn on the RMC-180 MARK II's power.
2. Copy and paste the application firmware into the device

Name	Date modified	Type	Size
RMC180_PTC150_1v002	2015/5/14 下午0...	BIN 文件	76 KB

3. Reboot the RMC-180 MARK II and the LCD panel should show the following.

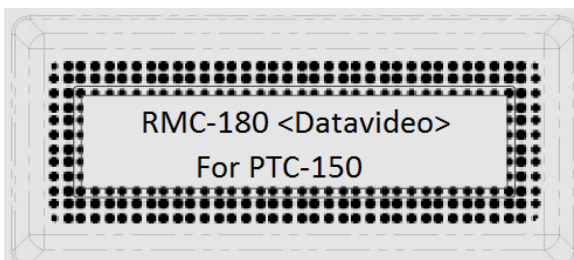

4. The RMC-180 MARK II is now ready for controlling the connected cameras.

Bootloader and Firmware

Follow the steps below to upgrade your device if the zip file contains bootloader file and application firmware:

1. Power off the RMC-180 MARK II and connect a Male USB A to Male USB A cable between the USB firmware upgrade port on the device's rear panel and a USB port on the computer.
2. One person switches on the device while another person holds down the buttons indicated with 

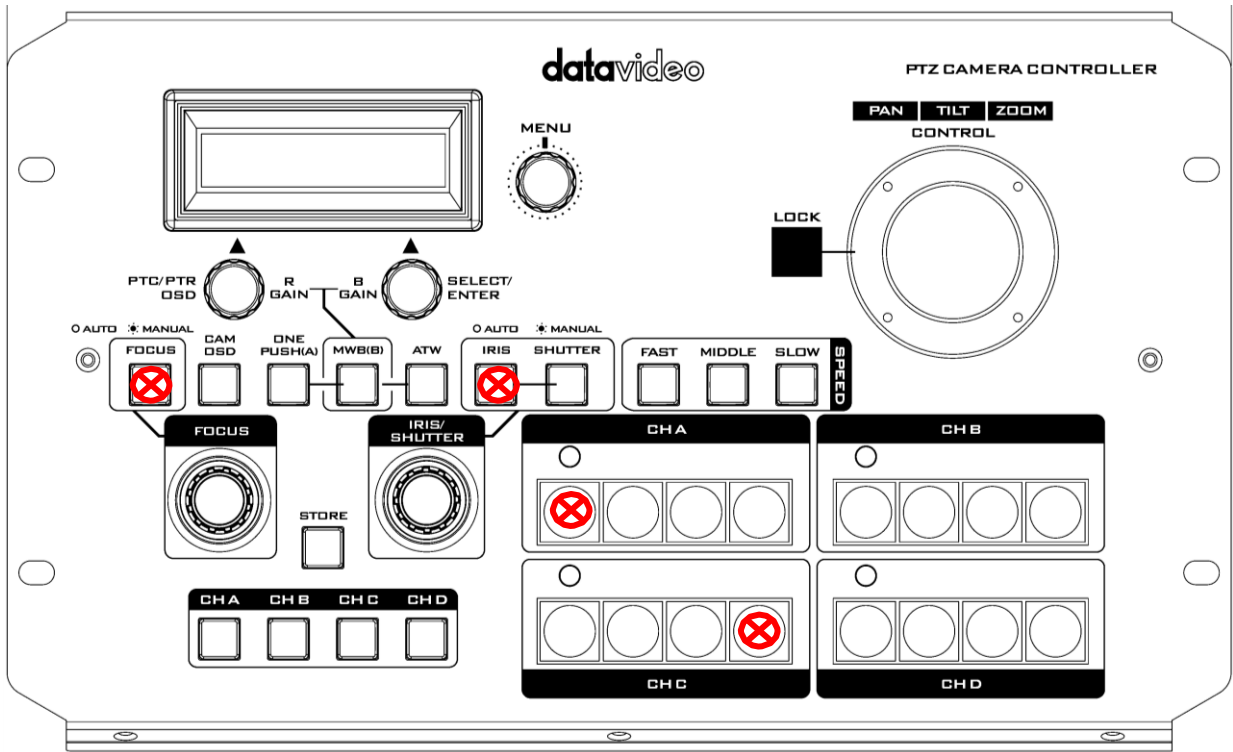

3. The user may release the buttons once the device's LCD panel displays the information below.

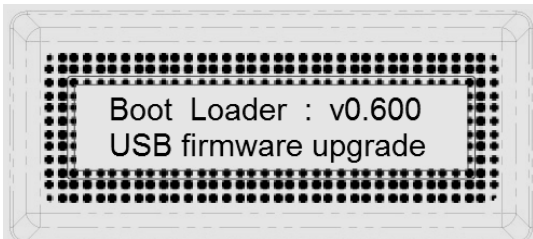

4. The RMC-180 MARK II (**RMC-180_U38**) will appear as a removable storage device on the PC as shown below.

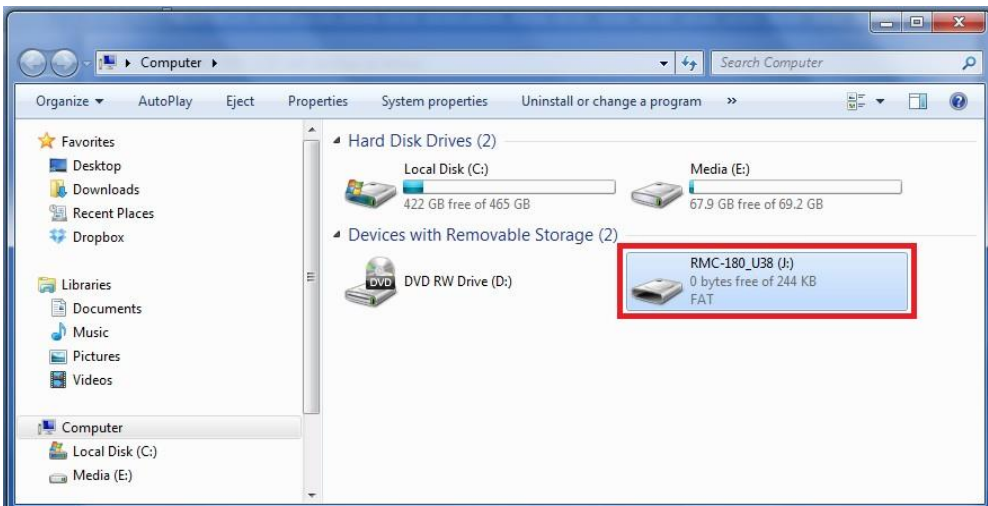

5. Double click the RMC-180_U38 removable storage device and delete the "bootcode.bin" file.
6. Copy and paste the latest bootloader file (bootcode.bin) into the RMC-180_U38 removable storage device.
7. Reboot the RMC-180 MARK II until the LCD panel displays the following:

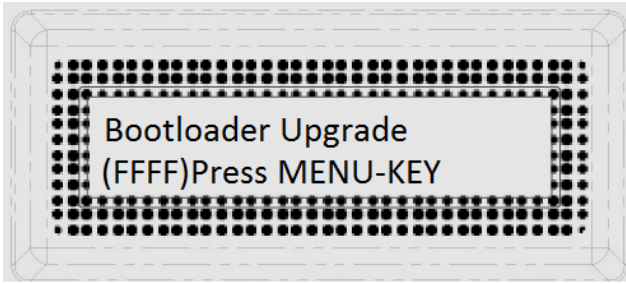

8. Press the MENU key to start the bootloader upgrade and do not disconnect the power before the upgrade is complete.

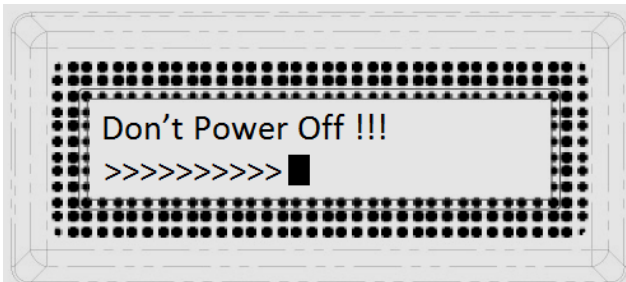

9. After the bootloader is upgraded, the LCD panel will show the following and the user may proceed to upgrading the application firmware.

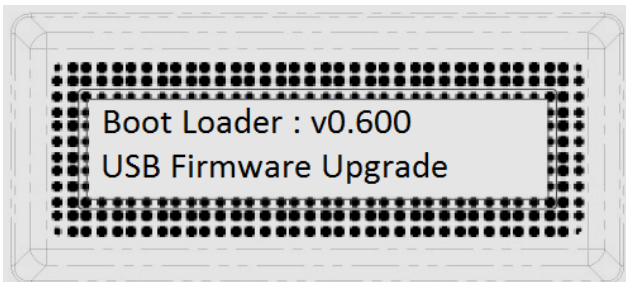

10. Remove bootcode.bin from the RMC-180 MARK II and copy and paste the application firmware into the device

Name	Date modified	Type	Size
 RMC180_PTC150_1v002	2015/5/14 下午 0...	BIN 文件	76 KB

11. Reboot the RMC-180 MARK II again and the LCD panel should show the following.

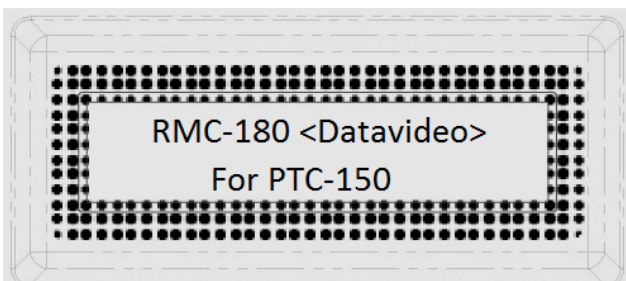

12. The RMC-180 MARK II is now ready for controlling the connected cameras.

8. Frequently-Asked Questions

This section describes problems that you may encounter while using RMC-180 MARK II. If you have any questions, please refer to related sections and follow all suggested solutions. If problem still exists, please contact your distributor or the service center.

No.	Problems	Solutions
1.	Press the CAM OSD button to open the OSD menu of the Sony Z280 camcorder mounted on the PTR-10/10T MARK II but the menu does not work.	Accidentally pressing the PTC/PTR OSD button while the OSD menu of the Sony Z280 is open will result in the OSD menu not working properly. To solve this issue, manually close the Sony Z280's OSD menu then reopen it.
2.	Menu functions such as R/B gain and shutter speed adjustments shown on the LCD screen work properly but the values are not shown.	This problem only occurs when controlling the Sony Z280 camcorder mounted on the PTR-10/10T MARK II from the RMC-180 MARK II.
3.	When controlling the Sony Z280 camcorder mounted on the PTR-10/10T MARK II from the RMC-180 MARK II, as I adjust the iris value after the shutter, it is still the shutter value that is changing.	After the shutter is adjusted, wait till the dialog box disappears before proceeding to adjusting the iris or else it will still be the shutter value that is changing. Note: This problem only occurs when controlling the Sony Z280 camcorder mounted on the PTR-10/10T MARK II from the RMC-180 MARK II.

9. Dimensions

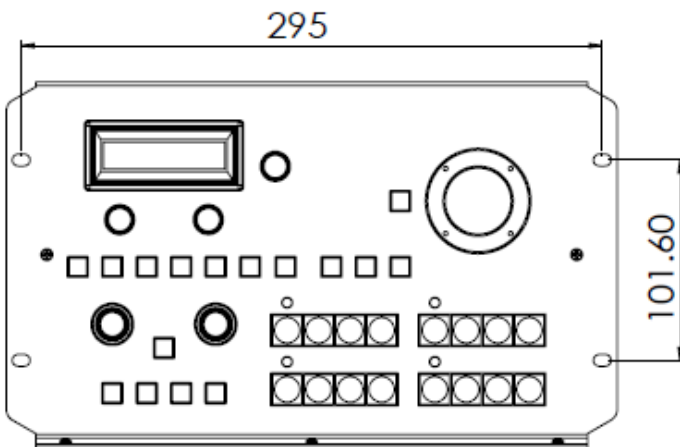
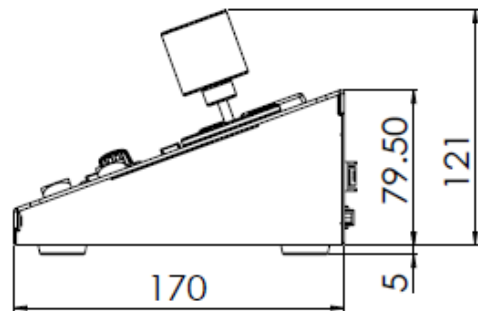
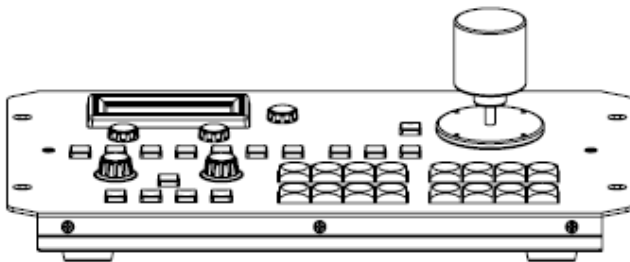
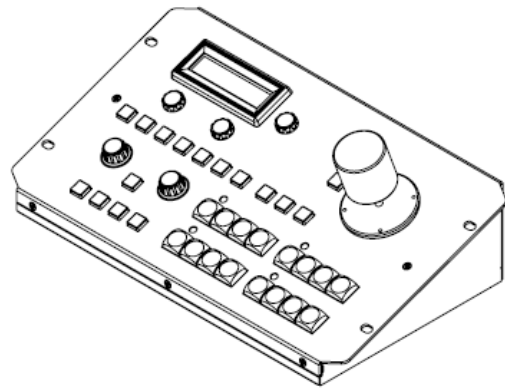
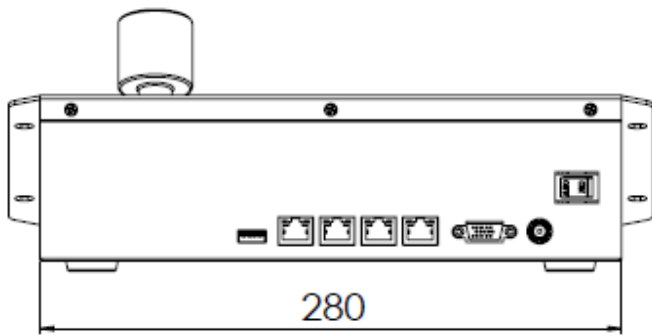

All measurements in millimeters (mm)

10. Specifications

Model	RMC-180 MARK II
Product Name	PTZ Camera Controller
Maximum Camera Control	4
Preset (Position)	4 for each camera (8 if only 2 camera channels are used)
Control Protocol	Sony VISCA
Control Interface	Serial RS-422
Connections to Camera	Point to Point
Firmware Upgrade Port	USB
Dimensions	310 x 170 x 125 mm
Weight	1.53 Kg
Power	DC 12V / 1A
Power Consumption	8W
Operating Temperature	0°C ~ 40°C
Storage Temperature	-40°C ~ 60°C

Service & Support

It is our goal to make owning and using Datavideo products a satisfying experience. Our support staff is available to assist you to set up and operate your system. Contact your local office for specific support requests. Plus, please visit www.datavideo.com to access our FAQ section.

Please visit our website for latest manual update.

www.datavideo.com/product/RMC-180 MARK II

datavideo
www.datavideo.com



@DatavideoUSA @DatavideoIndia2016
@DatavideoEMEA @Datavideojapan
@DatavideoTaiwan @DatavideoLatam
@DatavideoAsia @DatavideoBrasil



@Datavideo
@Datavideo_EMEA
@Datavideo_Taiwan



@DatavideoUSA
@DVTWDCN



@DatavideoUSA
@DatavideoEurope

All the trademarks are the properties of their respective owners.

Feb-08.2022
Version E4